

uponor

Tootekataloog 2020

Tarbevee, pörandakütte ja -jahutuse,
kohaliku soojusjaotuse lahendused



ÜHISED OMADUSED: ILMA ÜHENDUSMOODULITA:

- Automaatne tasakaalustus
- Lihtne kasutamine
- Kõikvõimalikeks lahendusteks ja erinevateks paigalduskohtades
- Laiendatav lisamooduliga

SIDEMOODULIGA:

- Kodus / eemal seadistus
- Andmete kogumine ja diagnostika
- Nutitelefoni kasutamine juhtpaneelina
- Lihtne kasutuselevõtt ja seadistamine. Kaughaldus nutitelefoni ja äpi abil
- Võimalus lubada kolmandate osapoolte ligipääs süsteemile (paigaldus- või hooldusettevõtte)
- Süsteemi teated ja alarmid reaalaajas
- Mitme eri paigalduse (näiteks linnakodu / suvila) juhtimine sama äpiga
- Ajaprogrammid
- Turvaline pilveühendus
- Automaatsed tarkvarauuendused interneti kaudu
- Integreeritud Targa Kodu ühendusvõimalused (näiteks Amazon Alexa)
- Avatud API lähtekood

JUHTMEVABA 24V

Komplektus	Ilma ühendusmoodulita	Ühendusmooduliga
Jahutus võimalik***	Ei	Jah
Kuni 6 termostaati ja 8 ajamit	Smatrix Wave Pulse X-265 	Smatrix Wave Pulse X-265 + R-208
Lisamoodul Lisaks 6 termostaati ja 6 ajamit	M-262 	M-262
Peamine ruumitermostaat	T-165 	T-169**
Valikulised ruumitermostaadid	T-161 	T-161
	T-166 	T-166
	T-169** 	T-165
	T-163 	T-163
Paigaldusraam	A-1XX Sobib toodetele T-163, T-165, T-166 	
Põranda-andur	S-1XX Sobib toodetele T-169, T-161, T-166, T-163 	

Termostaatide seadevahemik 5–35°C

* Plus X Award- innovatsiooniahind kvaliteedi, väljatöötamise, kasutusmugavuse ja ökoloogilisuse eest

** Jahutusrežiimiga süsteemides kasutage alati niiskusanduriga termostaate T-169, T-161, T-149

*** Ei sobi Uponor EPGj6 pumbarühmaga

JUHTMEVABA 24 V	Uponor-nr
X265 Kontroller Smatrix Wave Plus	1093021
X265 Kontroller ja ühendusmoodul R-208	1093024
M-262 Lisamoodul	1093133
T-165 Termostaat	1086980
T-161 Termostaat	1087815
T-166 Termostaat	1086982
T-169 Termostaat valge	1087816
T-169 Termostaat must	1087817
T-163 Termostaat avalikesse ruumidesse	1086979
R-208 Ühendusmoodul	1093030
A-1XX Paigaldusraam	1086986
S-1XX Põranda- ja välisandur	1071684

JUHTMEVABA STARDIPAKETT

S- kontroller X-265 + ühendusmoodul R-208+ 3 termostaati T-169
L- 2 kontrollerit X-265 + ühendusmoodul R-208+ 5 termostaati T-169
Stardipaketid ainult valgete termostaatidega!



JUHTMEGA 24 V

Komplektus	Modbus/KNX	Ilma ühendusmoodulita	Ühendusmooduliga
Jahutus võimalik ***	Jah***	Ei	Jah***
Kontroller Kuni 6 termostaati ja 8 ajamit	Smatrix Base PRO X-147 	Smatrix Base Pulse X-245 	Smatrix Base Pulse X-245 + R-208
Lisamoodul Lisaks 6 termostaati ja 6 ajamit	M-140 	M-242 	M-242
Peamine ruumitermostaat ja vajalikud lisaseadmed	T-149** 	T-145 	T-149**
	R-147 (KNX) 		
	I-147 (KNX) 		
Valikulised ruumitermostaadid	T-141 	T-141 	T-141
	T-146 	T-146 	T-146
	T-145 	T-149** 	T-145
	T-143 	T-143 	T-143
Paigaldusraam	A-1XX Sobib toodetele T-143, T-145, T-146 		
	Monteerimisraam A-14X Sobib termostaadile T-149 		
Põranda-andur	S-1XX Põranda-andur Sobib toodetele T-149, T-146, T-143 		

JUHTMEGA 24 V	Uponor-nr
X-245 Kontroller Smatrix Base Pulse	1093017
X-245 Kontroller Smatrix Base Pulse + R-208 ühendusmoodul	1093019
X-147 Kontroller Smatrix Base Pro	1087162
M-140 Kontrolleri lisamoodul	1071686
M-242 Kontrolleri lisamoodul	1093134
T-141 Termostaat	1087812
T-145 Termostaat	1086975
T-146 Termostaat	1086976
T-149 Termostaat valge	1087813
T-149 Termostaat must	1087814
T-143 Termostaat avalike ruumide jaoks	1086972
R-208 Ühendusmoodul	1093030
R-147 KNX-moodul	1087164
I-147 Juhtpaneel (KNX)	1087161
A-1XX Paigaldusraam	1086986
A-14X Monteerimisraam	1087821
S-1XX Põranda- ja välisandur	1071684

JUHTMEGA STARDIPAKETT

S- kontroller X-245 + ühendusmoodul R-208+ 3 termostaati T-149
L- 2 kontrollerit X-245 + ühendusmoodul R-208+ 5 termostaati T-149
Stardipaketid ainult valgete termostaatidega!



Spetsiaalselt Uponori paigaldajatele – korja uPointse ja saa auhindu!



Oled usaldanud meid ja meie tooteid. Meie soovime tänada – preemiaprogrammiga Uponor & More. Lihtsalt kogu uPointse ostes valitud Uponori tooteid ja saad valida suure hulga kingituste vahel.

See on nii lihtne: www.uponor-more.com/ee



1. Registreeri

Registreeri, et ühineda programmiga ja naudi erinevaid Uponor & More'i eeliseid!



2. Korja uPointse

uPointse saab paljude Uponori põhitoodete eest. Lihtsalt sisesta unikaalne kood Uponor & More veebilehel www.uponor-more.com/ee ja täida oma konto. Või skänni punktid Uponor PRO äpiga.



3. Vali auhindu

Nüüd Uponor & More programmi parima osa juurde! Kui oled kogunud piisavalt uPoints punkte, saad need vahetada põnevate kingituste vastu!



Uponor

Uponor Ecoflex Quattro Midi

Uus väiksema läbimõõduga eelisoleeritud toru kütte- ja sooja vee edastamiseks majast majja.

Tavatorust 20%
soodsam hind

Quattro Midi eelised:

- ✓ 14% väiksem soojuskadu
- ✓ 15% parem painduvus
- ✓ Mugavam transport, sest väiksem rull

Sisukord

1. Uponor komposiittorusüsteemid	3–33
1.1 Torud	3–6
1.2 Liitmikud	8–25
1.3 RS- moodulliitmikud	26–29
1.4 UNI-X ja UNI-C kollektorid	30–33
2. Uponor Flex plasttorusüsteemid	34–56
2.1 PEX torud	34–37
2.2 Liitmikud QjaE	38–49
2.3 Aqua Plus lekkekindel veesüsteem	50–54
3. Uponor põrandakütte- ja jahutussüsteemid	57–123
3.1 Põrandaküttetorud	57–59
3.2 Põrandakütte paigaldussüsteemid	60–71
3.3 Kollektorid ja kollektorkapid	72–77
3.4 Pealevooluautomaatika (pumbagrupid)	78–90
3.5 Põrandakütte ruumitemperatuuriautomaatika (kontrollerid, termostaadid, andurid)	91–116
3.6 Ajamid	117–119
4. Uponor elektriline põrandaküte	124–128
5. Uponor eelisooleeritud torud ja liitmikud	129–152
6. Uponor ventilatsioon	153–158
7. Uponor Port, soojasõlmed	159–167
8. Uponor tööriistad	168–179

Lühendid

Lühendid	Pakend	Nimetus
A	[m ²]	pindala
č c	[mm]	telgede vahe
č č	[mm]	tsenter - tsentri kaugus 1
d	[mm]	läbimõõt
d1	[mm]	läbimõõt 1
d2	[mm]	läbimõõt 2
d3	[mm]	läbimõõt 3
DN	[mm]	nominaalläbimõõt
G	[kN/m ²]	kandevõime
h	[mm]	kõrgus
h1	[mm]	kõrgus 1
h2	[mm]	kõrgus 2
KA	[d]	kuivamisaeeg päevades
kulu	[l/m ²]	kulu
l	[mm]	pikkus
L	[m]	pikkus meetrites
l1	[mm]	pikkus 1
p/a	[W]	võimsus ajami kohta
p	[bar]	rõhk
P	[W]	tegelik võimsus
R-arv	[m ² K/W]	soojustakistus
s	[mm]	paksus / seina paksus
SK	[°]	sisekeere
SK	[-]	sisekeere (meeterkeere)
TP	[V]	toitepinge
Tüüp	[-]	tüüp
ÜK	[mm]	ülekate
V	[l/m]	mahutavus
väljundid	[-]	väljundite arv
värvus	[-]	värvus
VK_m	[-]	väliskeere (meeterkeere)
VK	[°]	väliskeere
w	[mm]	laius
W	[m]	laius
w1	[mm]	laius 1
w2	[mm]	laius 2
Kaal	[kg]	ühiku kaal
z	[mm]	z arv
ΔLw	[dB]	löögimüra sumbumine

Uponor Uni Pipe PLUS



Uponor Uni Pipe PLUS on unikaalne keevituseta alumiiniumkihiga komposiit-toru kasutamiseks tarbevee-, kütte- ja jahutussüsteemides.

Eelised

- Kevvituseta alumiiniumkiht.
- Hea kujustabiilsus, väike joonpaisumine
- Parendatud paindumus
- 100% hapniku difusioonikindel
- Kerge



Kirjeldus

- Hapniku difusioonikindel mitmekihiline komposiit-toru (PE-RT - sidekiht – keevituseta alumiinium - sidekiht - PE-RT).
- Toodetud SACP-tehnoloogia kohaselt.
- Tuleklass E vastavalt EN 13501-1.
- Hügieeniliselt suletud otstega vastavalt EN 806.

Kasutusala

- Testitud/hea kiidetud vastavalt EN ISO 21003, kasutusklass 1,2,4,5/10bar
- Tarbevesi: püsiv töötemperatuur 0°C kuni 70°C maksimaalsel püsival rõhul 10 bar. Lühiajaline avariitemperatuur 95°C kuni 100 tundi kasutusaja jooksul.
- Küte: püsiv töötemperatuur kuni 80°C maksimaalsel püsival rõhul kuni 10 bar. Lühiajaline avariitemperatuur 100°C kuni 100 tundi kasutusaja jooksul.

Uponor Uni Pipe PLUS valge S

- latt

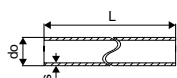

Art. nr.	Dimension	L do s m mm mm	2. pak.	pakend UOM
1059572	16x2,0 5m	5 16 2,0	125	5 m
1059573	20x2,25 5m	5 20 2,25	85	5 m
1059574	25x2,5 5m	5 25 2,5	55	5 m
1059575	32x3,0 5m	5 32 3	35	5 m

Uponor MLC toru valge S

- latt

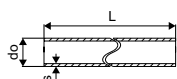

Art. nr.	Dimension	L do s m mm mm	2. pak.	pakend UOM
1013446	40x4,0 5m	5 40 4,0	20	5 m
1013449	50x4,5 5m	5 50 4,5	20	5 m
1013451	63x6,0 5m	5 63 6,0	15	5 m
1013453	75x7,5 5m	5 75 7,5	5	5 m
1013455	90x8,5 5m	5 90 8,5	5	5 m
1013457	110x10,0 5m	5 110 10,0	5	5 m

Uponor Uni Pipe PLUS

Uponor Uni Pipe PLUS valge

■ rull

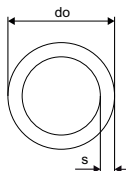

Art. nr.	Dimension	L m	do mm	s mm		2. pak.	pakend	UOM
1059577	16x2,0 200m	200	16	2		900	2600	200 m
1059579	20x2,25 100m	100	20	2,25		700	1300	100 m
1059581	25x2,5 50m	50	25	2,5		800	700	50 m
1059583	32x3,0 50m	50	32	3		1000	400	50 m

Uponor MLC isoleeritud

Kirjeldus

- Koosneb torust ja isolatsioonikihist.
- Rullides.
- Ekstrusiooni teel valmistatud isolatsioon on valmistatud suletud pooridega vahtpolüetüleenist.
- Kaetud tugeva kilekattega

Uponor Uni Pipe PLUS valge toru sinise isolatsiooniga S6 WLS 040

Isolatsiooni paksus 6 mm

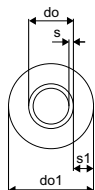

NEW
NEW
NEW

Art. nr.	Dimension	L m	do mm	do1 mm	s mm	s1 mm	värvus	uPoints	2. pak.	pakend	UOM
1091723	16x2,0 blue 75m	75	16	28	2,0	6,0	sinine		700	600	75 m
1091724	20x2,25 blue 75m	75	20	32	2,25	6,0	sinine		900	600	75 m
1091725	25x2,5 blue 50m	50	25	37	2,5	6,0	sinine		1050	400	50 m

Uponor Uni Pipe PLUS

Uponor Uni Pipe PLUS kaitsehülsis

Kirjeldus

toru kaitsehülsis

rullites

hülsstoru materjal : gofreeritud polüetüleen

Uponor Uni Pipe PLUS valge toru, sinises ja punases hülsis

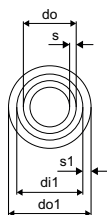

Art. nr.	Dimension	L m	di1 mm	do mm	do1 mm	s mm	värvus -	uPoints	2. pak.	pakend	UOM
1063061	16x2,0 - 25/20 red 75m	75	20	16	25	2,0	punane	500	1350	75	m
1063059	16x2,0 - 25/20 blue 75m	75	20	16	25	2,0	sinine	500	1350	75	m
1063062	20x2,25 - 28/23 red 75m	75	23	20	28	2,25	punane	800	900	75	m
1063060	20x2,25 - 28/23 blue 75m	75	23	20	28	2,25	sinine	800	900	75	m

Uponor Metallic Pipe PLUS



Uponor Metallic Pipe PLUS on unikaalne krooniläikelise pinnaga komposiittoru. Tänu kõrge viimistlusastme-ga välispinnale sobib ideaalselt nähtavaks paigalduseks.

Eelised

- Sarnaneb väliselt metalltorule
- Keevituseta alumiiniumkiht
- Hea kujupüsivus
- Kerge: lihtne käsitleda ja paigaldada



Kirjeldus

- Hapniku difusioonikindel mitmekihiline komposiittoru (PE-RT - sidekiht – keevituseta alumiinium - pinnakate) . Krooniläikelise pinnaga. Toodetud SACP tehnoloogia kohaselt.
- Tuleklass E vastavalt EN 13501-1.
- Hügieeniliselt suletud otstega vastavalt EN 806.

Kasutusala

- Tarbevesi: püsiv töötemperatuur 0°C kuni 70°C maksimaalsel püsival rõhul 10 bar. Lühiajaline avariitemperatuur 95°C 100 tundi kasutusaja jooksul.
- Küte: püsiv töötemperatuur kuni 80°C maksimaalsel püsival rõhul kuni 10 bar. Lühiajaline avariitemperatuur 100°C 100 tundi kasutusaja jooksul.

Uponor Metallic Pipe PLUS S

- Metallic Pipe PLUS

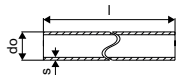

Art. nr.	Dimension	L	do	s	2. pak.	pakend	UOM
		m	mm	mm			
1088400	16x2,0 3m	3	16	2,0	75	3	m
1088401	20x2,25 3m	3	20	2,25	48	3	m

Uponor Uni

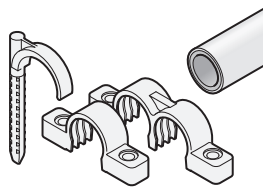

Uponor torude kinnitusklambrid

Eelised

- Kiire paigaldus
- Lihtne kasutada



Uponor Teck hülsi klamber

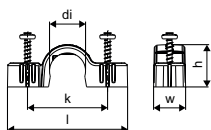

Art. nr.	Dimension	l	di	h	k	w	värvus	2. pak.	pakend	UOM
1063472	25mm	67	25	28	47	16	valge	600	100	tk
1063474	28mm	70	28	31	50	16	valge	600	100	tk

Uponor Teck hülsi kaksikklamber

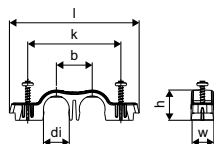

Art. nr.	Dimension	l	di	b	h	k	w	värvus	2. pak.	pakend	UOM
1063473	25mm	105	25	32	28	80	16	valge	360	60	tk
1063475	28mm	111	28	35	31	86	16	valge	360	60	tk

Uponor MLC toruklamber, valge



Art. nr.	Dimension	d	2. pak.	pakend	UOM
1083931	16-20	16-20	10	1	tk
1083932	25-32	25-32	10	1	tk

Uponor MLC toru kaksikklamber, valge



Art. nr.	Dimension	d	ε c	2. pak.	pakend	UOM
1083933	16-20	16-20	40	10	1	tk
1083934	25-32	25-32	60	10	1	tk

Uponor S-Press PLUS

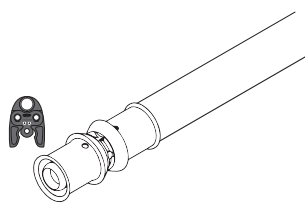

S-Press PLUS on uus pressliitmike põlvkond, mis tagab kestvad toruühendused. Ühildub 100% olemasolevate Uponor komposiitorude ja tööriistadega. Läbimõõtu- dele 16 kuni 32 mm. Nii metall- kui ka plastliitmikud.

Eelised

- **TUGEV:** talub ka raskeimaid tingimusi
- **OHUTU:** tagab perfektse pressimistulemuse
- **LIHTNE:** lihtsustab projekteerimist ja paigaldamist
- **NUTIKAS:** Presshülslil oleva QR koodi abil kiire ligipääs tehnilisele infole



Kirjeldus

- Roostevabast terasest presshülss, kontrollavaga
- Täpne presspea asendi fikseerimine liitmikul
- Unikaalne pressimisindikaator
- Liitmiku läbimõõdu kiire tuvastamine
- Lekkeindikatsiooniga liitmikud
- Kiire 3-töövõttega paigaldus
- 100% sobivus olemasolevate Uponor komposiitorudega
- Innovaatiline QR kood kiireks juurdepääsuks digiandmetele

Kasutusala

- Tarvevesi: püsiv töötemperatuur 0°C kuni 70°C maksimaalsel püsival rõõhul 10 bar. Lühiajaline avariitemperatuur 95°C 100 tundi kasutusaja jooksul.
- Küte: püsiv töötemperatuur kuni 80°C maksimaalsel püsival rõõhul 10 bar. Lühiajaline avariitemperatuur 100°C 100 tundi kasutusaja jooksul.

Sertifitseerimine

- DVGW
- AENOR

Uponor S-Press PLUS/ S-Press, materjal PPSU

Kirjeldus

- Parendatud volutakistusega plastliitmikud, materjal PPSU

Uponor S-Press PLUS põlv PPSU

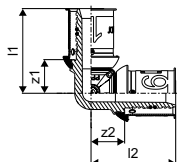

Art. nr.	Dimension	I1 mm	I2 mm	1 mm	2 mm	2. pak.	pakend	UOM
NEW 1039929	16-16	33	33	13	13	80	10	tk
NEW 1039930	20-20	37	37	16	16	80	10	tk
NEW 1039931	25-25	48	48	19	19	40	5	tk
NEW 1039932	32-32	51	51	23	23	20	5	tk

Uponor S-Press PLUS

Uponor S-Press põlv PPSU

■ Värvkood

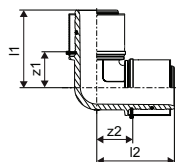

Art. nr.	Dimension	l1 mm	l2 mm	z1 mm	z2 mm	pakend	UOM
1046386	40-40	68	68	29	29	5	tk
1046387	50-50	73	73	34	34	3	tk
1032877	63-63	101	101	40	40	1	tk
1032878	75-75	108	108	47	47	1	tk

Uponor S-Press PPSU

■ Värvkood

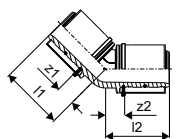

Art. nr.	Dimension	l1 mm	l2 mm	z1 mm	z2 mm	pakend	UOM
1032879	63-63	83	83	23	23	1	tk
1032880	75-75	86	86	25	25	1	tk

Uponor S-Press PLUS jätk PPSU

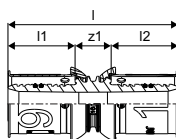

Art. nr.	Dimension	l mm	l1 mm	l2 mm	z mm	2. pak.	pakend	UOM
1039933	16-16	51	20	20	11	80	10	tk
1039934	20-20	54	21	21	11	80	10	tk
1039935	25-25	68	28	28	11	40	5	tk
1039936	32-32	69	28	28	13	40	5	tk

Uponor S-Press plastjätk PPSU

■ Värvkood

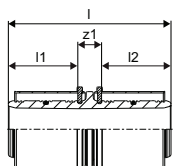
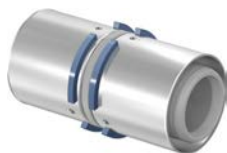

Art. nr.	Dimension	l mm	l1 mm	l2 mm	z mm	pakend	UOM
1046401	40-40	91	39	39	13	5	tk
1046402	50-50	91	39	39	13	3	tk
1032881	63-63	137	61	61	15	1	tk
1032882	75-75	137	61	61	15	1	tk

Uponor S-Press PLUS

Uponor S-Press PLUS siirdmik PPSU

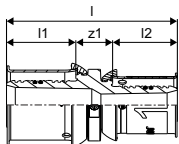

NEW
NEW
NEW
NEW

Art. nr.	Dimension	l mm	l1 mm	l2 mm	z mm	2. pak.	pakend	UOM
1039937	20-16	53	21	20	11	80	10	tk
1039938	25-16	60	28	20	11	40	5	tk
1039939	25-20	61	28	21	11	40	5	tk
1039940	32-25	69	28	28	13	40	5	tk

Uponor S-Press siirdmik PPSU

■ Värvkood

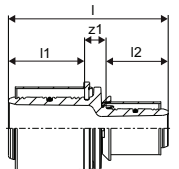

NEW
NEW
NEW
NEW
NEW
NEW
NEW
NEW

Art. nr.	Dimension	l mm	l1 mm	l2 mm	z mm	pakend	UOM
1039941	40-25	80	39	28	12	5	tk
1039942	40-32	80	39	28	13	5	tk
1039943	50-32	80	39	28	13	3	tk
1046406	50-40	91	39	39	13	3	tk
1032883	63-40	115	61	37	17	1	tk
1032884	63-50	115	61	37	17	1	tk
1032885	75-50	115	61	37	17	1	tk
1032886	75-63	137	61	59	17	1	tk

Uponor S-Press PLUS kolmik PPSU

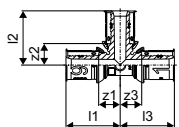

NEW
NEW
NEW
NEW

Art. nr.	Dimension	l1 mm	l2 mm	l3 mm	z1 mm	z2 mm	z3 mm	2. pak.	pakend	UOM
1039944	16-16-16	33	33	33	13	13	13	80	10	tk
1039945	20-20-20	37	37	37	16	16	16	40	10	tk
1039946	25-25-25	48	48	48	19	19	19	20	5	tk
1039947	32-32-32	51	51	51	23	23	23	20	5	tk

Uponor S-Press kolmik PPSU

■ Värvkood

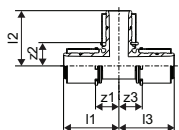

NEW
NEW
NEW
NEW

Art. nr.	Dimension	l1 mm	l2 mm	l3 mm	z1 mm	z2 mm	z3 mm	pakend	UOM
1046390	40-40-40	68	68	68	29	29	29	5	tk
1046391	50-50-50	73	73	73	33	33	33	3	tk
1032887	63-63-63	101	101	101	42	40	42	1	tk
1032888	75-75-75	108	107	108	47	47	47	1	tk

Uponor S-Press PLUS

Uponor S-Press PLUS erikolmik PPSU

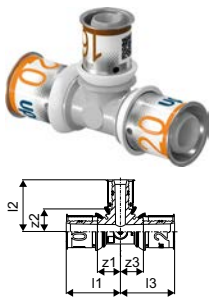

Art. nr.	Dimension	I1 mm	I2 mm	I3 mm	z1 mm	z2 mm	z3 mm	2. pak.	pakend	UOM
NEW 1039948	16-20-16	35	35	35	15	13	15	40	10	tk
NEW 1039949	20-16-16	37	36	36	16	16	16	40	10	tk
NEW 1039950	20-16-20	37	36	37	16	16	16	40	10	tk
NEW 1039951	20-20-16	37	37	36	16	16	16	40	10	tk
NEW 1039952	20-25-20	41	48	41	19	19	19	40	10	tk
NEW 1039953	25-16-16	48	39	39	19	19	19	40	5	tk
NEW 1039954	25-16-20	48	39	41	19	19	19	40	5	tk
NEW 1039955	25-16-25	48	39	48	19	19	19	40	5	tk
NEW 1039956	25-20-20	48	41	41	19	19	19	40	5	tk
NEW 1039957	25-20-25	48	41	48	19	19	19	40	5	tk
NEW 1039958	32-16-32	51	43	51	23	23	23	40	5	tk
NEW 1039959	32-20-32	51	44	51	23	23	23	40	5	tk
NEW 1039960	32-25-25	51	51	51	23	23	23	40	5	tk
NEW 1039961	32-25-32	51	51	51	23	23	23	40	5	tk

Uponor S-Press erikolmik PPSU



Art. nr.	Dimension	I1 mm	I2 mm	I3 mm	z1 mm	z2 mm	z3 mm	pakend	UOM
NEW 1039962	40-20-40	68	49	68	29	28	29	5	tk
NEW 1039963	40-25-32	68	56	56	29	28	28	5	tk
NEW 1039964	40-25-40	68	56	68	29	28	29	5	tk
NEW 1039965	40-32-32	68	56	56	29	28	28	5	tk
NEW 1039966	40-32-40	68	56	68	29	28	29	5	tk
NEW 1039967	50-25-40	73	61	73	34	33	34	3	tk
NEW 1039968	50-25-50	73	61	73	34	33	34	3	tk
NEW 1039969	50-32-50	73	61	73	34	33	34	3	tk

Uponor S-Press plast erikolmik PPSU

■ Värvkood

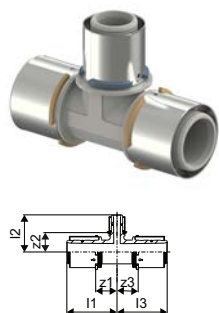

Art. nr.	Dimension	I1 mm	I2 mm	I3 mm	z1 mm	z2 mm	z3 mm	pakend	UOM
NEW 1046400	50-40-50	73	73	73	33	33	33	3	tk
NEW 1032889	63-25-63	101	68	101	40	39	40	1	tk
NEW 1032890	63-32-63	101	68	101	40	39	40	1	tk
NEW 1032891	63-40-63	101	79	101	40	40	40	1	tk
NEW 1032892	75-32-75	108	74	108	47	45	47	1	tk
NEW 1032893	75-40-75	108	86	108	47	44	47	1	tk
NEW 1032894	75-50-75	108	86	108	47	49	47	1	tk

Uponor S-Press PLUS

Uponor S-Press PLUS

Kirjeldus

- Parendatud voolutakistusega korpus
- Tsingikaota DR messing

Uponor S-Press PLUS otsik väliskeere

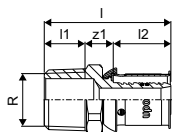

NEW
NEW
NEW
NEW
NEW
NEW
NEW
NEW
NEW

Art. nr.	Dimension	l mm	l1 mm	l2 mm	R "	z mm	2. pak.	pakend	UOM
1070502	16-R1/2"MT	44	14	20	1/2	10	80	10	tk
1070503	16-R3/4"MT	46	16	20	3/4	11	120	15	tk
1070504	20-R1/2"MT	45	14	21	1/2	10	80	10	tk
1070505	20-R3/4"MT	48	15	21	3/4	11	80	10	tk
1070506	20-R1"MT	54	17	21	1	16	40	10	tk
1070507	25-R3/4"MT	55	15	28	3/4	11	40	5	tk
1070508	25-R1"MT	62	18	28	1	16	40	5	tk
1070509	32-R1"MT	62	17	28	1	16	40	5	tk
1070510	32-R1 1/4"MT	66	19	28	1 1/4	19	20	5	tk

Uponor S-Press PLUS otsik väliskeere

- keere vastavalt EN ISO 228-1

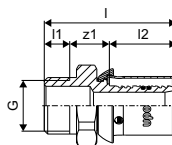

NEW

Art. nr.	Dimension	l mm	l1 mm	l2 mm	R "	z mm	2. pak.	pakend	UOM
1091728	16-G3/8"MT	39	8	20	3/8	12	80	10	tk

Uponor S-Press otsik väliskeere

- Tinatud messing
- Värvkood

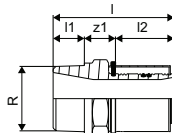

NEW
NEW
NEW
NEW
NEW

Art. nr.	Dimension	l mm	l1 mm	l2 mm	R "	z mm	d mm	pakend	UOM
1046901	40-R1 1/4"MT	78	20	38	1 1/4	20		5	tk
1046902	40-R1 1/2"MT	80	20	38	1 1/2	22	40	5	tk
1046905	50-R1 1/2"MT	80	20	38	1 1/2	22	50	3	tk
1032895	63-R2"MT	111	28	61	2	22		1	tk
1032896	75-R2 1/2"MT	110	27	61	2 1/2	22		1	tk

Uponor S-Press PLUS

Uponor S-Press PLUS otsik sisekeere

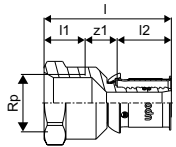

NEW
NEW
NEW
NEW
NEW
NEW
NEW
NEW

Art. nr.	Dimension	l mm	l1 mm	l2 mm	Rp "	z mm	2. pak.	pakend	UOM
1070515	16-Rp1/2"FT	47	15	20	1/2	12	80	10	tk
1070516	20-Rp1/2"FT	47	15	21	1/2	10	120	15	tk
1070517	20-Rp3/4"FT	51	16	21	3/4	14	80	10	tk
1070518	20-Rp1"FT	52	19	21	1	12	80	20	tk
1070519	25-Rp3/4"FT	56	17	28	3/4	11	40	5	tk
1070520	25-Rp1"FT	59	19	28	1	12	40	5	tk
1070521	32-Rp1"FT	58	20	28	1	10	40	5	tk
1070522	32-Rp1 1/4"FT	62	21	28	1 1/4	13	20	5	tk

Uponor S-Press otsik sisekeere

- Tinatatud messing
- Värvikood

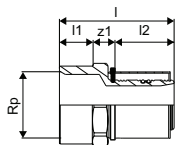

NEW
NEW
NEW

Art. nr.	Dimension	l mm	l1 mm	l2 mm	Rp "	z mm	pakend	UOM
1046903	40-Rp1 1/4"FT	73	21	38	1 1/4	14	5	tk
1046904	40-Rp1 1/2"FT	77	21	38	1 1/2	18	5	tk
1046907	50-Rp1 1/2"FT	73	21	38	1 1/2	14	3	tk

Uponor S-Press PLUS põlv

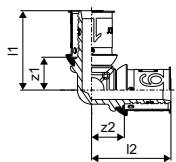

NEW
NEW
NEW
NEW

Art. nr.	Dimension	l1 mm	l2 mm	z1 mm	z2 mm	2. pak.	pakend	UOM
1070523	16-16	34	34	14	14	80	10	tk
1070524	20-20	37	37	16	16	80	10	tk
1070525	25-25	47	47	19	19	40	5	tk
1070526	32-32	51	51	23	23	20	5	tk

Uponor S-Press PLUS

Uponor S-Press põlv

- Tinatatud messing
- Värvkood

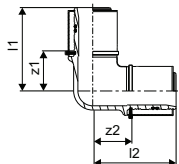

NEW
NEW

Art. nr.	Dimension	l1 mm	l2 mm	z1 mm	z2 mm	pakend	UOM
1046908	40-40	72	72	34	34	5	tk
1046911	50-50	79	79	41	41	3	tk

Uponor S-Press PLUS põlv väliskeere

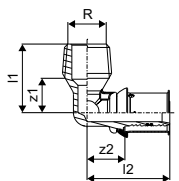

NEW
NEW
NEW
NEW
NEW
NEW

Art. nr.	Dimension	l1 mm	l2 mm	R "	z1 mm	z2 mm	2. pak.	pakend	UOM
1070532	16-R1/2"MT	30	37	1/2	15	17	80	10	tk
1070533	20-R1/2"MT	32	41	1/2	15	19	80	10	tk
1070534	20-R3/4"MT	34	41	3/4	18	19	80	10	tk
1070535	25-R3/4"MT	36	48	3/4	20	19	40	5	tk
1070536	25-R1"MT	43	51	1	22	23	40	5	tk
1070537	32-R1"MT	43	51	1	22	23	20	5	tk

Uponor S-Press põlv väliskeere

- Tinatatud messing
- Värvkood

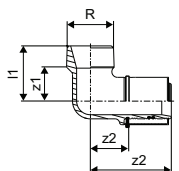

NEW

Art. nr.	Dimension	l1 mm	l2 mm	R "	z1 mm	z2 mm	pakend	UOM
1046909	40-R1 1/4"MT	49	72	1 1/4	30	34	5	tk

Uponor S-Press PLUS

Uponor S-Press PLUS põlv sisekeere

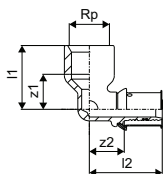

Art. nr.	Dimension	l1 mm	l2 mm	Rp "	z1 mm	z2 mm	2. pak.	pakend	UOM
1070539	16-Rp1/2"FT	33	38	1/2	18	18	80	10	tk
1070540	20-Rp1/2"FT	36	41	1/2	21	19	80	10	tk
1070541	20-Rp3/4"FT	36	43	3/4	19	22	40	10	tk
1070542	25-Rp3/4"FT	40	50	3/4	23	22	20	5	tk
1070543	25-Rp1"FT	45	54	1	25	26	20	5	tk
1070544	32-Rp1"FT	49	54	1	30	26	20	5	tk

Uponor S-Press põlv sisekeere

- Tinatatud messing
- Värvkood

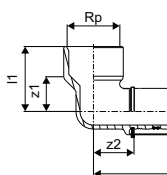

Art. nr.	Dimension	l1 mm	l2 mm	Rp "	z1 mm	z2 mm	pakend	UOM
1046910	40-Rp1 1/2"FT	59	75	1 1/2	38	37	5	tk
1046912	50-Rp1 1/2"FT	59	79	1 1/2	38	41	3	tk

Uponor S-Press PLUS jätk

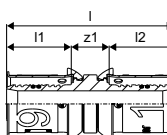

Art. nr.	Dimension	l mm	l1 mm	l2 mm	z mm	2. pak.	pakend	UOM
1070547	16-16	51	20	20	12	80	10	tk
1070548	20-20	54	21	21	12	80	10	tk
1070549	25-25	68	28	28	12	40	5	tk
1070550	32-32	68	28	28	12	40	5	tk

Uponor S-Press jätk

- Tinatatud messing
- Värvkood

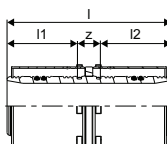

Art. nr.	Dimension	l mm	l1 mm	l2 mm	z mm	pakend	UOM
1046932	40-40	88	38	38	12	5	tk
1046935	50-50	88	38	38	12	3	tk

Uponor S-Press PLUS

Uponor S-Press PLUS siirdmik

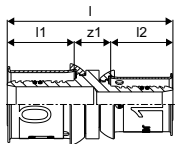

NEW
NEW
NEW
NEW
NEW

Art. nr.	Dimension	l mm	l1 mm	l2 mm	z mm	2. pak.	pakend	UOM
1070552	20-16	53	21	20	12	80	10	tk
1070553	25-16	60	28	20	12	40	5	tk
1070554	25-20	61	28	21	12	40	5	tk
1070555	32-20	61	28	21	12	40	5	tk
1070556	32-25	68	28	28	12	40	5	tk

Uponor S-Press siirdmik

- Tinatatud messing
- Värvkood

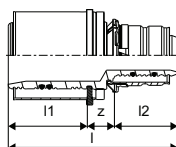

NEW
NEW
NEW
NEW

Art. nr.	Dimension	l mm	l1 mm	l2 mm	z mm	pakend	UOM
1046930	40-25	81	38	30	13	5	tk
1046931	40-32	81	38	30	13	5	tk
1046933	50-32	81	38	30	13	3	tk
1046934	50-40	89	38	38	14	3	tk

Uponor S-Press PLUS kolmik

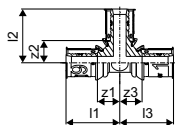

NEW
NEW
NEW
NEW

Art. nr.	Dimension	l1 mm	l2 mm	l3 mm	z1 mm	z2 mm	z3 mm	2. pak.	pakend	UOM
1070560	16-16-16	34	34	34	14	14	14	80	10	tk
1070561	20-20-20	37	37	37	16	16	16	40	10	tk
1070562	25-25-25	47	47	47	19	19	19	20	5	tk
1070563	32-32-32	51	51	51	23	23	23	20	5	tk

Uponor S-Press kolmik

- Tinatatud messing
- Värvkood

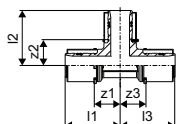

NEW
NEW

Art. nr.	Dimension	l1 mm	l2 mm	l3 mm	z1 mm	z2 mm	z3 mm	pakend	UOM
1046921	40-40-40	72	72	72	34	34	34	5	tk
1046928	50-50-50	79	79	79	41	41	41	3	tk

Uponor S-Press PLUS

Uponor S-Press PLUS erikolmik

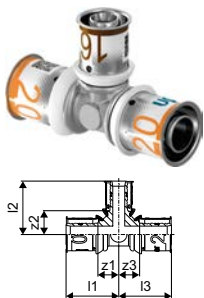

Art. nr.	Dimension	I1	I2	I3	Z1	Z2	Z3	2. pak.	pakend	UOM	
		mm	mm	mm	mm	mm	mm				
NEW	1070566	16-20-16	36	37	36	16	16	16	80	10	tk
NEW	1070567	20-16-16	35	36	34	14	16	14	40	10	tk
NEW	1070568	20-16-20	35	36	35	14	16	14	80	20	tk
NEW	1070569	20-20-16	37	37	36	16	16	16	80	20	tk
NEW	1070570	20-25-16	40	47	38	19	19	19	40	10	tk
NEW	1070571	20-25-20	40	47	40	19	19	19	40	10	tk
NEW	1070572	25-16-16	44	38	36	16	19	17	40	5	tk
NEW	1070573	25-16-20	44	38	38	16	19	17	40	5	tk
NEW	1070574	25-16-25	42	38	42	14	19	14	20	5	tk
NEW	1070575	25-20-16	44	40	36	16	19	17	40	5	tk
NEW	1070576	25-20-20	44	40	38	16	19	17	40	5	tk
NEW	1070577	25-20-25	44	40	44	16	19	16	20	5	tk
NEW	1070578	25-25-16	47	47	38	19	19	19	20	5	tk
NEW	1070579	25-32-25	50	48	50	22	20	22	20	5	tk
NEW	1070580	32-16-32	43	42	43	15	22	15	20	5	tk
NEW	1070581	32-20-32	45	43	45	17	22	17	20	5	tk
NEW	1070582	32-25-25	48	50	48	20	22	20	20	5	tk
NEW	1070583	32-25-32	48	50	48	20	22	20	20	5	tk

Uponor S-Press erikolmik

- Tinatatud messing
- Värvkood

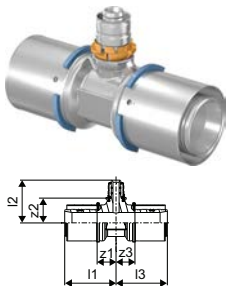

Art. nr.	Dimension	I1	I2	I3	Z1	Z2	Z3	pakend	UOM	
		mm	mm	mm	mm	mm	mm			
NEW	1046916	40-20-40	60	50	60	22	28	22	5	tk
NEW	1046917	40-25-32	61	60	53	23	30	23	5	tk
NEW	1046918	40-25-40	61	60	61	23	30	23	5	tk
NEW	1046919	40-32-32	65	60	57	27	30	26	5	tk
NEW	1046920	40-32-40	65	60	65	27	30	27	5	tk
NEW	1046924	50-25-40	61	65	61	23	35	23	3	tk
NEW	1046925	50-25-50	61	65	61	23	35	23	3	tk
NEW	1046926	50-32-50	65	65	65	27	35	27	3	tk
NEW	1046927	50-40-50	72	79	72	34	41	34	3	tk

Uponor S-Press PLUS kolmik väliskeere

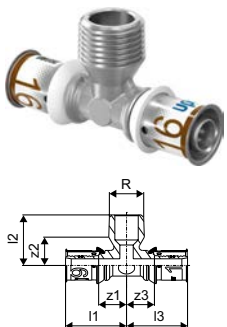

Art. nr.	Dimension	I1	I2	I3	R	Z1	Z2	Z3	2. pak.	pakend	UOM	
		mm	mm	mm	mm	mm	mm	mm				
NEW	1070592	16-R1/2"MT-16	38	30	38	1/2	18	15	18	40	10	tk
NEW	1070593	25-R3/4"MT-25	48	36	48	3/4	19	21	19	20	5	tk
NEW	1070594	32-R3/4"MT-32	48	40	48	3/4	19	25	19	20	5	tk

Uponor S-Press PLUS

Uponor S-Press PLUS kolmik sisekeere

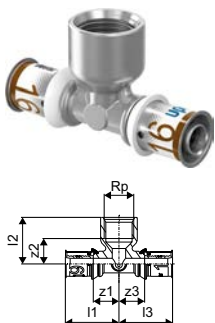

NEW
NEW
NEW
NEW
NEW
NEW
NEW

Art. nr.	Dimension	l1	l2	l3	Rp	z1	z2	z3	2. pak.	pakend	UOM
		mm	mm	mm	„	mm	mm	mm			
1070595	16-Rp1/2"FT-16	38	33	38	1/2	18	18	18	40	10	tk
1070596	20-Rp1/2"FT-20	40	35	40	1/2	19	20	19	60	15	tk
1070597	20-Rp3/4"FT-20	43	37	43	3/4	22	20	22	40	10	tk
1070598	25-Rp1/2"FT-25	48	37	48	1/2	19	22	19	20	5	tk
1070599	25-Rp3/4"FT-25	50	40	50	3/4	22	23	22	20	5	tk
1070600	32-Rp1/2"FT-32	47	40	47	1/2	18	25	18	20	5	tk
1070601	32-Rp3/4"FT-32	51	44	51	3/4	23	27	23	20	5	tk

Uponor S-Press kolmik sisekeere

- Tinatatud messing
- Värvkood

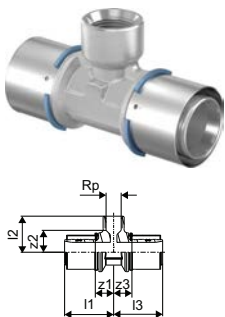

NEW
NEW

Art. nr.	Dimension	l1	l2	l3	Rp	z1	z2	z3	pakend	UOM
		mm	mm	mm	„	mm	mm	mm		
1046923	40-Rp3/4"FT-40	64	47	64	3/4	26	31	26	5	tk
1046929	50-Rp1"FT-50	72	56	72	1	34	37	34	3	tk

Uponor S-Press PLUS otsik pöördmutriga

- Lahtivõetav keermesliitmik seinale kinnitatavate liitmike, filtrite ja sulgventiilide ühendamiseks
- Keere vastavalt EN ISO 228-1.

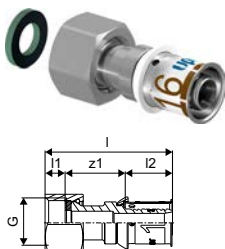

NEW
NEW
NEW
NEW
NEW
NEW
NEW
NEW
NEW
NEW

Art. nr.	Dimension	l	l1	l2	G	z	2. pak.	pakend	UOM
		mm	mm	mm	„	mm			
1070602	16-G1/2"SN	53	8	20	1/2	25	30	1	tk
1070603	16-G3/4"SN	44	8	20	3/4	17	20	1	tk
1070604	20-G1/2"SN	59	8	21	1/2	30	20	1	tk
1070605	20-G3/4"SN	46	8	21	3/4	17	20	1	tk
1070606	25-G3/4"SN	64	8	28	3/4	28	15	1	tk
1070607	25-G1"SN	57	9	28	1	20	15	1	tk
1070608	25-G1 1/4"SN	60	10	28	1 1/4	22	10	1	tk
1070609	32-G1"SN	65	8	28	1	29	10	1	tk
1070610	32-G1 1/4"SN	59	9	28	1 1/4	22	10	1	tk

Uponor S-Press PLUS

Uponor S-Press PLUS põlv pöördmutriga

- Lahtivõetav keermesliitmik seinale kinnitatavate liitmike, filtrite ja sulgventiilide ühendamiseks
- Keere vastavalt EN ISO 228-1.



Art. nr.	Dimension	l1 mm	l2 mm	G "	z1 mm	z2 mm	2. pak.	pakend	UOM
1070612	16-G1/2"SN	41	37	1/2	33	17	20	1	tk
1070613	20-G1/2"SN	46	41	1/2	39	19	20	1	tk
1070614	25-G3/4"SN	39	48	3/4	39	19	10	1	tk

Uponor S-Press PLUS kraanipõlv

- paigaldamiseks seinale või fiksaatorite abil Uponor Smart Aqua paigaldusplaadile.



Art. nr.	Dimension	l1 mm	l2 mm	l3 mm	Rp "	z1 mm	z2 mm	k mm	2. pak.	pakend	UOM
1070639	16-Rp1/2"FT	41	20	20	1/2	21	5	40	40	10	tk
1070640	20-Rp1/2"FT	44	20	21	1/2	23	6	40	40	10	tk
1070641	20-Rp3/4"FT	45	20	23	3/4	24	7	40	20	5	tk
1070642	25-Rp3/4"FT	54	27	25	3/4	26	8	40	20	5	tk

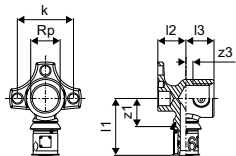

Uponor S-Press PLUS kraanipõlv pikk

- paigaldamiseks seinale või fiksaatorite abil Uponor Smart Aqua paigaldusplaadile.



Art. nr.	Dimension	l1 mm	l2 mm	l3 mm	Rp "	z1 mm	z2 mm	k mm	2. pak.	pakend	UOM
1070644	16-Rp1/2"FT	42	20	30	1/2	22	15	40	40	10	tk
1070645	20-Rp1/2"FT	46	20	30	1/2	25	15	40	40	10	tk

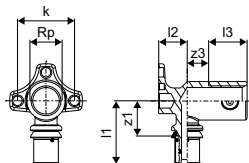

Uponor S-Press PLUS

Uponor S-Press PLUS kattega kraanipölv

- seinapealseks paigalduseks. Ventili ja kattega



NEW

Art. nr.	Dimension	l	l1	l2	Rp2	R2	z1	z2	2. pak.	pakend	UOM
		mm	mm	mm	mm	mm	mm	mm			
1070643	16-Rp3/4"FT	47	31	47	1/2"	3/4"	22	27	20	1	tk

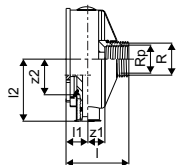

Uponor S-Press PLUS U-kraanipölv

- paigaldamiseks seinale või fiksaatorite abil Uponor Smart Aqua paigaldusplaadile.



NEW

NEW

NEW

NEW

NEW

NEW

NEW

Art. nr.	Dimension	l1	l2	l3	l4	Rp	z1	z2	z3	b	k	2. pak.	pakend	UOM
		mm	mm	mm	mm	mm	mm	mm	mm	mm	mm			
1070629	16-Rp1/2"FT-16	56	56	20	23	1/2	36	36	8	45	40	20	5	tk
1070630	20-Rp1/2"FT-20	57	57	20	23	1/2	36	36	8	45	40		5	tk
1070631	20-Rp1/2"FT-16	57	56	20	23	1/2	36	36	8	45	40		5	tk
1070632	16-Rp1/2"FT-20	56	57	20	23	1/2	36	36	8	45	40		5	tk
1070633	25-Rp1/2"FT-25	64	64	27	24	1/2	36	36	9	60	40		3	tk
1070634	25-Rp1/2"FT-20	64	57	27	24	1/2	36	36	9	60	40		3	tk
1070635	20-Rp1/2"FT-25	57	64	27	24	1/2	36	36	9	60	40		3	tk

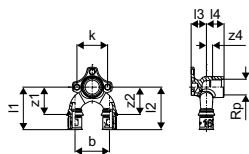

Uponor S-Press PLUS U-segisti kraanipölv

- seinasiseste segistite või loputuskastide ühendamiseks järjestikusel- või ringpaigaldusel.



NEW

NEW

Art. nr.	Dimension	l1	l2	R	z1	z2	b	pakend	UOM
		mm	mm	mm	mm	mm	mm		
1070636	16-16-R1/2"MT	57	60	1/2	42	40	45	5	tk
1070637	20-20-R3/4"MT	61	62	3/4	42	40	45	5	tk

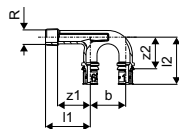

Uponor S-Press PLUS

Uponor S-Press PLUS kork



Art. nr.	Dimension	l mm	l1 mm	l2 mm	2. pak.	pakend	UOM
1070621	16	27	7	20	160	20	tk
1070622	20	28	7	21		10	tk
1070623	25	35	7	28		10	tk
1070624	32	35	7	28		5	tk

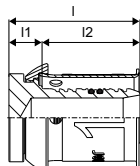

Uponor MLC survestusotsik

- Taaskasutatav otsik Uponor komposiitorude surveprooviks, kruvitakse faasitud toru sisse
- Peale surveproovi lõppu keerake otsik torust välja ja lõigake toru pikkus sobivaks (otsiku pikkus + 1,5 mm).



Art. nr.	Dimension	l mm	l1 mm	l2 mm	G "	z mm	pakend	UOM
1013756	16	52	14	30	1/2	8	10	tk
1013760	20	52	14	30	1/2	8	10	tk
1013762	25	57	14	35	1/2	8	10	tk
1013764	32	64	14	42	1/2	8	5	tk
1013765	40	67	14	45	1/2	8	2	tk

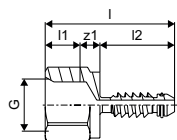

Uponor S-Press PLUS kraanipõlve komplekt



Art. nr.	Dimension	l mm	Rp "	b mm	h mm	h1 mm	k mm	2. pak.	pakend	UOM
1070666	16-Rp1/2"FT c/c150mm	390	1/2	266	54	46	150	175	5	tk

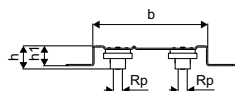
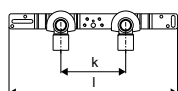

Uponor S-Press PLUS kraanipõlve komplekt



Art. nr.	Dimension	l mm	Rp "	b mm	h mm	h1 mm	k mm	pakend	UOM	
1070661	16-Rp1/2"FT c/c80mm	320	1/2	196	49	46	80	5	tk	
1070662	16-Rp1/2"FT c/c150mm	390	1/2	266	49	46	150	175	5	tk

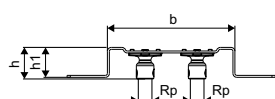
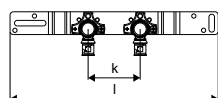

Uponor S-Press PLUS

Uponor S-Press PLUS ühenduspölv

- Tinatatud messing
- vasktoruga 15 x 1 mm, pinnakattega.
- Vasktoru 15 x 1 mm ühendamiseks radiaatoriga kasutada Uponor surveliitmikku Cu (Art. Nr. 1013830).

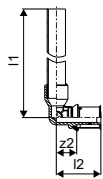

NEW

Art. nr.	Dimension	l1 mm	l2 mm	z mm	pakend	UOM
1070651	16-12CU l=150mm	166	37	17	20	tk

Uponor S-Press siirdmik sulventiiliga vasktorule. DR messing

- Tinatatud DR-messing
- Pressitav ilma kalibreerimiseta
- Värvkood
- Lekkeindikatsioon
- Komplektis kuulkraan
- Surveliidmik CU 10.



NEW

Art. nr.	Dimension	d mm	AG "	pakend	UOM
1007510	16-10CU	16	3/8	10	tk

Uponor S-Press PLUS seinä läbiv otsik

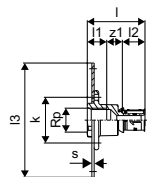

NEW

Art. nr.	Dimension	l mm	l1 mm	l2 mm	l3 mm	s mm	Rp "	z mm	k mm	2. pak.	pakend	UOM
1070652	16-G1/2"FT	51	17	20	100	2,0	1/2	14	40	5	1	tk

Uponor S-Press PLUS

Uponor Smart Aqua kraanipõlve paigaldusplaat

- Galvaniseeritud teras.
- Uponor Smart Aqua kraanipõlvede paigaldamiseks
- Positsioneerimine vastavalt eeltöödeldud avadele
- Komplektis plasttihvtid ja kruvid vastavalt DIN 965
- Kinnitusavad täpseks paigalduseks

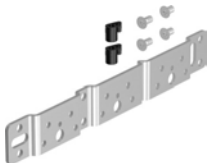

NEW

Art. nr.	Dimension	l mm	s mm	h mm	k mm	k1 mm	w mm	2. pak.	pakend	UOM
1057840	75/150mm	265	3,0	9	75	150	35	5	1	tk

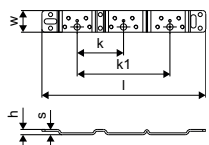

Uponor Smart Aqua kraanipõlve paigaldusplaat

- Galvaniseeritud teras.
- Uponor Smart Aqua kraanipõlvede paigaldamiseks
- Positsioneerimine vastavalt eeltöödeldud avadele
- Komplektis plasttihvtid ja kruvid vastavalt DIN 965
- Kinnitusavad täpseks paigalduseks

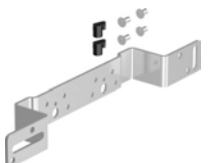

NEW

Art. nr.	Dimension	l mm	s mm	b mm	h mm	k mm	k1 mm	w mm	2. pak.	pakend	UOM
1057842	75/150mm	390	3	266	46	75	150	35	165	5	tk

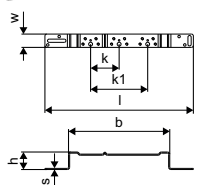

Uponor Smart Aqua kraanipõlve paigaldusnurk

- Galvaniseeritud teras.
- Uponor Smart Aqua kraanipõlvede paigaldamiseks
- Positsioneerimine vastavalt eeltöödeldud avadele
- Komplektis plasttihvtid ja kruvid vastavalt DIN 965
- Kinnitusavad täpseks paigalduseks



NEW

Art. nr.	l mm	b mm	h mm	2. pak.	pakend	UOM
1057843	144	82	46	5	1	tk

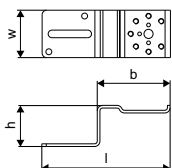

Uponor S-Press PLUS

Uponor Smart Aqua kraanipõlve paigalduslatt 2m

- Galvaniseeritud teras.
- Uponor Smart Aqua kraanipõlvede paigaldamiseks
- Positsioneerimine vastavalt eeltöödeldud avadele
- Komplektis plastihvtid ja kruvid vastavalt DIN 965
- Kinnitusavad täpseks paigalduseks

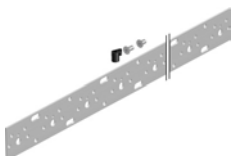

NEW

Art. nr.	Dimension	l mm	k mm	2. pak.	pakend	UOM
1057844	2m	2000	75	10	1	tk

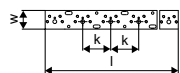

Uponor S-Press PLUS siirdmik

- Joodetud vasktoruga vastavalt EN 1057 (poolkõva / R250)
- üleni tinatatud
- Tähelepanu:
vasktoru ots ainult pressliitmikele või sobivatele surveliitmikele.

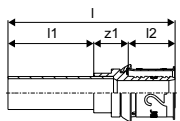

NEW

NEW

NEW

NEW

NEW

NEW

NEW

NEW

NEW

Art. nr.	Dimension	l mm	l1 mm	l2 mm	z mm	2. pak.	pakend	UOM
1070705	16-10CU	66	30	20	16	80	10	tk
1070706	16-12CU	66	30	20	16	80	10	tk
1070615	16-15CU	76	40	20	16	160	20	tk
1070707	20-15CU	76	39	21	16		10	tk
1070616	20-18CU	78	40	21	17	40	10	tk
1070617	20-22CU	81	41	21	19	60	15	tk
1070618	25-22CU	88	41	28	19	20	5	tk
1070619	25-28CU	92	43	28	21		5	tk
1070620	32-28CU	92	43	28	21	20	5	tk

Uponor S-Press PLUS radiatori ühenduspõlv pinnakattega

- pinnakattega messing
- vasktoru 15 x 1 mm, pinnakattega.
- Vasktoru 15 x 1 mm ühendamiseks radiatoriga kasutada Uponor vase surveliitmikku (art.nr. 1013830).

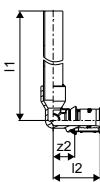

NEW

NEW

Art. nr.	Dimension	l1 mm	l2 mm	z mm	pakend	UOM
1070678	16-15CU l=350mm	366	37	17	20	tk
1070680	25-22CU l=250mm	250	48	19	640	20 tk

Uponor S-Press PLUS

Uponor S-Press PLUS radiaatori ühenduskolmik pinnakattega

- Tinatatud messing
- Painutatud vasktoru 15 x 1 mm, pinnakattega
- Vasktoru 15 x 1 mm ühendamiseks radiaatoriga kasutada Uponor vase surveliitmikku (art.nr. 1013830)

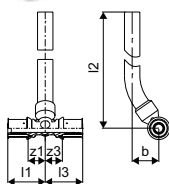

Art. nr.	Dimension	l1 mm	l2 mm	l3 mm	z1 mm	z2 mm	z3 mm	b mm	2. pak.	pakend	UOM
1070681	16-15CU-16 l=350mm	38	351	38	18	18	18	26	600	20	tk
1070682	20-15CU-20 l=350mm	40	353	40	19	19	19	27	600	20	tk

Uponor Smart Radi katteplaat valge



Art. nr.	Dimension	d mm	l mm	l1 mm	l2 mm	2. pak.	pakend	UOM
1011370	16 white	16	47	15		50	50	tk
1011372*	20 white	20	48	14		50	50	tk

Uponor Smart Radi kaksik katteplaat

- Polüpropüleen, valge
- Uponor Uni Pipe PLUS ja MLC torude 14 - 20 mm põranda või seinä läbiviikude katmiseks radiaatorküttesüsteemis
- Toru telgede vahe 50 mm
- Kaheosaline, ühendatakse kahe lukusti abil
- Tulepüsivuse klass B2 vast. EN 13501-1.

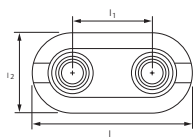

Art. nr.	Dimension	d mm	l mm	l1 mm	l2 mm	2. pak.	pakend	UOM
1011373	14-20 white double	14-20	100	50	50	500	50	tk

Uponor RS

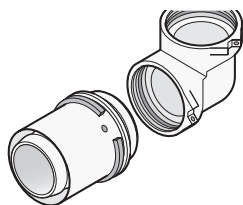

Uponor RS on unikaalne moodulsüsteem püstakute ja magistraalitorustike ehitamiseks. 40 komponendist süsteem võimaldab koostada sadu erinevaid variatsioone.

Eelised

- Unikaalne ühendus korpuse ja adapterite vahel
- Kiire ja paindlik: tööriistavaba ühendus, palju variante
- Muutmise võimalus paigalduse käigus
- Värvkoodid läbimõõtuudel 16 -110mm



Kirjeldus

- fikseeritud presshülsiga
- stoppervõru
- värvkood
- lekkeindikaator

Kasutusala

- Tarbevesi: püsiv töötemperatuur 0°C kuni 70°C maksimaalsel püsival tööõhul 10 bar. Lühiajaline avariitemperatuur 95°C 100 tundi kasutusaja jooksul.
- Küte: püsiv töötemperatuur kuni 80°C maksimaalsel püsival tööõhul 10 bar. Lühiajaline avariitemperatuur 100°C 100 tundi kasutusaja jooksul.
- Kui ei ole teisiti nimetatud: välis- ja sisekeermed vast. EN 10226-1.

Sertifitseerimine

- DVGW
- AENOR

Uponor RS jätk

- Tinatatud messing
- Baasdetail kõikidele RS2 või RS3 siirdmikele, komplektis 2 lukustit.



Art. nr.	Dimension	l mm	pakend	UOM
1029144	RS2-RS2	58	1	tk
1029145	RS3-RS3	58	1	tk

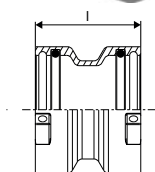

Uponor RS põlv

- Tinatatud messing
- Baasdetail kõikidele RS2 või RS3 siirdmikele, komplektis 2 lukustit.



Art. nr.	Dimension	l1 mm	l2 mm	pakend	UOM
1029138	RS2-RS2	51	51	1	tk
1029139	RS3-RS3	68	68	1	tk

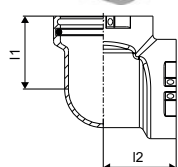

Uponor RS

Uponor RS põlv 45°

- Tinatatud messing
- Baasdetail kõikidele RS2 või RS3 siirdmikele, komplektis 2 lukustit.

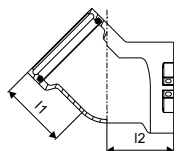

Art. nr.	Dimension	l1 mm	l2 mm	pakend	UOM
1029140	RS2-RS2	51	51	1	tk
1029141	RS3-RS3	68	68	1	tk

Uponor RS kolmik

- Tinatatud messing
- Baasdetail kõikidele RS2 või RS3 siirdmikele, komplektis 3 lukustit.

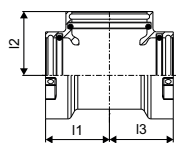

Art. nr.	Dimension	l1 mm	l2 mm	l3 mm	pakend	UOM
1029142	RS2-RS2-RS2	51	51	51	1	tk
1029143	RS3-RS3-RS3	68	68	68	1	tk

Uponor RS üleminek

- Tinatatud messing
- Baasdetail kõikidele RS2 või RS3 siirdmikele, komplektis 1 lukusti.

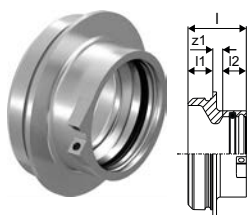

Art. nr.	Dimension	l mm	l1 mm	l2 mm	z1 mm	pakend	UOM
1029146	RS3-RS2	47	20	19	8	1	tk

Uponor RS vahetükk

- Tinatatud messing
- Vahetükk samas mõõdus RS baasdetailide ühendamiseks.

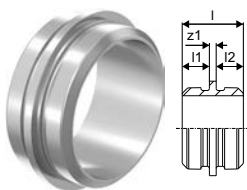

Art. nr.	Dimension	l mm	l1 mm	l2 mm	z1 mm	pakend	UOM
1046750	RS2-RS2 l=5mm	45	20	20	5	1	tk
1046751*	RS3-RS3 l=5mm	45	20	20	5	1	tk

Uponor RS

Uponor RS vahetükk

- Tinatatud messing
- Vahetükk samas moodsus RS baasdetailide ühendamiseks, näiteks kolmikute kollektorite koostamiseks või jaotustorustikest üleminekutes.

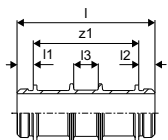

Art. nr.	Dimension	l mm	l1 mm	l2 mm	l3 mm	z mm	pakend	UOM
1046477*	RS2-RS2 l=130mm	170	20	20	30	130	1	tk
1046478*	RS3-RS3 l=210mm	250	20	20	30	210	1	tk

Uponor RS siirdmik S-Press

- Tinatatud messing
- Ühildub kõikide RS2 baasdetailidega.

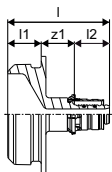

Art. nr.	Dimension	l mm	l1 mm	l2 mm	z mm	pakend	UOM
1059397	16-RS2	61	20	21	20	1	tk
1059396	20-RS2	62	20	22	20	1	tk
1029121	25-RS2	59	20	30	9	1	tk
1029122	32-RS2	59	20	30	9	1	tk

Uponor RS S-Press PLUS



Art. nr.	Dimension	l mm	l1 mm	l2 mm	z mm	pakend	UOM
1095818	20-RS2	NaN	NaN	NaN	NaN	1	tk
1095819	25-RS2	75	20	28	27	1	tk
1095820	32-RS2	75	20	28	27	1	tk

Uponor RS siirdmik S-Press

- Tinatatud messing
- Ühildub kõikide RS2 ja RS3 baasdetailidega.

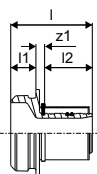
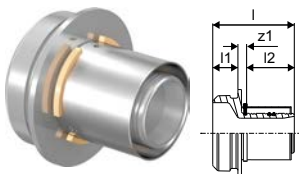

Art. nr.	Dimension	l mm	l1 mm	l2 mm	z mm	pakend	UOM
1046940	40-RS2	65	20	38	7	1	tk
1046941	50-RS2	65	20	38	7	1	tk
1029125	63-RS2	88	20	61	7	1	tk
1029126	75-RS2	88	20	61	7	1	tk
1029127	90-RS3	93	20	62	11	1	tk
1029128	110-RS3	93	20	62	11	1	tk

Uponor RS

Uponor RS otsik väliskeere

- Tinatatud messing
- Ühildub kõikide RS2 ja RS3 baasdetailidega.

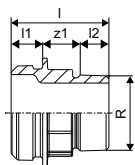

Art. nr.	Dimension	l mm	l1 mm	l2 mm	R "	z1 mm	pakend	UOM
1059402	R1 1/2"MT-RS2	62	20	24	1 1/2	18	1	tk
1029131	R2"MT-RS2	66	20	23	2	23	1	tk
1029132	R2 1/2"MT-RS2	63	20	27	2 1/2	16	1	tk
1029133	R3"MT-RS3	73	20	30	3	23	1	tk

Uponor RS otsik sisekeere

- Tinatatud messing
- Ühildub kõikide RS2 ja RS3 baasdetailidega.

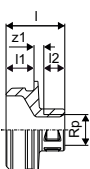

Art. nr.	Dimension	l mm	l1 mm	l2 mm	Rp "	z1 mm	pakend	UOM
1059403	Rp1/2"FT-RS2	42	20	15	1/2	7	1	tk
1029134	Rp1"FT-RS2	45	20	19	1	6	1	tk
1029135	Rp2"FT-RS2	54	20	26	2	8	1	tk
1029136	Rp2 1/2"FT-RS2	63	20	30	2 1/2	12	1	tk
1059404	Rp1/2"FT-RS3	43	20	15	1/2	8	1	tk
1029137	Rp3"FT-RS3	65	20	33	3	12	1	tk

Uponor RS äärrik

- Tinatatud messing
- Ühildub kõikide RS2 või RS3 baasdetailidega
- Äärrik PN6/PN16 vast. EN 1092-3
- 4/8 kinnituspoltide ava.

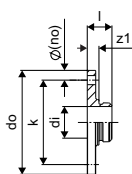

Art. nr.	Dimension	l mm	l3 mm	di mm	do mm	z1 mm	k mm	p bar	pakend	UOM
1059398	RS2-DN65 (PN6)	38	18	48,7	160	18	130	6	1	tk
1059399*	RS2-DN65 (PN16)	45	25	48,7	185	25	145	16	1	tk
1059400	RS3-DN80 (PN6)	38	18	78,1	190	18	150	6	1	tk
1029129*	RS3-DN80 (PN16)	45		78,1	200	25	160	16	1	tk
1059401	RS3-DN100 (PN6)	41	21	78,1	210	21	170	6	1	tk
1029130	RS3-DN100 (PN16)	44		78,1	220	24	180	16	1	tk

Uponor RS lukusti

- plastik
- RS siirdmike lukustamiseks RS baasdetailide külge.



Art. nr.	Dimension	värvus	pakend	UOM
1042921	RS2 black	must	10	tk
1042922	RS3 grey	Hall (RAL 7015)	10	tk

Uponor Uni-X

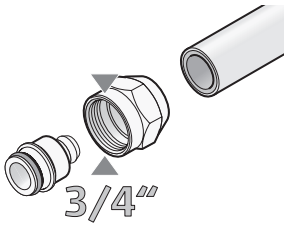

UNI-X roostevaba kollektor ja lai valik 3/4" eurokoonus ja muid tollmõõdus surveliitmike radiaatorküttele.

Eelised

- Universaalne kollektor
- Universaalsed surveliitmikud
- Lihtne sobitada muude torusüsteemidega



Kasutusala

- Küttevee jaotamiseks radiaatorküttesüsteemides

Uponor Uni-X kollektor H 1S N

- Roostevabast terasest kollektor radiaatorküttele
- Pöördmutterühendus 1" sisekeere, komplektis lametihend
- Väljuvate otste samm 50 mm
- Kollektorite telgede vahe 200 mm

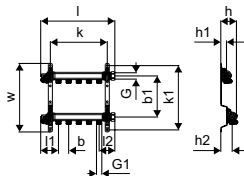

Art. nr.	Dimension	l	l1	l2	G	G1	b	b1	b2	h	h1	h2	k	k1	w	väljundid p	2. pak.	pakend	UOM	
		mm	mm	mm	"	"	mm	mm	mm	mm	mm	mm	mm	mm	mm	-	bar			
1088873	2xG3/4 Euro	210	87	73	1	3/4	50	215	215	75	30	50	135	336	357	2	6		tk	
1088874	3xG3/4 EURO	260	87	73	1	3/4	50	215	215	75	30	50	185	336	357	3	6		tk	
1088875	4xG3/4 EURO	310	87	73	1	3/4	50	215	215	75	30	50	235	336	357	4	6		tk	
1088876	5xG3/4 EURO	360	87	73	1	3/4	50	215	215	75	30	50	285	336	357	5	6		tk	
1088877	6xG3/4 EURO	410	87	73	1	3/4	50	215	215	75	30	50	335	336	357	6	6		tk	
1088878	7xG3/4 EURO	460	87	73	1	3/4	50	215	215	75	30	50	385	336	357	7	6		tk	
1088879	8xG3/4 EURO	510	87	73	1	3/4	50	215	215	75	30	50	435	336	357	8	6		tk	
1088880	9xG3/4 EURO	560	87	73	1	3/4	50	215	215	75	30	50	485	336	357	9	6		tk	
1088881	10xG3/4 EURO	610	87	73	1	3/4	50	215	215	75	30	50	535	336	357	10	6	48	1	tk
1088882	11xG3/4 EURO	660	87	73	1	3/4	50	215	215	75	30	50	585	336	357	11	6	48	1	tk
1088883	12xG3/4 EURO	710	87	73	1	3/4	50	215	215	75	30	50	635	336	357	12	6	48	1	tk

Uponor Uni-X

Uponor Uni-X surveliitmik MLC

- Messingist surveliitmik
- Uponor Uni Pipe PLUS ja MLC torude ühendamiseks kollektoriga Uni X
- Sisekeere 3/4" eurokoonus, vast. EN ISO 228-1.

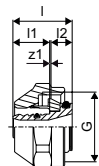

Art. nr.	Dimension	l	l1	G	z	2. pak.	pakend	UOM
		mm	mm	"	mm			
1058090	16-3/4"FT Euro	23	13	3/4	3	25	1	tk
1058092	20-3/4"FT Euro	24	14	3/4	3	25	1	tk
1058093	25-3/4"FT Euro	27	14	3/4	7	25	1	tk

Uponor Uni-X nippel pinnakattega

- Tinatatud messing
- Väliskeere vast. to EN ISO 228-1.

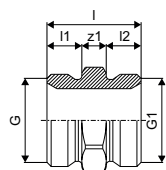

Art. nr.	Dimension	l	l1	l2	G	G1	z	2. pak.	pakend	UOM
		mm	mm	mm	"	"	mm			
1006641	G3/4"MT Euro-G3/4"MT Euro	27	10	10	3/4	3/4	7	80	10	tk

Uponor Uni-C

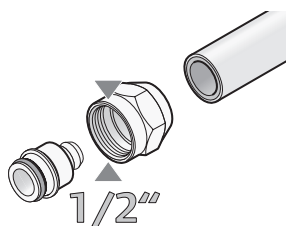

Messingkollektor koos laia valiku 1/2" keermega surveliitmikega

Eelised

- Messingkollektor
- Messingist surveliitmikud
- Lihtne sobitada muude torusüsteemidega
- Paindlik süsteem



Uponor Uni-C kollektor S

- Tinatatud messing
- Otsad 1" VK/SK. Väljundid 1/2" VK Ühendamiseks Uponor surveliitmikega.

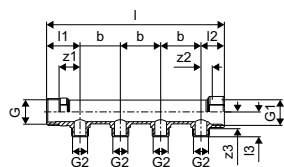

Art. nr.	Dimension	l	l1	l2	l3	G	G1	G2	z1	z2	z3	b	väljundid	pakend	UOM
		mm	mm	mm	mm	"	"	"	mm	mm	mm	mm	-		
1014107*	1"MT/FT 2X1/2"MT	121	42	29	31	1	1	1/2	26	14	21	50	2	1	tk
1014111*	1"MT/FT 3X1/2"MT	171	42	29	31	1	1	1/2	26	14	21	50	3	1	tk
1014109*	1"MT/FT 4X1/2"MT	220	42	29	31	1	1	1/2	26	14	21	50	4	1	tk

Uponor Uni-C kollektori otsakork S/SH PL

- Pinnakattega messing
- Komplektis tihend

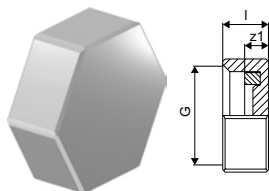

Art. nr.	Dimension	l	G	z1	2. pak.	pakend	UOM
		mm	"	mm			
1014121*	G1"FT	12	1	4	120	20	tk

Uponor Uni-C surveliitmik MLC

- Messing surveliitmik
- Uponor Uni Pipe PLUS ja MLC torude ühendamiseks kollektoritega (näit. Uponor kollektor S, SH)
- Sisekeere 1/2" vastavalt EN ISO 228-1
- Ei vaja toru faasimist.

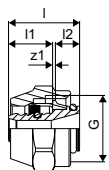

Art. nr.	Dimension	l	l1	G	z1	2. pak.	pakend	UOM
		mm	mm	"	mm			
1058086	16-1/2"FT	23	13	1/2	4	25	1	tk
1058088	20-1/2"FT	26	14	1/2	7	25	1	tk

Uponor Uni-C

Uponor Uni-C nippel pinnakattega MLC

- Tinatatud messing
- Väliskeere vast. EN ISO 228-1.

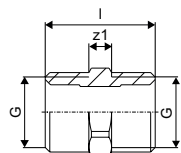

Art. nr.	Dimension	l	G	G1	z	2. pak.	pakend	UOM
		mm	"	"	mm			
1013894	1/2"MT-1/2"MT	29	1/2	1/2	6	160	20	tk

Uponor Uni-C põlv pinnakattega MLC

- Tinatatud messing
- Väliskeere vast. EN ISO 228-2.

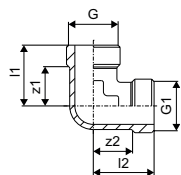

Art. nr.	Dimension	l1	l2	G	G1	z	z	2. pak.	pakend	UOM
		mm	mm	"	"	mm	mm			
1013914	G1/2"MT-G1/2"MT	29	29	1/2	1/2	18	18	80	10	tk

Uponor Aqua Pipe

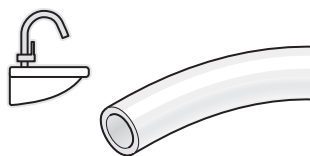

Uponor Aqua Pipe on valmistatud kõrgeima kvaliteediga ristseotud polüetüleenist kasutamiseks tarbevesüsteemides

Eelised

- Sertifitseeritud kvaliteet
- Korrosioonikindel
- Soojuslik mälu
- Kerge ja väga elastne
- Vastupidav



Kirjeldus

- Torud: peroksiidmeetodil ristseotud polüetüleen (PE-Xa), vast. EN ISO 15875
- 5-kihiline
- Kasutusklass 2 - soe tarbevesi
- Tuleklass E vastvalt DIN EN 13501-1.

Kasutusala

- Tarbevesi: püsiv töötemperatuur 0°C kuni 70°C maksimaalsel püsival tööühul 10 bar. Lühiajaline avariitemperatuur 95°C 100 tundi kasutusaja jooksul.

Uponor Aqua Pipe toru PN6

- Töörõhk 6 bar
- Rull

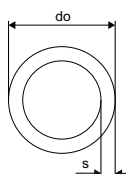

Art. nr.	Dimension	L m	do mm	s mm	p bar	värvus -	uPoints	2. pak.	pakend	UOM
1048757	32x2,9 50m	50	32	2,9	6	nat.	400	550	50	m

Uponor Aqua Pipe toru PN10

- Töörõhk 10 bar
- Rull

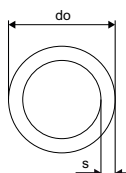

Art. nr.	Dimension	L m	do mm	s mm	p bar	värvus -	uPoints	2. pak.	pakend	UOM
1022682	16x2,2 100m	100	16	2,2	10	nat.	200	1100	100	m
1001201	20x2,8 50m	50	20	2,8	10	nat.	200	550	50	m
1001202	25x3,5 50m	50	25	3,5	10	nat.	300	400	50	m
1001203	32x4,4 50m	50	32	4,4	10	nat.	400	350	50	m

Uponor Radi Pipe



Uponor Radi Pipe on valmistatud kõrgeima kvaliteediga ristseotud polüetüleenist ja on mõeldud kasutamiseks kütte- ning jahutussüsteemides

Eelised

- Sertifitseeritud kvaliteet
- Soojuslik mälu
- Kerge, elastne
- Vastupidav
- Hapniku difusioonikindel



Kirjeldus

- Torud: peroksiidmeetodil ristseotud polüetüleen (PE-Xa), vast. EN ISO 15875
- 5-kihiline
- EVOH (etüül vinüül alkohol) kiht hapniku difusiooni takistamiseks vast. DIN 4726
- Kasutusklass 5 - kõrgetemperatuuriline radiaatorküte
- Tuleklass E vastavalt DIN EN 13501-1.

Kasutusala

- Küte: püsiv töötemperatuur kuni 90°C. Lühiajaline avariitemperatuur 100°C kuni 100 tundi kasutusaja jooksul.

Uponor Radi Pipe toru PN6

- Töörõhk 6 bar
- Rull

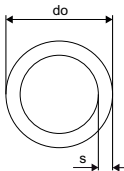

Art. nr.	Dimension	L m	do mm	s mm	p bar	värvus	uPoints	2. pak.	pakend	UOM
1047610	16x2,0	120m	120	16	2,0	6	nat.	200	960	120 m
1022518	20x2,0	120m	120	20	2,0	6	nat.	300	840	120 m
1022689	25x2,3	50m	50	25	2,3	6	nat.	200	450	50 m
1001220	32x2,9	50m	50	32	2,9	6	nat.	300	550	50 m
1008979	40x3,7	50m	50	40	3,7	6	nat.	950	350	50 m
1008980	50x4,6	50m	50	50	4,6	6	nat.	1500	350	50 m
1008981	63X5,8	50m	50	63	5,8	6	nat.	2550		50 m

Uponor Combi Pipe

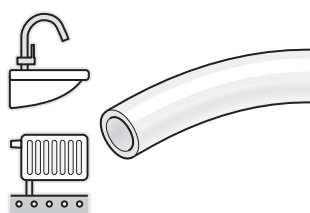

Uponor Combi Pipe ühendab endas Uponor Aqua Pipe ja Uponor Radi Pipe omadusi ning on mõeldud kasutamiseks tarbevee-, kütte- ja jahutussüsteemides

Eelised

- Sertifitseeritud kvaliteet
- Hapniku difusioonikindel
- Termilise mäluga
- Kerge ja elastne
- Kauakestev



Uponor Combi Pipe kaitse hülsis

Kirjeldus

- Torud: Ristseotud polüetüleen (PE-Xa), vast. EN ISO 15875
- EVOH (etüül vinüül alkohol) kiht hapniku difusiooni takistamiseks vast. DIN 4726
- Kasutusklass 2 - soe tarbevesi
- Kasutusklass 4 - põrandaküte ja madalatemperatuuriline radiaatorküte
- Kasutusklass 5 - kõrgetemperatuuriline radiaatorküte
- Tuleklass E vastavalt DIN EN 13501-1
- Hülsstoru: kõrgtihe polüetüleen

Kasutusala

- Tarbevesi: püsiv töötemperatuur 0°C kuni 70°C maksimaalsel püsival töö rõhul 10 bar. Lühiajaline avariitemperatuur 95°C kuni 100 tundi kasutusea jooksul.
- Küte: püsiv töötemperatuur kuni 90°C maksimaalsel püsival töö rõhul 6 bar. Lühiajaline avariitemperatuur 100°C kuni 100 tundi kasutusea jooksul.
- Lekkekindel paigaldus. Vigastuse korral sisemise toru vahetamise võimalus

Uponor Combi Pipe hülsis valge

- Töö rõhk 10 bar
- Rull

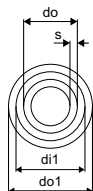
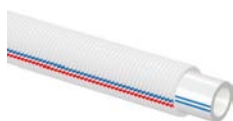

Art. nr.	Dimension	L m	di1 mm	do mm	do1 mm	s mm	p bar	värvus	uPoints	2. pak.	pakend	UOM
1087905	16x2,0 25/20 50m	50	20	16	25	2,0	10	valge	350	550	50	m
1047829	20x2,8 28/23 50m	50	23	20	28	2,8	10	valge	500	350	50	m

Uponor Teck

Gofreeritud hülstoru torude kaitseks tarbevee-, kütte- ja jahutussüsteemides

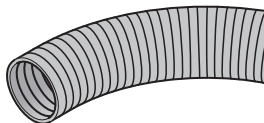

Eelised

- Tagab ohutu paigalduse
- Sertifitseeritud kvaliteet
- Kaitseb voolutoru
- Erinevad värvid soojale ja külmale veele



Kirjeldus

- Gofreeritud, kõrgtihen polüetüleen (HDPE)
- Tuleklass E vastavalt EN 13501-1
- Rullides.

Kasutusala

- Kasutatakse toru-torus paigaldusel lekkeriskide vähendamiseks. Võimaldab vajadusel sisetoru väljavahetamist

Uponor Teck hülstoru punane

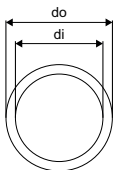

Art. nr.	Dimension	L m	di mm	do mm	värvus -	2. pak.	pakend	UOM
1012858	25/20 red 50m	50	20	25	punane	2500	50	m
1012862	28/23 red 50m	50	23	28	punane	2000	50	m

Uponor Teck hülstoru sinine

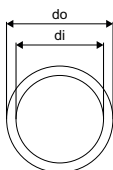

Art. nr.	Dimension	L m	di mm	do mm	värvus -	2. pak.	pakend	UOM
1012859	25/20 blue 50m	50	20	25	sinine	2500	50	m
1012863	28/23 blue 50m	50	23	28	sinine	2000	50	m

Uponor Teck hülstoru must

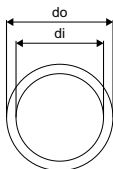

Art. nr.	Dimension	L m	di mm	do mm	värvus -	2. pak.	pakend	UOM
1012860	25/20 black 50m	50	20	25	must	2500	50	m
1012864	28/23 black 50m	50	23	28	must	2000	50	m
1012869	35/29 black 50m	50	29	35	must	1400	50	m
1012872	43/36 black 25m	25	36	43	must	600	25	m
1023127	54/48 black 25m	25	48	54	must	600	25	m

Uponor Q&E

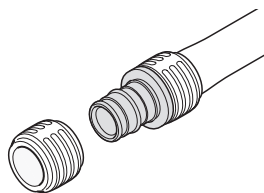

Uponor Q&E on unikaalne ühendussüsteem, kus kasutatakse ristseotud polüetüleenist PE-Xa torude kokkutõmbumisvõimet. Lai liitmike ja tarvikute valik võimaldab kiire ja lihtsa paigalduse.

Eelised

- PEX-a toru ja liitmiku ideaalne liide
- Korrosioonikindel paigaldus
- Väikese rõhukaoga liitmikud
- Ergonoomilise kujuga rõngas



Kirjeldus

Q&E liitmikud ja rõngad Uponor Pex torudele. Metallliitmikud kõrgekvaliteedilise messingist. PPSU plastliitmikud. Q&E rõngad ei ole liitmikega komplektis.

Kasutusala

- Liitmikud PE-Xa torule
- Liitmikud sobivad ka ECOFLEX süsteemis kasutamiseks
- Keermesliitmike välis- ja sisekeermed vastavalt EN 10226-1.

Uponor Q&E evolution rõngas valge

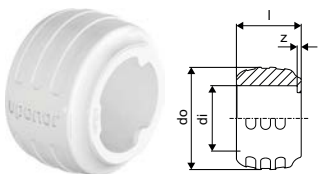

Art. nr.	Dimension	l mm	di mm	do mm	z mm	p bar	värvus -	2. pak.	pakend	UOM
1057453	16	16	16,2	25,3	1	6+10	valge	900	20	tk
1057454	20	20	20,2	29,2	1	6+10	valge	520	20	tk
1057455	25	25	25,3	34,6	1	6+10	valge	300	20	tk
1057456	32	32	32,4	41,8	1	6+10	valge	150	10	tk

Uponor Q&E evolution rõngas punane

- Koonilise välispinnaga
- Piirajaga
- Polüetüleen

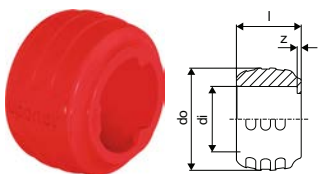

Art. nr.	Dimension	l mm	di mm	do mm	z mm	p bar	värvus -	2. pak.	pakend	UOM
1058010	16	16	16,2	25,3	1	6+10	punane	900	20	tk
1058011	20	20	20,2	29,2	1	6+10	punane	520	20	tk
1058012	25	25	25,3	34,6	1	6+10	punane	300	20	tk

Uponor Q&E evolution rõngas sinine

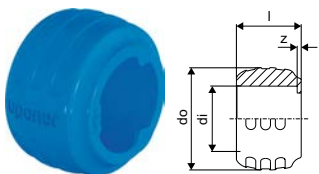

Art. nr.	Dimension	l mm	di mm	do mm	z mm	p bar	värvus -	2. pak.	pakend	UOM
1058013	16	16	16,2	25,3	1	6+10	sinine	900	20	tk
1058014	20	20	20,2	29,2	1	6+10	sinine	520	20	tk
1058015	25	25	25,3	34,6	1	6+10	sinine	300	20	tk

Uponor Q&E

Uponor Q&E rõngas piirajaga naturaalne

- Piirajaga
- PE-X

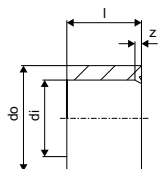

Art. nr.	Dimension	l mm	di mm	do mm	z mm	p bar	värvus -	2. pak.	pakend	UOM
1045464	40	41	40,8	50,2	3	6+10	nat.	80	5	tk
1045489	50	50	51	63	4	6+10	nat.	70	5	tk
1045490	63	63	64,3	75,7	4	6+10	nat.	35	5	tk
1085087	75	76	76,3	88,3	4	6+10	nat.	18	2	tk

Uponor Q&E põlv PPSU

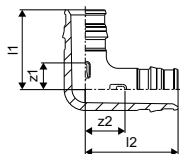

Art. nr.	Dimension	l1 mm	l2 mm	z1 mm	z2 mm	p bar	2. pak.	pakend	UOM
1008679	16-16	27	32	9	13	6+10	100	5	tk
1008680	20-20	34	39	12	16	6+10	40	5	tk
1008681	25-25	42	47	14	19	6+10	25	5	tk
1001245	32-32	53	59	18	23	6+10	15	1	tk
1008683	40-40	65	74	21	29	6+10	10	1	tk
1042859	50-50	83	98	29	44	6+10	5	1	tk
1042858	63-63	100	112	33	44	6+10	3	1	tk
1085080	75-75	149	149	64	65	6+10	2	1	tk

Uponor Q&E jätk PPSU

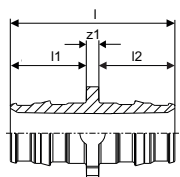

Art. nr.	Dimension	l mm	l1 mm	l2 mm	z1 mm	z2 mm	p bar	2. pak.	pakend	UOM
1008669	16-16	39	18	18	3	3	6+10	100	5	tk
1008932	20-20	47	22	22	3	3	6+10	80	5	tk
1008671	25-25	58	28	28	3	3	6+10	50	5	tk
1001235	32-32	73	35	35	3	3	6+10	20	1	tk
1008673	40-40	90	44	44	3	3	6+10	10	1	tk
1042866	50-50	113	54	54	5	5	6+10	10	1	tk
1042865	63-63	141	68	68	6	6	6+10	5	1	tk
1085084	75-75	179	86	86	7	7	6+10	10	1	tk

Uponor Q&E

Uponor Q&E siirdmik PPSU

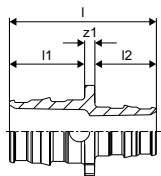

Art. nr.	Dimension	l mm	l1 mm	l2 mm	z mm	p bar	2. pak.	pakend	UOM
1008674	20-16	43	22	18	3	6+10	100	5	tk
1008675	25-16	49	28	18	3	6+10	40	5	tk
1008676	25-20	53	22	28	3	6+10	40	5	tk
1001240	32-25	66	28	35	3	6+10	20	1	tk
1008678	40-32	82	35	44	3	6+10	10	1	tk
1042879	50-32	94	54	35	5	6+10	10	1	tk
1042867	50-40	103	54	44	5	6+10	10	1	tk
1042878	63-40	117	68	44	6	6+10	5	1	tk
1042877	63-50	128	68	54	6	6+10	5	1	tk
1085086	75-50	147	86	54	6	6+10	10	1	tk
1085085	75-63	160	86	68	7	6+10	10	1	tk

Uponor Q&E kolmik PPSU

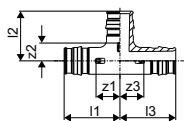

Art. nr.	Dimension	l1 mm	l2 mm	l3 mm	z1 mm	z2 mm	z3 mm	p bar	2. pak.	pakend	UOM
1008684	16-16-16	32	27	32	14	10	14	6+10	70	5	tk
1008685	20-20-20	39	34	39	17	12	17	6+10	35	5	tk
1008686	25-25-25	47	42	47	20	15	20	6+10	25	5	tk
1001250	32-32-32	59	53	59	24	18	24	6+10	10	1	tk
1008688	40-40-40	74	65	74	30	22	30	6+10	5	1	tk
1042861	50-50-50	92	83	92	38	29	38	6+10	3	1	tk
1042860	63-63-63	112	102	112	44	5	44	6+10	2	1	tk
1085081	75-75-75	156	123	156	70	37	70	6+10	2	1	tk

Uponor Q&E

Uponor Q&E erikolmik PPSU

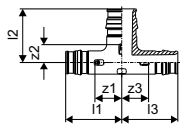

Art. nr.	Dimension	l1 mm	l2 mm	l3 mm	z mm	z mm	z mm	p bar	2. pak.	pakend	UOM
1008710	16-20-16	35	33	35	17	11	17	6+10	40	5	tk
1008700	20-16-16	36	29	32	14	11	14	6+10	40	5	tk
1008689	20-16-20	36	29	36	14	11	14	6+10	40	5	tk
1008697	20-20-16	36	34	32	14	12	14	6+10	40	5	tk
1008711	20-25-20	42	40	42	20	12	20	6+10	25	5	tk
1008702	25-16-16	41	32	32	14	14	14	6+10	25	5	tk
1008699	25-16-20	41	32	36	14	14	14	6+10	25	5	tk
1008690	25-16-25	41	32	41	14	14	14	6+10	25	5	tk
1008701	25-20-16	44	37	35	17	15	17	6+10	25	5	tk
1008703	25-20-20	44	37	39	17	15	17	6+10	25	5	tk
1008691	25-20-25	44	37	44	17	15	17	6+10	25	5	tk
1001420	25-25-20	47	42	42	20	15	20	6+10	25	5	tk
1008712	25-32-25	52	50	52	24	15	24	6+10	15	1	tk
1001422	32-20-25	52	40	44	17	18	17	6+10	15	1	tk
1001424	32-20-32	52	40	52	17	18	17	6+10	15	1	tk
1008704	32-25-20	55	45	42	20	NaN	20	6+10	15	1	tk
1001426	32-25-25	55	45	47	20	18	20	6+10	15	1	tk
1001428	32-25-32	55	45	55	20	18	20	6+10	15	1	tk
1008713	32-40-32	65	61	65	30	18	30	6+10	10	1	tk
1008707	40-20-32	60	44	52	17	22	17	6+10	5	1	tk
1008694	40-20-40	60	44	60	17	22	17	6+10	5	1	tk
1008708	40-25-32	63	49	55	20	22	20	6+10	5	1	tk
1008695	40-25-40	63	49	63	20	22	20	6+10	5	1	tk
1008709	40-32-32	68	57	59	24	22	24	6+10	5	1	tk
1008696	40-32-40	68	57	68	24	22	24	6+10	5	1	tk
1042876	50-25-40	92	57	82	38	29	39	6+10	4	1	tk
1042864	50-25-50	92	57	92	38	29	38	6+10	4	1	tk
1042863	50-32-50	92	64	92	38	29	38	6+10	4	1	tk
1042862	50-40-40	92	73	82	38	29	39	6+10	4	1	tk
1042875	50-40-50	92	73	92	38	29	38	6+10	4	1	tk
1042871	63-25-50	112	62	99	44	35	45	6+10	2	1	tk
1042873	63-25-63	112	60	112	44	33	44	6+10	2	1	tk
1042870	63-32-63	112	70	112	44	35	44	6+10	2	1	tk
1042869	63-40-40	112	78	99	44	35	55	6+10	2	1	tk
1042872	63-40-63	112	78	112	44	35	44	6+10	2	1	tk
1042868	63-50-50	112	89	99	44	35	45	6+10	2	1	tk
1042874	63-50-63	112	89	112	44	35	44	6+10	2	1	tk
1085083	75-25-75	118	67	118	32	39	32	6+10	4	1	tk
1085082	75-40-75	118	83	118	32	83	32	6+10	4	1	tk

Uponor Q&E

Uponor Q&E kollektor PL

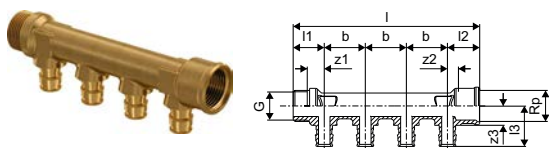

Art. nr.	Dimension	l	l1	l2	l3	G	Rp	z1	z2	b	väljundid	p	2. pak.	pakend	UOM
		mm	mm	mm	mm	"	"	mm	mm	mm	-	bar			
1023027	3/4"MT/FT 2X16 c/c35mm	89	27	28	35	3/4	3/4	15	9	35	2	6+10	20	1	tk
1023028	3/4"MT/FT 3X16 c/c35mm	124	27	28	35	3/4	3/4	15	9	35	3	6+10	15	1	tk
1023029	3/4"MT/FT 4X16 c/c35mm	159	27	28	35	3/4	3/4	15	9	35	4	6+10	10	1	tk

Uponor Q&E kollektor ventiilidega PL SH

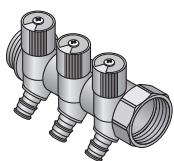

Art. nr.	Dimension	väljundid	d	IG	p	uPoints	2. pak.	pakend	UOM
		-	mm	"	bar				
1048520	1"MT/FT 2X16 c/c38mm	2	16	G 1	6+10	150	32	1	tk
1048521	1"MT/FT 3X16 c/c38mm	3	16	G 1	6+10	200	32	1	tk
1048522	1"MT/FT 4X16 c/c38mm	4	16	G 1	6+10	250	24	1	tk

Uponor Aqua PLUS kollektori kandja SH

■ Kollektori kandur



Art. nr.	Dimension	2. pak.	pakend	UOM
1045451*	3/4" 1"	25	1	kompl.

Uponor Q&E otsik väliskeere PL

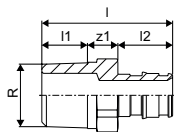

Art. nr.	Dimension	l	l1	l2	R	z1	p	2. pak.	pakend	UOM
		mm	mm	mm	mm	"	mm	bar		
1047191	32-R1"MT	65	21	34	3/4	10	6+10	10	1	tk

Uponor Q&E otsik väliskeere PL/DR

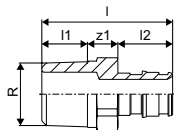

Art. nr.	Dimension	l	l1	l2	R	z1	p	2. pak.	pakend	UOM
		mm	mm	mm	mm	"	mm	bar		
1085077	40-R1 1/4"MT	73	19	42	1 1/4	12	6+10	16	1	tk
1085076	50-R1 1/2"MT	89	20	52	1 1/2	17	6+10	8	1	tk
1085075	63-R2"MT	100	24	65	2	11	6+10	6	1	tk
1085074	75-R2 1/2"MT	126	27	86	2 1/2	13	6+10	6	1	tk

Uponor Q&E

Uponor Q&E otsik väliskeere PL

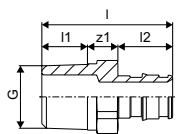

Art. nr.	Dimension	l	l1	l2	G	z1	p	2. pak.	pakend	UOM
		mm	mm	mm	"		mm bar			
1033435	16-G1/2"MT	36	10	18	1/2	8	6+10	100	5	tk
1033437	20-G1/2"MT	40	9	22	1/2	9	6+10	90	5	tk
1033438	20-G3/4"MT	43	11	22	3/4	10	6+10	70	5	tk
1047862	25-G3/4"MT	48	11	27	3/4	10	6+10	40	5	tk
1047863	25-G1"MT	49	11	27	1	11	6+10	40	5	tk
1047864	50-G1 1/2"MT	82	17	52	1 1/2	13	6+10	8	1	tk

Uponor Q&E otsik väliskeere PL W

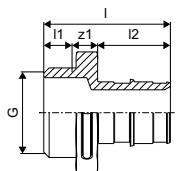

Art. nr.	Dimension	l	l1	l2	G	z1	p	2. pak.	pakend	UOM
		mm	mm	mm	"		mm bar			
1008730	32-G1"MT	56	10	34	1	12	6+10	20	1	tk
1008732	40-G1 1/4"MT	68	14	42	1 1/4	12	6+10	8	1	tk
1008866	50-G1 1/4"MT	78	14	52	1 1/4	12	6+10	8	1	tk
1008867	63-G2"MT	95	17	65	2	13	6+10	6	1	tk

Uponor Q&E otsik sisekeere PL

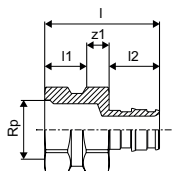

Art. nr.	Dimension	l	l1	l2	Rp	z1	p	2. pak.	pakend	UOM
		mm	mm	mm	"		mm bar			
1023009	16-Rp1/2"FT	41	15	18	1/2	8	6+10	60	5	tk
1023010	20-Rp1/2"FT	44	15	22	1/2	7	6+10	60	5	tk
1023011	20-Rp3/4"FT	46	18	22	3/4	6	6+10	40	5	tk
1023012	25-Rp3/4"FT	51	18	27	3/4	6	6+10	40	5	tk
1023013	25-Rp1"FT	55	22	27	1	6	6+10	35	5	tk

Uponor Q&E otsik sisekeere PL/DR

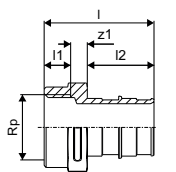

Art. nr.	Dimension	l	l1	l2	Rp	z1	p	2. pak.	pakend	UOM
		mm	mm	mm	"		mm bar			
1085078	50-RP1 1/2"FT	92	21	52	1 1/2	19	6+10	8	1	tk

Uponor Q&E

Uponor Q&E otsik sisekeere PL

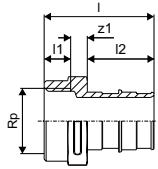

Art. nr.	Dimension	l	l1	l2	G	z	p	2. pak.	pakend	UOM
		mm	mm	mm	mm	mm	mm bar			
1047866	32-G1"FT	56	13	34	1	9	6+10	20	1	tk
1047867	40-G1 1/4"FT	68	16	42	1 1/4	10	6+10	20	1	tk

Uponor Q&E põlv väliskeere PL

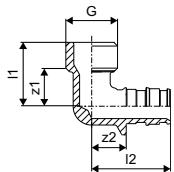

Art. nr.	Dimension	l1	l2	G	z	z	p	2. pak.	pakend	UOM
		mm	mm	mm	mm	mm	mm bar			
1023019	16-G1/2"MT	26	32	1/2	16	14	6+10	80	5	tk
1023020	20-G1/2"MT	29	33	1/2	17	21	6+10	50	5	tk
1023021	20-G3/4"MT	29	36	3/4	18	14	6+10	40	5	tk
1023022	25-G3/4"MT	29	41	3/4	20	14	6+10	40	5	tk
1047878	40-G1 1/4"MT	61	74	1 1/4	46	32	6+10	10	1	tk

Uponor Q&E põlv sisekeere PL

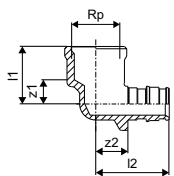

Art. nr.	Dimension	l1	l2	G	z	z	p	2. pak.	pakend	UOM
		mm	mm	mm	mm	mm	mm bar			
1023023	16-G1/2"FT	25	32	1/2	11	14	6+10	70	5	tk
1023024	20-G1/2"FT	25	36	1/2	11	14	6+10	50	5	tk
1023025	20-G3/4"FT	26	39	3/4	10	17	6+10	30	5	tk
1023026	25-G3/4"FT	26	44	3/4	10	17	6+10	35	5	tk

Uponor Q&E kolmik sisekeere PL

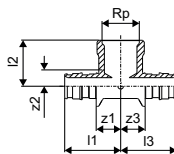

Art. nr.	Dimension	l1	l2	l3	Rp1	z	z	z	p	2. pak.	pakend	UOM
		mm	mm	mm	mm	mm	mm	mm	mm bar			
1047885	16-Rp1/2"FT-16	32	26	32	1/2	14	9	14	6+10	50	5	tk
1047886	20-Rp1/2"FT-20	36	28	36	1/2	14	11	14	6+10	30	5	tk

Uponor Q&E

Uponor Q&E otsik pöördmutriga PL

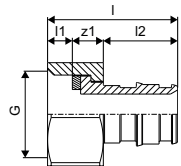

Art. nr.	Dimension	l	l1	l2	G	z1	p	2. pak.	pakend	UOM
		mm	mm	mm	"	mm	bar			
1023014	16-G1/2"SN	32	6	18	1/2	8	6+10	100	5	tk
1023015	20-G1/2"SN	42	8	22	1/2	13	6+10	60	5	tk
1023016	20-G3/4"SN	36	7	22	3/4	8	6+10	50	5	tk
1023017	25-G3/4"SN	49	7	27	3/4	15	6+10	45	5	tk
1023018	25-G1"SN	44	10	27	1	7	6+10	40	5	tk

Uponor Q&E kork

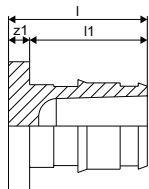

Art. nr.	Dimension	l	l1	z1	2. pak.	pakend	UOM
		mm	mm	mm			
1084671	16	23	20	4	200	20	tk

Uponor Q&E

Uponor Smart Aqua

Kirjeldus

- Kraanipõlved tarbevee ühendusteks
- Q&E rõngad tellida eraldi

Kasutusala

- Tarbevee ühendusteks
- Välis- ja sisekeerved vast. EN 10226-1.

Uponor Smart Aqua U-kraanipõlv Q&E

- U-põlv ringpaigalduseks

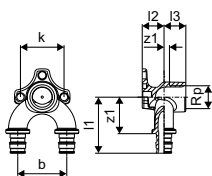

Art. nr.	Dimension	l1	l2	l3	Rp	z1	z2	b	k	2. pak.	pakend	UOM
		mm	mm	mm	mm	mm	mm	mm	mm			
1059820*	16-Rp1/2"FT-16	52	20	20	1/2	34	5	45	40	5	1	tk
1059821*	20-Rp1/2"FT-20	56	20	20	1/2	35	5	45	40	5	1	tk

Uponor Smart Aqua kraanipõlv Q&E PL

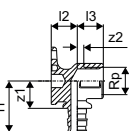

Art. nr.	Dimension	l1	l2	l3	Rp	z1	z2	p	2. pak.	pakend	UOM
		mm	mm	mm	mm	mm	mm	bar			
1059822	16-Rp1/2"FT	39	20	20	1/2	21	5	6+10	40	5	tk
1059823	20-Rp1/2"FT	40	20	20	1/2	18	5	6+10	40	5	tk

Uponor Smart Aqua kraanipõlve paigaldusplaat

- Galvaniseeritud teras.
- Uponor Smart Aqua kraanipõlvede paigaldamiseks
- Positioneerimine vastavalt eeltöödeldud avadele
- Komplektis plastihvitiid ja kruvid vastavalt DIN 965
- Kinnitusavad täpseks paigalduseks

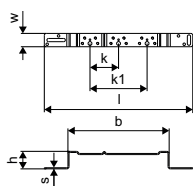
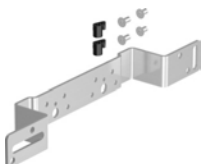

Art. nr.	Dimension	l	s	b	h	k	k1	w	2. pak.	pakend	UOM
		mm	mm	mm	mm	mm	mm	mm			
1057842	75/150mm	390	3	266	46	75	150	35	165	5	tk

Uponor Q&E

Uponor Smart Aqua kraanipõlve paigaldusplaat

- Galvaniseeritud teras.
- Uponor Smart Aqua kraanipõlvede paigaldamiseks
- Positsioneerimine vastavalt eeltöödeldud avadele
- Komplektis plasttihvtid ja kruvid vastavalt DIN 965
- Kinnitusavad täpseks paigalduseks

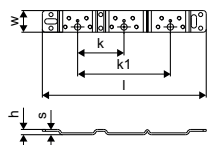
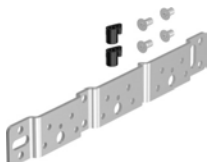

Art. nr.	Dimension	l mm	s mm	h mm	k mm	k1 mm	w mm	2. pak.	pakend	UOM
1057840	75/150mm	265	3,0	9	75	150	35	5	1	tk

Uponor Smart Aqua kraanipõlve paigaldusnurk

- Galvaniseeritud teras.
- Uponor Smart Aqua kraanipõlvede paigaldamiseks
- Positsioneerimine vastavalt eeltöödeldud avadele
- Komplektis plasttihvtid ja kruvid vastavalt DIN 965
- Kinnitusavad täpseks paigalduseks

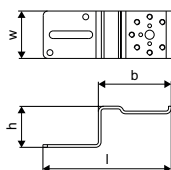
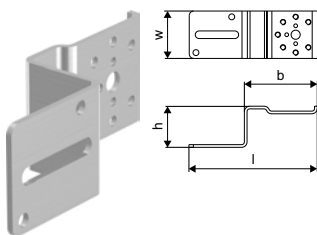

Art. nr.	l mm	b mm	h mm	2. pak.	pakend	UOM
1057843	144	82	46	5	1	tk

Uponor Smart Aqua kraanipõlve paigalduslatt 2m

- Galvaniseeritud teras.
- Uponor Smart Aqua kraanipõlvede paigaldamiseks
- Positsioneerimine vastavalt eeltöödeldud avadele
- Komplektis plasttihvtid ja kruvid vastavalt DIN 965
- Kinnitusavad täpseks paigalduseks

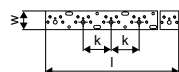
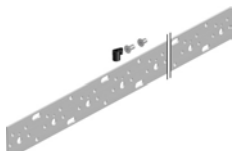

Art. nr.	Dimension	l mm	k mm	2. pak.	pakend	UOM
1057844	2m	2000	75	10	1	tk

Uponor Q&E

Uponor Smart Aqua kraanipölv Q&E PL



Art. nr.	Dimension	l1	l2	l3	Rp	z	z	k	p	2. pak.	pakend	UOM
		mm	mm	mm	"	mm	mm	mm	bar			
1023034	16-Rp1/2"FT l=43mm	32	17	27	1/2	14	10	36	6+10	40	5	tk
1023035	20-Rp1/2"FT l=43mm	36	17	27	1/2	14	10	36	6+10	40	5	tk

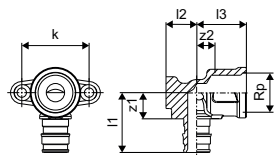

Uponor Smart Aqua mürasummuti

- komplekt kahele Uponor Smart Aqua kraanipölevele 16-Rp1/2"SK või 20-Rp1/2"SK
- komplektis tihvtid ja kruvid M6 x 16
- materjal EPDM.
- heli summutus vastavalt DIN 4109.



NEW

Art. nr.	l1	l2	z	pakend	UOM
	mm	mm	mm		
1057846*	30	18	6	1	kompl.

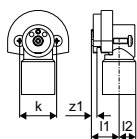

Uponor Q&E

Uponor Smart Radi

Kirjeldus

- Liitmikud ja tarvikud radiaatorite ühendamiseks
- Q&E rõngad tellida eraldi

Kasutusala

- Kõrge- ja madalatemperatuuriline radiaatorküte

Uponor Smart Radi radiaatori ühenduspõlv kroom Q&E

- pinnakattega messing
- vasktoru 15 x 1 mm, pinnakattega.
- Vasktoru 15 x 1 mm ühendamiseks radiaatoriga kasutada Uponor vase surveliitmikku (art.nr. 1013830).

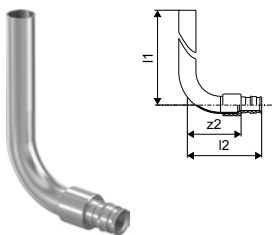

Art. nr.	Dimension	l1 mm	l2 mm	z mm	p bar	2. pak.	pakend	UOM
1023045	16-15CU l=300mm	300	65	47	6+10	40	2	tk
1023046	20-15CU l=300mm	300	69	47	6+10	30	2	tk

Uponor Smart Radi radiaatori ühenduskolmik kroom Q&E

- pinnakattega messing
- vasktoru 15 x 1 mm, pinnakattega.
- Vasktoru 15 x 1 mm ühendamiseks radiaatoriga kasutada Uponor vase surveliitmikku (art.nr. 1013830).

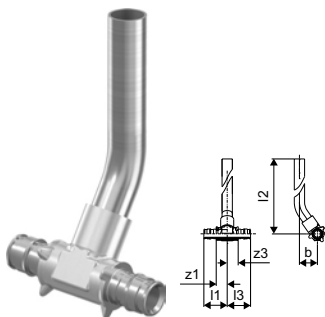

Art. nr.	Dimension	l1 mm	l2 mm	l3 mm	z1 mm	z2 mm	p bar	2. pak.	pakend	UOM
1023049*	16-15CU-16 l=300mm	34	302	34	16	16	6+10	30	2	tk
1023050*	20-15CU-20 l=300mm	39	302	39	17	17	6+10	30	2	tk

Uponor Smart Radi paindetugi

- Valge plast.
- Põrandast tuleva 16 mm PE-Xa või MLC toru ühendamiseks radiaatoriga.
- Koostatav, hülsstorule 25/20 mm.
- Min. c/c 40 mm, komplektis 5 mm vahetükk.



Art. nr.	Dimension	l mm	l1 mm	b mm	b1 mm	b2 mm	h mm	h1 mm	w mm	pakend	UOM
1009008	25/20mm	100	21	41	24	46	122	28	30	10	tk

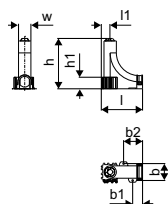

Uponor AQUA PLUS

Uponor Aqua PLUS

Kirjeldus

- Veetihedad kollektorikapid vastavalt NT VVS 129
- Kollektoritele \leq c 50 mm
- M7 läbiviigid hülssidele
- Komplektis kapp, pritsmekaitse ja tarvikukomplekt koos kollektori klambritega
- Uks ja raam tuleb tellida eraldi
- RAL 9010
- Plastkollektorid paigaldamiseks veetihedatesse kappidesse
- Paigaldistes ilma kollektori kappideta ei saa rakendada NT VVS 129 veetiheduse garantiid
- Kollektoreid ja tarvikuid kasutada komplekselt
- Metallliitmikud kõrgekvaliteedilisest messingist
- Plastliitmikud PPSU
- PPM kollektorid bajonettkeermega

Kasutusala

- Veetihe paigaldis kahjude vältimiseks võimaliku lekke korral
- Igat tüüpi kollektorpaigaldistele

Uponor Aqua PLUS FS lekkekindel kollektorikapp

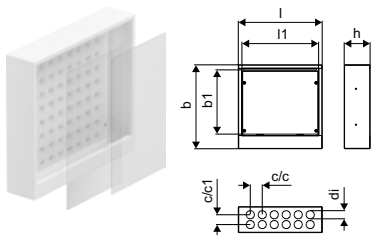

Art. nr.	Dimension	l mm	l1 mm	d1 mm	c mm	c1 mm	b mm	b1 mm	h mm	värvus	uPoints	2. pak.	pakend	UOM
1088752	A, 350x350x108mm	350	320	34	50	41	350	268	108	RAL 9010	500	32	1	tk
1088751	A, 350x350x118mm	350	320	34	50	41	350	268	118	RAL 9010	450	32	1	tk
1088759	B, 550x500x108mm	550	520	34	50	41	500	418	108	RAL 9010	500	20	1	tk
1088758	B, 550x500x118mm	550	520	34	50	41	500	418	118	RAL 9010	550	12	1	tk
1088768	C, 750x500x108mm	750	720	34	50	41	500	418	108	RAL 9010	650	16	1	tk
1088767	C, 750x500x118mm	750	720	34	50	41	500	418	118	RAL 9010	650	16	1	tk

Uponor Aqua PLUS kapi raam



Art. nr.	Dimension	l mm	l1 mm	b mm	b1 mm	h mm	värvus	2. pak.	pakend	UOM
1088754	A, 390x385mm	390	320	385	268	18	RAL 9010		1	tk
1088762	B, 590x535mm	590	520	535	418	18	RAL 9010	50	1	tk
1088770	C, 790x535mm	790	720	535	418	18	RAL 9010	46	1	tk

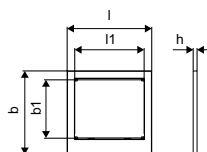

Uponor AQUA PLUS

Uponor Aqua PLUS kapi uks

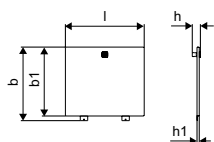

Art. nr.	Dimension	l mm	b mm	b1 mm	h mm	h1 mm	värvus	2. pak.	pakend	UOM
1088753	A, 320x280mm	318	297	278	33	9	RAL 9010	116	1	tk
1088761	B, 520x430mm	518	447	428	33	9	RAL 9010		1	tk
1088769	C, 720x430mm	718	447	428	33	9	RAL 9010		1	tk

Uponor Aqua PLUS kapi läbiviik M7

- Läbiviik M7 kappidele
- Kasutatav nii toru-torus paigaldusel kui ka ainult voolutoruga

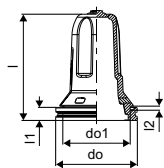

Art. nr.	Dimension	l mm	l1 mm	l2 mm	do mm	do1 mm	2. pak.	pakend	UOM
1063404	M 25/20-28/23 20-28mm	52	6	2	40	33	100	10	tk
1063405	L 34/28	87	40	2	45,5	33	50	2	tk
1064542	XL 54/48 32-40mm	72	25	2	67,4	59	50	2	tk

Uponor Aqua PLUS kapi ülevool M7

- Lekke indikaator
- 25/20 hülssstorule
- Vast. NT VVS 129



Art. nr.	Dimension	d2 mm	2. pak.	pakend	UOM
1063462	25/20mm	25/20	100	10	tk

Uponor Aqua PLUS lekkeindikaator M7

- Lekke indikaatori komplekt seinakarbiga
- 25/20 hülssstorule
- Vast. NT VVS 129



Art. nr.	2. pak.	pakend	UOM
1062958	50	1	tk

Uponor AQUA PLUS

Uponor Aqua PLUS kollektor Q&E PPM

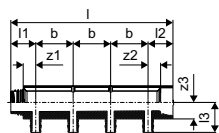

Art. nr.	Dimension	l	l1	l2	l3	z1	z2	z3	b	väljundid	p	2. pak.	pakend	UOM
		mm	mm	mm	mm	mm	mm	mm	mm	-	bar			
1047999	1" 2X16 c/c50mm	117	33	33	40	17	17	22	50	2	6+10	10	1	tk
1048000	1" 3X16 c/c50mm									3	6+10	8	1	tk
1048001	1" 4X16 c/c50mm									4	6+10	6	1	tk

Uponor Aqua PLUS kollektor PPM

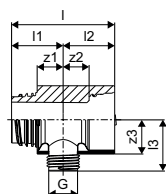

Art. nr.	Dimension	l	l1	l2	l3	G	z1	z2	z3	väljundid	p	2. pak.	pakend	UOM
		mm	mm	mm	mm	mm	mm	mm	mm	-	bar			
1047997	1" 1XG1/2"MT c/c50mm	67	33	33	33	1/2"	17	17	23	1	6+10	20	1	tk
1047998	1" 1XG3/4"MT c/c50mm									1	6+10	20	1	tk

Uponor Aqua PLUS kollektori ühendus sirge PPM

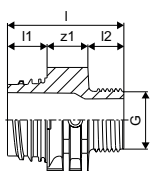

Art. nr.	Dimension	l	l1	l2	G	z1	p	2. pak.	pakend	UOM
		mm	mm	mm	mm	mm	mm			
1048002	1" G3/4"MT	49	17	15	3/4	17	6+10	20	1	tk

Uponor Aqua PLUS kollektori nurkühendus PPM

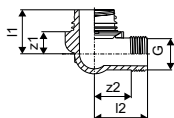

Art. nr.	Dimension	l1	l2	G	z1	z2	2. pak.	pakend	UOM
		mm	mm	mm	mm	mm			
1048003	1" G3/4"MT	33	40	3/4	17	28	20	1	tk

Uponor Aqua PLUS kollektori otsakork PPM

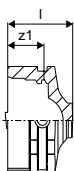
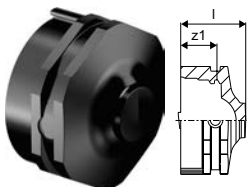

Art. nr.	Dimension	l	z1	2. pak.	pakend	UOM
		mm	mm			
1048004	1"FT	27	15	20	1	tk

Uponor AQUA PLUS

Uponor Aqua PLUS kollektori otsakork õhutusega PPM

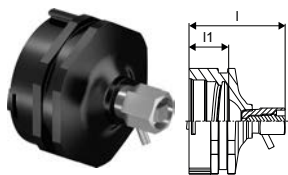

Art. nr.	Dimension	l mm	l1 mm	2. pak.	pakend	UOM
1048005	1"FT	40	17	20	1	tk

Uponor Aqua PLUS kollektori kandja PPM



Art. nr.	l	l1	l2	l3	L	di	z	z1	b	b1	b2	h	h1	2. pak.	pakend	UOM
	mm	mm	mm	mm	m	mm	mm	mm	mm	mm	mm	mm	mm			
1092021	36	38	75	150	300	6	14	62	123	102	48	58	32	50	1	kompl.

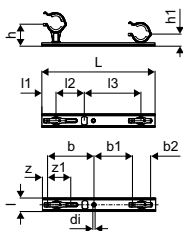

Uponor AQUA PLUS

Uponor Aqua PLUS kollektori otsakork

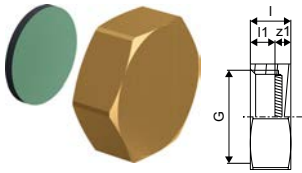

Art. nr.	Dimension	l	l1	G	z	2. pak.	pakend	UOM
		mm	mm	"	mm			
1001337	3/4"FT	12	7	3/4	5	250	10	tk

Uponor Smart Aqua PLUS

Kirjeldus

- Seinakarbid koos põlvedega Uponor PE-Xa torude ja Uponor hülsstorude veetihedaks ühendamiseks
- Veetihedus vast. NT VVS 129
- Metallliitmikud: kõrgekvaliteediline DR messing
- Plastliitmikud: PPSU
- PPM kollektorid bajonett-keermega
- Komplektis Q&E rõngas

Kasutusala

- Veetihe paigaldis kahjude vältimiseks võimaliku lekke korral
- Kõikidele paigaldistele, kus nõutakse torude ja hülsstorude veetihedat ühendamist

Uponor Smart Aqua PLUS ühenduskarp Q&E M7a DR

- Ühenduskarbi sees Q&E messingpõlv



Art. nr.	Dimension	d	IG	p	uPoints	2. pak.	pakend	UOM
		mm	"	bar				
1086208	16-Rp1/2"FT	16	Rp 1/2	10	50	50	1	tk
1086210	20-Rp1/2"FT	20	Rp 1/2	10	50	50	1	tk

Uponor Smart Aqua PLUS tihendusmembraan M7

- tihendusmembraan



Art. nr.	pakend	UOM
1062964	1	tk

Uponor Teck hülsstoru jätk M7

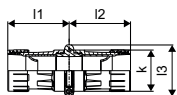

Art. nr.	Dimension	l1	l2	l3	k	pakend	UOM
		mm	mm	mm	mm		
1062956	25-28mm	66	66	55	44	1	tk

Uponor RS plasttorule

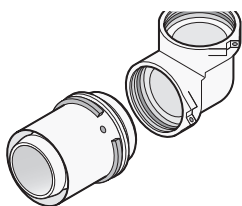

Uponor RS on unikaalne moodulsüsteem püstakute ja magistraalitorustike ehitamiseks. 40 komponendist süsteem võimaldab koostada sadu erinevaid variatsioone

Eelised

- Unikaalne ühendus korpuse ja adapterite vahel
- Kiire ja paindlik: tööriistavaba ühendus, palju variante
- Efektivsem laomajanduse juhtimine
- Muutmise võimalus paigalduse käigus
- Värvkoodid läbimõõdul 16 -110mm



Uponor RS siirdmik PL Q&E

- RS liitmik PEX torudele
- PL messing
- Uponor Q&E rõngad tellida eraldi

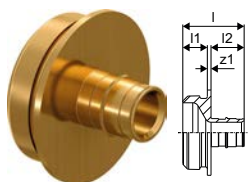

Art. nr.	Dimension	l	l1	l2	z	p		
		mm	mm	mm	mm	mm	bar	pakend UOM
1047021*	25-RS2	50	20	27	3	6+10		1 tk
1047022*	32-RS2	57	20	34	3	6+10		1 tk
1047023*	40-RS2	65	20	42	3	6+10		1 tk
1047024*	50-RS2	75	20	52	3	6+10		1 tk
1047026	63-RS2	88	20	65	3	6+10		1 tk

Uponor RS siirdmik PL/DR Q&E

- RS liitmik PEX torudele
- DR messing
- Uponor Q&E rõngad tellida eraldi

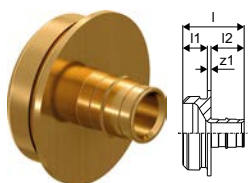

Art. nr.	Dimension	l	l1	l2	z	p		
		mm	mm	mm	mm	mm	bar	2. pak. pakend UOM
1085079*	75-RS2	111	20	86	5	6+10		6 1 tk

Uponor RS äärik

- Tinatatud messing
- Ühildub kõikide RS2 või RS3 baasdetailidega
- Äärik PN6/PN16 vast. EN 1092-3
- 4/8 kinnituspoltide ava.

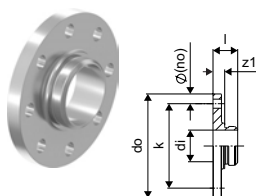

Art. nr.	Dimension	l	l3	di	do	z	k	p		
		mm	mm	mm	mm	mm	mm	mm	bar	pakend UOM
1059398	RS2-DN65 (PN6)	38	18	48,7	160	18	130	6		1 tk
1059399	RS2-DN65 (PN16)	45	25	48,7	185	25	145	16		1 tk
1059400	RS3-DN80 (PN6)	38	18	78,1	190	18	150	6		1 tk
1029129	RS3-DN80 (PN16)	45		78,1	200	25	160	16		1 tk
1029130	RS3-DN100 (PN16)	44		78,1	220	24	180	16		1 tk
1059401	RS3-DN100 (PN6)	41	21	78,1	210	21	170	6		1 tk

Uponor RS

Uponor RS lukusti

- plastik
- RS siirdmike lukustamiseks RS baasdetailide külge.



Art. nr.	Dimension	värvus	pakend UOM	
1042921	RS2 black	must	10	tk
1042922	RS3 grey	Hall (RAL 7015)	10	tk

Uponor põrandaküttetorud

Vaata toru sobivust paigaldussüsteemide kirjeldustes

Uponor Smart põrandküttetoru

- PE-RT põrandkütte toru
- 5-kihiline
- vastab ISO 22391 ja täidab DIN 4726 nõuded hapniku difusiooni takistuse osas
- kasutatav koos Uponor Smart surveliitmikega
- kasutusklass 4
- tööõhk 6 bar temp. 70°C

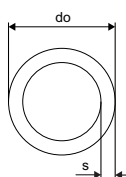

Art. nr.	Dimension	L m	do mm	s mm	p bar	värvus -	uPoints	2. pak.	pakend	UOM
1086570	14x2,0 240m	240	14	2,0	6	nat.	250	1680	240	m
1086575	16x2,0 240m	240	16	2,0	6	nat.	250	1440	240	m
1086576	16x2,0 640m	640	16	2,0	6	nat.	700	1280	640	m
1086577	20x2,0 240m	240	20	2,0	6	nat.	300	960	240	m
1086578	20x2,0 480m	480	20	2,0	6	nat.	600	960	480	m

Uponor Smart surveliitmik

- Eurokoonus
- Messing
- 3/4" kollektoritele

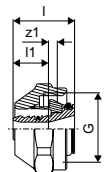

Art. nr.	Dimension	l mm	l1 mm	G "	z1 mm	p bar	2. pak.	pakend	UOM
1086580	14x2,0-G3/4"FTEuro	23	13	3/4	3	6	40	2	tk
1086582	16x2,0-G3/4"FTEuro	23	13	3/4	3	6	40	2	tk
1086583	20x2,0-G3/4"FTEuro	24	14	3/4	3	6	40	2	tk

Uponor Smart pressjätk

- Pressjätk
- messing
- Uponor Smart ja Comfort Pipe PLUS torudele

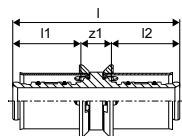

Art. nr.	Dimension	l mm	l1 mm	l2 mm	z1 mm	p bar	2. pak.	pakend	UOM
1089646	14x2,0-14x2,0	52	21	21	9	6	80	10	tk
1089647	16x1,8/2,0-16x1,8/2,0	52	21	21	9	6	80	10	tk

Uponor põrandaküttetorud

Uponor Comfort Pipe PLUS

Kirjeldus

- Peroksiid ristseotud polüetüleenist (PE-Xa) valmistatud torud vast. EN ISO 15875
- EVOH (etüül vinüül alkohol) kiht hapniku difusiooni takistamiseks vast. DIN 4726
- 5 kihiline
- Välimine PE kiht mehaaniliste vigastuste vältimiseks
- Kasutusklass 4 - Põrandaküte ja madalatemperatuuriline radiaatorküte
- Tuleklass E vastavalt DIN EN 13501-1.

Kasutusala

- Põrandküte ja madalatemperatuuriline radiaatorküte
- Küte
- Max temperatuur: 90°C
- lühiajaline avariitemperatuur 100°C
- Arvestuslik rõhk 6 bar, 70°C

Uponor Comfort Pipe PLUS

- 6/10 bar temp. 90°C/70°C

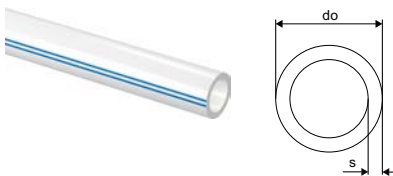

Art. nr.	Dimension	L m	do mm	s mm	p bar	V l/m	värvus -	uPoints	2. pak.	pakend UOM
1062045	16x2,0 240m	240	16	2,0	6	0,113	valge	700	1440	240 m
1062046	16x2,0 640m	640	16	2,0	6	0,113	valge	2600	1280	640 m
1062884	14x2,0 240m	240	14	2,0	6	0,079	valge	650	1680	240 m
1062885	14x2,0 960m	960	14	2,0	6	0,079	valge	2500	1920	960 m

Uponor Comfort Pipe PLUS toru

- 6/8 bar temp. 90°C/70°C

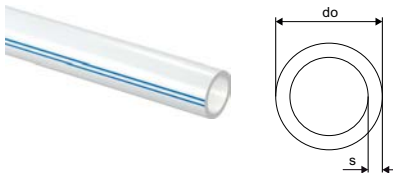

Art. nr.	Dimension	L m	do mm	s mm	p bar	V l/m	värvus -	uPoints	2. pak.	pakend UOM
1009228	20x2,0 120m	120	20	2	6	0,200	valge	600	840	120 m
1009230	20x2,0 240m	240	20	2,0	6	0,200	valge	1000	960	240 m
1009231	20x2,0 480m	480	20	2	6	0,200	valge	1850	960	480 m

Uponor Comfort Pipe PLUS toru

- 6 bar temp. 90°C

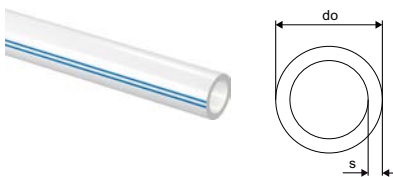

Art. nr.	Dimension	L m	do mm	s mm	p bar	värvus -	uPoints	2. pak.	pakend UOM
1062888	25x2,3 220m	220	25	2,3	6	valge	900	440	220 m
1062889	25x2,3 300m	300	25	2,3	6	valge	1200	600	300 m
1063907	25x2,3 640m	640	25	2,3	6	valge	2400		640 m

Uponor Vario surveiliitmik PEX

- Eurokoonus
- Messing



Art. nr.	Dimension	l mm	l1 mm	G "	z1 mm	2. pak.	pakend UOM
1065283	14x2,0-G3/4"FTEuro	23	13	3/4	3	25	1 tk
1065284	16x1,8/2,0-G3/4"FTEuro	23	13	3/4	3	25	1 tk
1065290	20x1,9/2,0-G3/4"FTEuro	24	14	3/4	3	25	1 tk

Uponor põrandaküttetorud

Uponor MLCP RED

Kirjeldus

- Hapniku difusioonikindel komposiitтору (PE-RT - sidekiht - pikisuunas keevitatud alumiinium - sidekiht - PE-RT)
- Materjali klass B2 vastavalt DIN 4102.

Kasutusala

- Max püsiv töö rõhk: 4 bar
- Max püsiv töötemperatuur 60°C.

Uponor MLCP RED toru

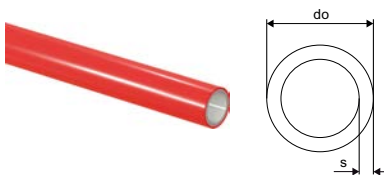

Art. nr.	Dimension	L m	do mm	s mm	uPoints	2. pak.	pakend UOM
1047001	14x1,6 200m	200	14	1,6	300	2600	200 m
1047002	14x1,6 500m	500	14	1,6	800	3500	500 m
1047003	16x2,0 200m	200	16	2,0	400	2600	200 m
1047004	16x2,0 500m	500	16	2,0	1000	3500	500 m

Uponor Vario surveliitmik MLCP RED

- messing
- 3/4" eurokoonus sisekeermega liitmik Uponor MLC punase PK/jahutuse torude ühendamiseks Uponor kollektoritega.
- Rõngastihendi värvus: punane

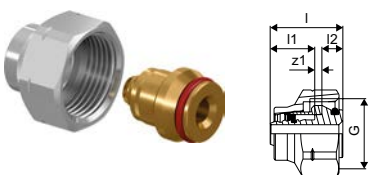

Art. nr.	Dimension	l mm	l1 mm	l2 mm	z1 mm	2. pak.	pakend UOM
1000117	14x1,6-3/4" Euro	27	17	8	3	80	10 tk

Uponor MLCP RED pressliitmik

- MLCP RED toru jätk
- Tinatatud messing
- Fikseeritud presshülssidega, värvkood stoppervõrude ja lekkeindikaatoriga.
- Pressitav ilma faasimiseta

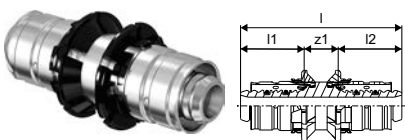

Art. nr.	Dimension	l mm	l1 mm	l2 mm	z1 mm	2. pak.	pakend UOM
1048272	14x1,6-14x1,6	54	21	21	11	80	10 tk

Uponor Multi paindetugi galv teras

- Tsingitud teras
- Paindetugi 90°

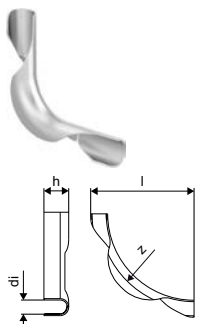

Art. nr.	Dimension	l mm	di mm	z mm	h mm	r mm	värvus	pakend UOM
1009004	-16	100	16,3	63	15	63	galv steel	10 tk
1009233	-20	132	20	102	20	102	galv steel	20 tk
1009006	-25	170	25,5	134	22	134	galv steel	10 tk
1001231	-34	210	32	137	28	137	galv steel	2 tk

Uponor Nubos

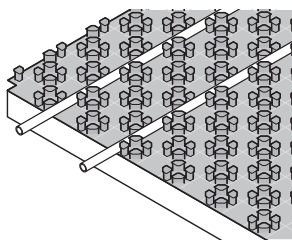

Uponor Nubos on välja töötatud spetsiaalselt põrandakütte/-jahutuse süsteemidele. Paneelid paigaldatakse põrandale tsement või anhidriid tasandussegu alla.

Eelised

- Lihtne: õhuke, optimaalselt sobivad komponendid
- Kasutatav nii komposiit- kui ka PE-Xa torudega (läbim 14/16)
- Kestev ja kvaliteetne



Kirjeldus

- Nubos paigalduspaneel 14 - 16 mm torude fikseerimiseks.
- Torude võimalikud paigaldussammud: 5,5 11 16,5 22 27,5 33 cm
- **Sobivad torud : Comfort Pipe Plus, Smart , MLCP RED**
- EN 13501-1 tuleklass: klass E
- Standardne süttivus, ehitusmaterjal klass B2, vast. DIN 4102

Kasutusala

- põrandaküttele ja -jahutusele
- kasutatakse koos betoon ja anhidriidsegudega
- ilma isolatsioonita

Sertifitseerimine

- DIN CERTCO: 7F335-F; 7F336-F; 7F337-F; 7F338-F

Uponor Nubos paigalduspaneel

- Paigalduspaneel plastikust ilma isolatsioonita



Art. nr.	Dimension	s MN/m ²	l mm	b mm	h1 mm	A m ²	värvus -	Area	uPoints	2. pak.	pakend	UOM
1016703	14-16mm	-	1447	900	18	1.25	RAL 9017	1.302	100	140	10	m ²

Uponor Tacker

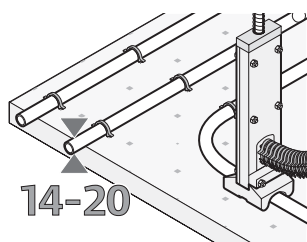

Tacker klambrid toru kinnitamiseks isolatsioonplaadile
Soovitav on kasutada lamineeritud EPS plaate
Sobib kõikide pörandakütetorude kinnitamiseks.

Eelised

- **Paindlik:** Torude kinnitamiseks klambritega isolatsiooniplaadile
- **Sobib erinevatele pörandasegudele**
- **Universaalsed toruklambrid torudele 14 – 20mm**
- **Lihtne paigaldus:** ergonomiline klambripaigaldiga



Kirjeldus

- Tacker pörandaküttesüsteem.
- Torude kinnitusklambrid torudele 14-20 mm
- **Sobivad torud : Comfort Pipe Plus, Smart , MLCP RED**

Kasutusala

- pörandaküttele ja -jahutusele
- sobilik nii betoon kui ka anhüdriidsegudega paigaldistes

Sertifitseerimine

- DIN CERTCO: 7F077-F, 7F185-F, 7F216-F, 7F278-F

Uponor Tacker tacker klamber, lühike

- Tacker kinnitusklamber
- Kasutatakse koos Uponor Tacker klambripaigaldiga

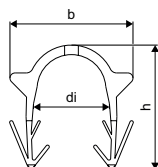

Art. nr.	Dimension	di mm	b mm	h mm	2. pak.	pakend UOM
1086528	14-20mm h=35mm	22,1	36	36	6000	300 tk

Uponor Tacker Tacker kinnitusklamber standard

- Tacker kinnitusklamber
- Kasutatakse koos Uponor Tacker klambripaigaldiga

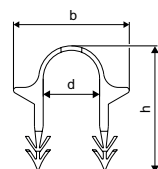

Art. nr.	Dimension	di mm	b mm	h mm	pakend UOM
1086529	14-20mm h=40mm	19	39	43	1000 tk

Uponor Tacker

Uponor Tacker toru kinnitusklamber, pikk

- Tacker kinnitusklambrid
- Kasutatakse koos Uponor Tacker klambripaigaldiga

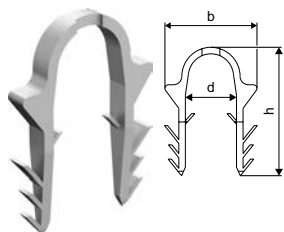

Art. nr.	Dimension	do mm	b mm	h mm	pakend	UOM
1086530	55mm	21,5	37	54	300	tk

Uponor Fix kinnitusprofiil

- kinnitusprofiil torudele 14 ja 16 mm
- c-c 50mm

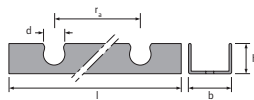
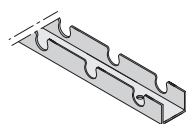

Art. nr.	Dimension	d mm	l mm	b mm	h mm	õ c mm	värvus	pakend	UOM
1005498	14mm c/c50mm 2,5m	14	2500	38	17	50	Hall (RAL 7015)	25	m

Uponor Fix kinnitusprofiil kleepribaga

- 14-20mm torude kinnitusprofiil
- c-c 50mm
- iseliimuva põhjaga



Art. nr.	Dimension	l mm	b mm	h mm	õ c mm	2. pak.	pakend	UOM
1000018	14-20mm c/c50mm 1m	1000	50	27	50	600	100	m

Uponor Classic

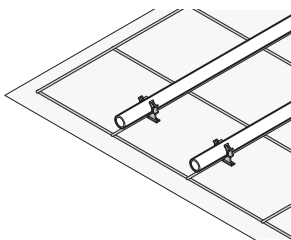

Uponor Classic on klassikaline põrandkütte ja -jahutuse lahendus elamuehituses ja ärihoonetes. Sobib kasutamiseks ka suurte koormustega põrandates.

Eelised

- Klassikaline paindlik, kiire ja lihtne paigaldus
- Võimalik kasutada erinevaid isolatsioonimaterjale
- Kindel: pikaajaline, läbiproovitud süsteem



Kirjeldus

- Classic süsteemi puhul kinnitatakse torud soojus- ja sammumüra isolatsiooni peale.
- Torude kinnitus armatuurvõrgu külge sidumistraadi või kaablisidemetega
- **Sobivad torud : Comfort Pipe Plus, Smart , MLCP RED**

Kasutusala

- põrandaküttele ja -jahutusele
- kasutatakse koos betoon ja anhidriidsegudega

Sertifitseerimine

- DIN CERTCO: 7F004-F; 7F371-F; 7F421-F

Uponor Classic sidumistraat

- terastraat torude kinnitamiseks armatuurvõrgule
- kasutamiseks koos Uponor sidumiskonksuga



Art. nr.	Dimension	l mm	pakend	UOM
1009222	150x1,25mm	250pcs	1	tk

Uponor Siccus 14

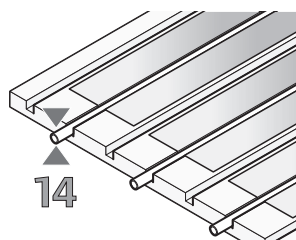

Uponor Siccus 14 võimaldab pörandakütte rajamist ilma valutöödeta. Ideaalne lahendus laagidel pörandade puhul. Kasutatav ka seinakütte rajamiseks.

Eelised

- Kaalult kerge pörandakonstruktsiooni rajamiseks
- Kiire paigaldus: kipsplaadist pinnakiht koheselt koormatav
- Kuivpaigalduseks: veevaba, ei vaja kuivamisaega
- Universaalne: kasutatav 14 mm MLC RED või Comfort Pipe Plus torudega



Kirjeldus

- Siccus pörandaküttesüsteem koosneb EPS isolatsiooniplaadist ja alumiiniumist soojusjaotusplaatidest.
- EN 13501-1 tuleklassifikatsioon: klass E.
- Kasutusklass vast. DIN 4108-10: DEO dh, WI
- Koormustaluvus vast. EN 1991-1-1 = 7,5kN/m²
- Torude paigaldussamm c-c 150mm
- **Sobivad torud : 14 mm Comfort Pipe Plus, MLCP RED**

Kasutusala

- Pörandaküte ja -jahutus
- Kuivpaigaldus

Sertifitseerimine

- DIN CERTCO: 7F008-F, 7F009-F, 7F332-F

Uponor Siccus 14 paneel

- Soontega paigaldusplaat
- EPS survetugevus: = 150 kPa
- R=0.622 m²K/W
- Plaadi pindala 1,25 m²

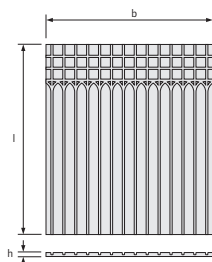

Art. nr.	Dimension	G kN/m ²	ND -	l mm	R-arv m ² K/W	b mm	h mm	A m ²	uPoints	2. pak.	pakend UOM
1005485	EPS 150kPa 14mm 1197x1050x25mm	75	25	1197	0,622	1050	25	1.25	200	100	12,5 m ²

Uponor Siccus 14 soojusjaotusplaat

- alumiiniumist soojusjaotusplaat kasutamiseks Uponor kuivpaigaldusega PK süsteemides torule 14mm
- eelstantsitud murdekohad
- materjali kulu = 5.6 tk/m² (c-c150mm)

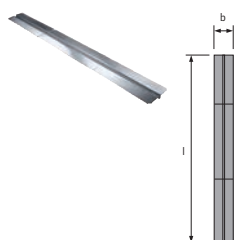

Art. nr.	Dimension	l mm	b mm	2. pak.	pakend UOM
1005486	14mm 1180x120x0,45mm	1180	120	768	48 tk

Uponor Siccus 14

Uponor Siccus 14 PS soonelõikur

- EPS plaatide kuumlõikur
- 230V, 50/60Hz
- soonte lõikamiseks 14mm torudele



Art. nr.	Dimension	TP V	2. pak.	pakend	UOM
1006290	14mm 230V	230	20	1	tk

Uponor Siccus 20

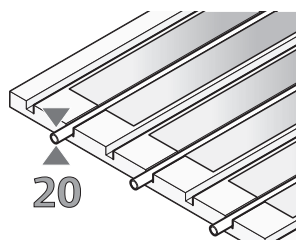

Uponor Siccus 20 võimaldab põrandakütte rajamist ilma valutöödeta. Ideaalne lahendus laagidel põrandade puhul. Kasutatav ka seinakütte rajamiseks.

Eelised

- Kaalult kerge põrandakonstruktsiooni rajamiseks
- Kiire paigaldus: kipsplaadist pinnakiht koheselt koormatav
- Kuivpaigalduseks: veevaba, ei vaja kuivamisaega
- Universaalne: kasutatav 20 mm Comfort Pipe Plus torudega



Kirjeldus

- Siccus põrandküttesüsteem koosneb EPS isolatsiooniplaadist vast. EN 13163 ja alumiiniumist soojusjaotusplaatidest.
- EN 13501-1 tuleklassifikatsioon: klass E.
- Koormustaluvus vast. EN 1991-1-1 = 7,5kN/m²
- Torude paigaldussamm c-c 300 mm
- **Sobivad torud : 20 mm Comfort Pipe Plus, Smart**

Kasutusala

- põranda- ning seinaküte ja -jahutus
- kuivpaigaldus

Uponor Siccus 20 paneel

- Soontega paigaldusplaat
- Paksus 30mm
- EPS survetugevus: = 200 kPa
- Kulu: 1,1 plaati/ m²



Art. nr.	Dimension	l mm	Δ c mm	b mm	h mm	ND A m ²	2. pak.	pakend	UOM
1034347	EPS 20mm 1200x790x30mm	1200	300	790	30	30 0,948	25	5	tk

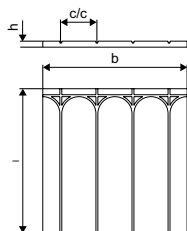

Uponor Multi soojusjaotusplaat

- Alumiiniumist soojusjaotusplaat
- Kasutatakse koos 20 mm torudega, paigaldussamm 300mm
- kulu: 2,5 plaati/m²



Art. nr.	Dimension	l mm	s mm	b mm	2. pak.	pakend	UOM
1009132	20mm 1150x280x0,55mm AL	1150	22,0	280	280	40	tk

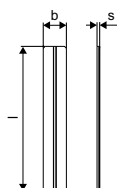

Uponor Magna

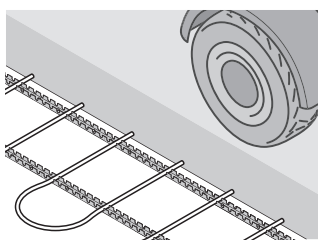

Uponor Magna on tööstusliku põrandakütte süsteem. Betoonpõrandatele. Toru kinnitatakse armatuurvõrgule.

Eelised

- Lihtne ja paindlik: Paigalduseks on vaja vaid väike hulk komponente
- Kuluefektiivne: lühike tasuvusaeg, praktiliselt hooldevaba
- Töökindel ja pikaealine



Kirjeldus

- Tööstuslik põrandaküttesüsteem
- Kuni 20 kontuuri ühe kollektori kohta
- Kandurite arv vastavalt kollektori pikkusele
- Väljundite vahekaugus 100 mm

Kasutusala

- Suurte tootmis- ja äripindade põrandaküttesüsteem
- Betoonpõrandatesse
- Kuni 20 küttekontuuri

Uponor Magna kinnitusprofiil

- kinnitusprofiil torudele 20 ja 25 mm
- c-c 50mm

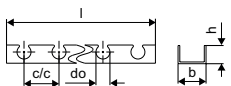

Art. nr.	Dimension	l mm	do mm	do mm	b mm	ND värvus	2. pak.	pakend UOM
1005290*	25mm c/c50mm 3m	3000	25	50	60	-	1320	30 m

Uponor Fit surveliitmik väliskeere

- Messing
- Põrandaküttetoru ühendamiseks kollektoriga

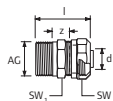
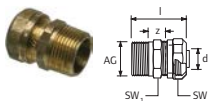

Art. nr.	Dimension	d mm	AG "	l mm	SW mm	z mm	2. pak.	pakend UOM
1005295	25x2,3-R3/4"MT	25	R 3/4	50	37/27	15	100	10 tk
1005298	25x2,3-R1"MT	25	R 1	53	37/34	20	100	10 tk

Uponor Magna

Uponor Fit surveliitmik sisekeere

- Messing
- Põrandaküttetoru ühendamiseks kollektoriga

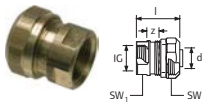

Art. nr.	Dimension	d mm	IG "	l mm	SW mm	z mm	2. pak.	pakend	UOM
1005297	25x2,3-Rp3/4"FT	25	Rp 3/4	35	37/31	8	100	10	tk

Uponor Magna põhikomplekt

- Komplektis: 2 lühikest ja pikka klambrit, 2 messingist täiteventiili, 2 termomeetrit 0 - 60°C, manomeeter, 2 otsakorki, 2 lametihendiga pöördmutriga ühendusotsa 1 1/2" SK, paigaldustarvikud: (8 kruvi 6x60mm, 8 tüüblit 8x40mm, 2 lametihendit 44x32x2)

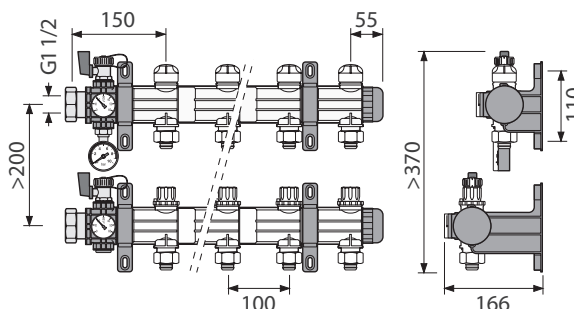

Art. nr.	Dimension	pakend	UOM
1045815	K1	1	tk

Uponor Magna kollektori moodul

- Pealevoolumoodul eelseadeventiiliga
- Tagasivoolumoodul korgiga ventiili sulgemiseks,
- Tagasivoolumoodulile võimalik paigaldada Uponor aiam
- Kütteringi ühendus G3/4 eurokoonusega (ei ole komplektis)



Art. nr.	Dimension	p bar	VN m³/h	2. pak.	pakend	UOM
1045814	G3/4	6	8,0	10	1	tk

Uponor Magna kollektori moodul

- Pealevoolumoodul eelseadeventiilidega
- Tagasivoolumoodul korgiga kütteringi sulgemiseks
- Tagasivoolu moodulile võimalik paigaldada Uponor aiam
- Surveleitmikud kütteringi ühendamiseks PE-Xa 25x2,3 toruga on komplektis



Art. nr.	Dimension	p bar	VN m³/h	2. pak.	pakend	UOM
1045813	dim 25	6	8,0	10	1	tk

Uponor Magna

Uponor SPI Magna kuulkraan, komplekt

- Messing



Art. nr.	Dimension	pakend	UOM
1030135	2x G 1 1/2	1	tk

Uponor Magna kandurikomplekt

- Komplektis: 2 lühikest klambrit, 2 pikka klambrit, paigaldustarvikud: 8x kruvi 6x60mm, 8x tüübel 8x40mm
- Kandurite koguvajadus 6-9 kütteringile 3 kandurit, 10-14 kütteringile 4 kandurit ,
- 15-19 kütteringile 5 kandurit ja 20 kütteringile 6 kandurit



Art. nr.	pakend	UOM
1045816	1	tk

Uponor SPI Magna vooluhulgaregulaator

- Sulgemisfunktsiooniga
- Klaaskiuga armeeritud polüamiid



Art. nr.	2. pak.	pakend	UOM
1030134	20	1	tk

Uponor Multi

Uponor Multi

Kirjeldus

- Põrandakütte erinevate süsteemide paigaldustarvikud ja komponendid

Kasutusala

- Põrandakütte ja jahutussüsteemid

Uponor Multi kinnitusprofiil

- kinnitusprofiil torudele 20 ja 25 mm
- c-c 50mm

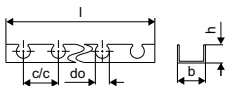

Art. nr.	Dimension	l mm	do mm	d mm	b mm	ND	värvus	2. pak.	pakend	UOM
1005358	20mm c/c50mm 3m	3000	20	50	40	26	RAL 7042	30	3	m

Uponor Multi kile

- PE-kile. Paigaldatakse soojusisolatsiooni peale
- läbipaistev

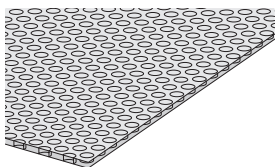

Art. nr.	Dimension	s mm	G kN/m ²	ND	L m	B	A	pakend	UOM
1000017	4mm 60x1m	4,0	15	4	60	1	60	60	m ²

Uponor Multi ääreriba kilega

- Ääreriba, vast. DIN 18560. Materjal polüetüleen. Välisküljel olev kleepriba tagab ääreriba ja isolatsiooni vahelise ühenduse

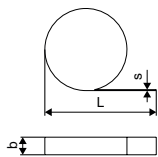

Art. nr.	Dimension	l mm	L m	s mm	b mm	värvus	pakend	UOM
1000079	150x8mm	50000	50	8	150	sinine	200	m

Uponor Multi kaitsehülss

- Materjal PE-LD, külglõhega. Kuni 20 mm PK torude kaitseks paisumisvuukides

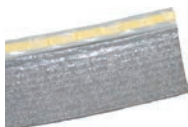

Art. nr.	Dimension	s mm	l mm	b mm	pakend	UOM
1000082	max 20mm 300x5mm	5,0	300	80	30	tk

Uponor Multi

Uponor Multi betoonilisand

- betoonilisand; parandab segu kvaliteeti
- ainult tsementsegudele
- suurendab platilisust ja vee peetust
- materjali kulu 7 cm segukihile: 0.2 l/m²
- minimaalne katva segukihi paksus: 30 mm koormusel 2 kN/m² või 45 mm koormusel 5 kN/m²
- kõvastumisaeg: 21 päeva



Art. nr.	Dimension	Vol. l	KA d	2. pak.	pakend	UOM
1000084	VD 450 20L	20,00	21	480	20	l

Uponor Vario M

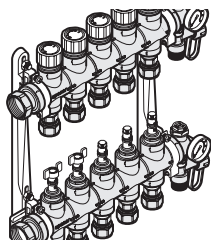

Uponor Vario M on kõrgekvaliteediline plastkollektor. Kasutatakse põrandakütte ja -jahutussüsteemides. Väljundid G 3/4 eurokoonus sobivad kõikide Uponor põrandaküttetorude ühendamiseks.

Eelised

- Paigaldusvalmis – eelkoostatud kollektorid 2-15 küttekontuurile
- Lihtne paigaldada – peale- ja tagasivoolumoodulid teineteise suhtes nihutatud
- Määrdukiskindlad vooluhulgaregulaatorid; vahetatavate klaasidega
- Sobivad ka suurtele kütte- ja jahutuspindadele elu- ja ärihoonetes
- Pumbasõlmede ja soojamõõtjate ühendamise võimalus



Kirjeldus

- Lattkollektor
- Integreeritud ventiilidega
- Parem- või vasakpoolse ühendusega 1" (lametihend)
- Pealevoolul vooluhulga regulaatorid tasakaalustamiseks ja sulgemiseks
- Tagasivoolul korkidega varustatud ventiil
- Öhueraldus-, täite- ja tühjendusventiilid
- Küttekontuuri ühendus: G3/4" eurokoonus
- Väljundite samm: 50 mm
- Materjal: klaasfiibriga armeeritud polüamiid

Kasutusala

- Põrandaküttele ja -jahutusele
- Max. rõhk: 6 bar, 60°C
- Sobilikud ajamid:
 - 1087778 (24V)
 - 1087763 (230V)

Uponor Vario M kollektor vooluh reg FM

Uponor Vario M kollektor vooluhulga regulaatoriga FM



Art. nr.	Dimension	väljundid p - bar	l mm	pakend	UOM
1085944	2X G3/4 Euro	2	6 210	1	tk
1085945	3X G3/4 Euro	3	6 260	1	tk
1085946	4X G3/4 Euro	4	6 310	1	tk
1085947	5X G3/4 Euro	5	6 360	1	tk
1085948	6X G3/4 Euro	6	6 410	1	tk
1085949	7X G3/4 Euro	7	6 460	1	tk
1085950	8X G3/4 Euro	8	6 510	1	tk
1085951	9X G3/4 Euro	9	6 560	1	tk
1085952	10X G3/4 Euro	10	6 610	1	tk
1086250	11X G3/4 Euro	11	6 700	1	tk
1086251	12X G3/4 Euro	12	6 750	1	tk

Uponor SPI Vario M vooluhulga regulaator

varuosas Vario M kollektorile



Art. nr.	Dimension	pakend	UOM
1085956*	0-5l/min	1	tk

Uponor Vario S

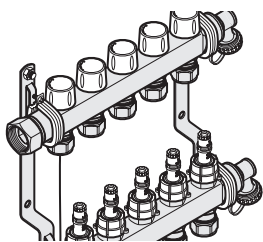

Uponor Smart S on roostevabast terasest põrandkütte kollektor nii elu- kui tööstuslikesse ruumidesse.

Väljundid G 3/4 eurokoonus.

Sobib kõikide Uponor põrandaküttetorudega.

Eelised

- Paigaldusvalmis – eelkoostatud kollektorid 2-15 küttekontuurile
- Lihtne paigaldada – peale- ja tagasivoolu moodulid teineteise suhtes nihutatud
- Määrumiskindlad vooluhulga regulaatorid vahetatavate klaasidega
- Sobivad ka suurtele kütte- ja jahutuspiindadele elu- ja ärihoonetes
- Pumbasõlmede ja soojamõõtjate ühendamise võimalus



Kirjeldus

- Roostevabast terasest
- Integreeritud ventiilidega
- Pealevoolu parem- või vasakpoolne ühendus
- Integreeritud õhueraldid, täite- ja tühjendusotsad peale- ja tagasivoolul
- Küttekontuuride ühendus G3/4" eurokoonus
- Ühendusotste samm 50 mm
- Telgede vahe 200 mm

Kasutusala

- Põrandaküttele ja -jahutusele
- Sobivus ajamitega:
- 1087778 (24V)
- 1087763 (230V)
- Max. rõhk: 6 bar, 60°C

Uponor Vario S kollektor FM

- Vooluhulga regulaatoritega tasakaalustamiseks ja sulgemiseks
- Tagasivoolu klappidel korgid

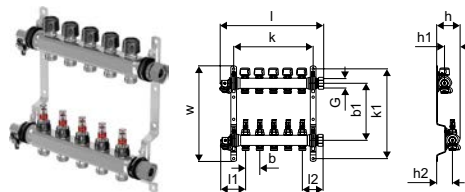

Art. nr.	Dimension	l	l1	l2	G	G1	b	b1	b2	h	h1	h2	k	k1	w	väljundid	p	bar	uPoints	2. pak.	pakend	UOM
1086538	2X3/4 Euro	210	87	73	1	3/4	50	215	215	75	30	50	135	336	357	2	6	100	1	tk		
1086539	3x3/4 Euro	260	87	73	1	3/4	50	215	215	75	30	50	185	336	357	3	6	120	1	tk		
1086540	4x3/4 Euro	310	87	73	1	3/4	50	215	215	75	30	50	235	336	357	4	6	140	1	tk		
1086541	5x3/4 Euro	360	87	73	1	3/4	50	215	215	75	30	50	285	336	357	5	6	160	1	tk		
1086542	6x3/4 Euro	410	87	73	1	3/4	50	215	215	75	30	50	335	336	357	6	6	180	1	tk		
1086543	7X3/4 Euro	460	87	73	1	3/4	50	215	215	75	30	50	385	336	357	7	6	210	1	tk		
1086544	8x3/4 Euro	510	87	73	1	3/4	50	215	215	75	30	50	435	336	357	8	6	230	1	tk		
1086545	9x3/4 Euro	560	87	73	1	3/4	50	215	215	75	30	50	485	336	357	9	6	250	1	tk		
1086546	10x3/4 Euro	610	87	73	1	3/4	50	215	215	75	30	50	535	336	357	10	6	270	48	1	tk	
1086547	11x3/4 Euro	660	87	73	1	3/4	50	215	215	75	30	50	585	336	357	11	6	300	48	1	tk	
1086548	12x3/4 Euro	710	87	73	1	3/4	50	215	215	75	30	50	635	336	357	12	6	320	48	1	tk	

Uponor SPI Vario Vario S vooluhulga regulaator

varuosa Vario S kollektorile



Art. nr.	l	b	pakend	UOM
1087608	100	ø24	10	tk

Uponor Vario

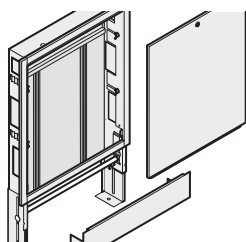

- kontrollereid
- soojusdõõtjaid
- ventile ja ühendustarvikuid

Uponor Vario kollektorkapid on osa põrandaküttesüsteemist.

Võimaldavad paigaldada kõiki vajalikke süsteemi

komponente:

- kollektoreid
- pumbasõlmi

Eelised

- Uponor kollektorite ja komponentide (pumbasõlmed, automaatika jne...) paigaldamiseks
- Reguleeritav kappide kõrgus ja sügavus
- Uks ja raam eraldi pakendis, tolmuindel
- Reguleeritavad paigaldussiinid
- Kollektorite vertikaalne või horisontaalne ühendus
- Vaba ala juhtseadmetele (kollektori kohal)
- Jalgade reguleerimise võimalus vastavalt põranda konstruktsioonile



Uponor Vario kollektori kapp IW

- **Seinasisene** komplektne kapp raami ja uksega
- Sügavus: 110mm, suurendatav kuni 150mm
- Reguleeritav kõrgus: 730 - 930mm
- Ukse konstruktsiooni kõrgus: maks. 200mm
- Materjal: tsingitud teras
- Raam ja uks pulbervärvitud, valge (RAL 9010)
- Lukustatav uks

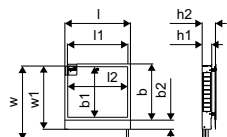

NEW
NEW
NEW
NEW

Art. nr.	Dimension	l mm	l1 mm	l2 mm	b mm	b1 mm	b2 mm	h1 mm	h2 mm	w mm	w1 mm	2. pak.	pakend	UOM
1093473	550x730x110mm	605	550	539	650	572	108	110	150	930	730	27	1	tk
1093474	700x730x110mm	755	700	689	650	572	108	110	150	930	730	20	1	tk
1093475	850x730x110mm	905	850	839	650	572	108	110	150	930	730	18	1	tk
1093476	1000x730x110mm	1055	1000	989	650	572	108	110	150	930	730	13	1	tk

Uponor SPI Vario silindr. lukk, 2 võtit

- Vario kappidele
- Metall, nikeldatud



NEW

Art. nr.	pakend	UOM
1093554	1	tk

Uponor Vario

Uponor Vario seinapealne kapp NT

- Seinapealne kollektorkapp
- Tsingitud teras
- Valge
- Lukustatav

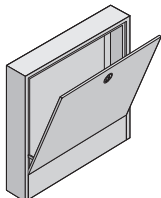

Art. nr.	Dimension	l mm	l1 mm	b mm	h mm	w mm	värvus -	2. pak.	pakend	UOM
1046996	555x160mm	555	504	618	160	810	RAL 9010		1	tk
1046997	705x160mm	705	654	618	160	810	RAL 9010	10	1	tk
1046998	785x160mm	785	734	618	160	810	RAL 9010		1	tk
1046999	950x160mm	950	898	618	160	810	RAL 9010		1	tk

Uponor Vario seadeventiilid

- Kollektorite tasakaalustamiseks ja sulgemiseks
- Tsooni juhtimiseks Uponor M30x1.5mm VK ajamiga
- Korpus - messing
- Käepidemed - polüamiid
- Maksimaalne katserõhk: 10 bar (vesi)

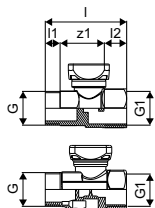

Art. nr.	Dimension	l mm	l1 mm	l2 mm	G "	G1 "	z mm	2. pak.	pakend	UOM
1005100	G1 - Rp1	80	15	22	1	1	44	10	1	kompl.

Uponor Vario kuulkraan

- Nikeldatud messing
- Kollektori sulgemiseks



Art. nr.	Dimension	AG	IG	2. pak.	pakend	UOM
1059132	NP G1-G1	1	1	10	1	kompl.

Uponor Vario

Uponor Vario SM ühendus G1

- Nikeldatud messing
- Kollektori horisontaalseks ühendamiseks G1
- Andurite ühendused M10x1 peale- ja tagasivoolul



Art. nr.	Dimension	G	G1	l	l1	l2	h	h1	z	z	pakend	UOM
		"	"	mm	mm	mm	mm	mm	mm	mm		
1090728	G1" 130mm	1	1	-	315	80	42	36	300	65	1	kompl.

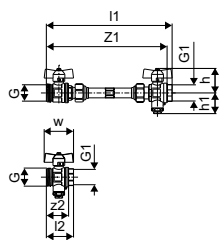

Uponor Vario SM ühendus G1

- Nikeldatud messing
- Kollektori vertikaalseks ühendamiseks
- Andurite ühendused M10x1 peale- ja tagasivoolul



Art. nr.	Dimension	G	G1	l	l1	l2	h	h1	z	pakend	UOM
		"	"	mm	mm	mm	mm	mm	mm		
1090729	G1" 130mm	1	1	325	160	110	-	280	265	1	kompl.

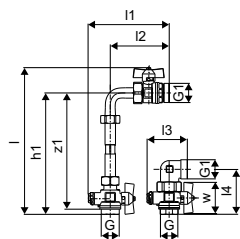

Uponor Vario

Uponor Vario SM ühendus G3/4

- Nikeldatud messing
- Kollektorite horisontaalseks ühendamiseks G 3/4"
- Andurite ühendused M10x1 peale- ja tagasivoolul



Art. nr.	Dimension	G	G1	I1	I2	h	h1	z	z2	pakend	UOM
		"	"	mm	mm	mm	mm	mm	mm		
1090730	G3/4" 110mm	1	3/4	265	70	42	36	250	55	1	kompl.

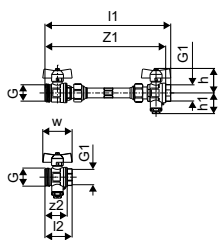

Uponor Vario SM ühendus G3/4

- Nikeldatud messing
- Kollektorite vertikaalseks ühendamiseks G 3/4"
- Andurite ühendused M10x1 peale- ja tagasivoolul



Art. nr.	Dimension	G	G1	I	I1	I2	h1	z	pakend	UOM
		"	"	mm	mm	mm	mm	mm		
1090731	G3/4" 110mm	1	3/4	285	150	110	240	225	1	kompl.

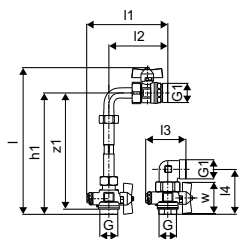

Uponor Smatrix Move PRO

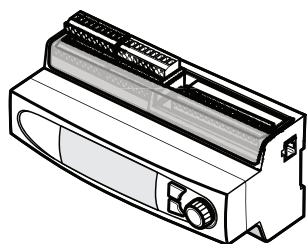

Paindlik ja mitmekülgne **mitme tsooni pealevoolu-temperatuuri juhtimisautomaatika**.

Erinevate sise- ja välisrakenduste juhtimine (kiirgusküte, -jahutus, soe tarbevesi) ühe kontrolleri abil.

Olenevalt tarkvarast (SD kaart) võimaldab töötada kütte või kütte ja jahutuse süsteemides.

Ühildub Smatrix Base PRO süsteemiga.

Integreeritav hoone keskujuhtimise süsteemiga (KNX moodul)

Eelised

- Mitmeotstarbeline pealevoolutemperatuuri kontroller
- Juhib kuni 4 pealevoolukontuuri üheaegselt
- Automaatne kütte/ jahutuse ümberlülitus
- Kompensatsiooniviiside valik
- Jää ja lume ning pinnase sulatussüsteemide juhtimine

Uponor Smatrix Move PRO kontrolleri X-159

- Mitme tsooni pealevoolutemperatuuri kontrolleri
- Sisekliima juhtimiseks ärihoonetes
- Kiirgusküte ja jahutus
- Soe tarbevesi

Funktsioonid:

- Kütte, jahutus ja soe tarbevesi
- Kuni 4 küttesooni või 3 küttesooni ja 1 jahutustsoon
- Kuni 2 lumesulatustsooni
- Eraldi töötamiseks (juhtmetega anduritega) või integreerituna Smatrix Base PRO süsteemiga
- Integreeritav BMS süsteemiga ModBus või KNX liidese abil
- Lihtne paigaldada ja konfigureerida
- Mikro SD kaart tarkvara uuenduseks ja seadete kloonimiseks

Komplektis:

- Uponor Smatrix Move PRO kontrolleri X-159
- Kütte rakenduse pakett (mikro SD kaart, kleebised, juhendid)
- Kütte ja jahutuse rakenduse pakett (mikro SD kaart, kleebised, juhendid)
- Kiirpaigaldusjuhendid

- Lisavastavus: EAC
- Ühendusprotokoll: Modbus-RTU (alluv), Uponor Smatrix Base PRO bus
- Toitepinge: 230V 50Hz / 125mA
- Töötemperatuur: 0°C ... +50°C
- Kaitseklass: IP20
- ERP klass: III (1.5%) / VII (3.5%) ruumitermostaadiga



Art. nr.	TP V	l mm	b mm	d mm	uPoints	2. pak.	pakend	UOM
1087155*	230	213,5	93,3	90	 400	10	1	tk

Uponor Smatrix Move PRO

Uponor Smatrix Move PRO sulatuskomplekt S-152 + S-158

- Sulatuskütte komplekt Uponor Smatrix Move PRO kontrolleri X-159
- Juhib 0-10V modulaarjuhtimisega 3-tee ventiili või 2-tee ventiili
- 3 töörežiimi: stop, sulatus, meltaway
- 1 kaitserežiim: soojusvaheti kaitse

Komplektis:

- 3x Uponor Smatrix Move peale- ja tagasivoolu andurit S-152
- 2x Uponor Smatrix Move PRO lume&jää andurit S-158 (pinnase andur koos vutlariga)
- Kiirjuhend koos ühendusskeemidega.
- Vastavus: EAC



Art. nr.	d mm	L m	h mm	uPoints	2. pak.	pakend	UOM
1087158*				400		1	kompl.
1087156	63	25	78	100	5	1	tk

Uponor Smatrix Move PRO temp. andur S-155

- Ruumitemperatuuriandur
- Sisetsoonide kütte ja jahutuse juhtimiseks välistemperatuuri muutuse kompensatsiooniga
- 2-juhtmeline ühendus Uponor Smatrix Move PRO kontrolleri X-159

- Vastavus: EAC
- Anduri tüüp: NTC10
- Temperatuurivahemik: 0°C ... +60°C
- Kaitseklass: IP20



Art. nr.	TP V	l mm	b mm	d mm	uPoints	2. pak.	pakend	UOM
1087159*	24	80	85	30	100	10	1	tk

Uponor Smatrix Move PRO niiskuseandur S-157

- Ruumi temperatuuriandur niiskuseanduriga
- Mõõdab suhtelist niiskust kondensatsiooni vältimiseks
- Ainult jahutuse või kütte ja jahutuse tsoonidele
- 3-sooneline ühendus Uponor Smatrix Move PRO kontrolleri X-159.
- Vastavus: EAC
- Niiskuse mõõtevahemik: 0-100%
- Täpsus: <2%RH
- Toitepinge: 24V / 50-60 Hz
- Töötemperatuur: -10°C ... +50°C
- Kaitseklass: IP20



Art. nr.	TP V	l mm	b mm	d mm	uPoints	pakend	UOM
1087160*	24	80	85	30	100	1	tk

Uponor Smatrix Move PRO

Uponor Smatrix Move PRO kond. komplekt S-159

- Kondensatsiooni komplekt
- Kaitseb kiirgusjahutussüsteeme kondensatsiooni eest
- Peatab ajutiselt jahutuse toimimise, kui kondensaadi tekkimise oht on suur
- Ühendatakse Uponor Smatrix Move PRO kontrolloriga X-159
- 24V, IP20

Komplektis:

- Torule paigaldatav niiskuse andur
- Konverter
- Lühijuhend koos ühenduskeemidega



Art. nr.	TP	I	b	d	uPoints	2. pak.	pakend	UOM
	V	mm	mm	mm				
1087165*	24	85	60	36	 100	10	1	kompl.

Uponor Smatrix Move

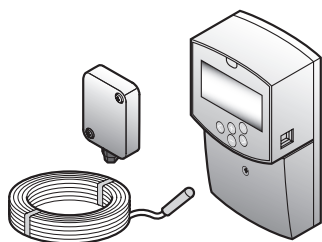

Pealevoolutemperatuuri juhtimine küttesüsteemides. Seadistab pealevoolu temperatuuri vastavalt sise- ja välistemperatuurile.

Eelised

- Komfort ja Eco programmeeritud graafikud
- Olekuinfo reaalajas
- Pumba loogika nii iseseisvaks tööks kui ka kombineerituna Uponor ruumi automaatikaga
- Lisavõimalus: sekundaarkütte/sooja tarbevee kontuuri juhtimine



Kirjeldus

- Komfort ja Eco programmeeritud graafikud
- Olekuinfo reaalajas
- Pumba loogika nii iseseisvaks toimimiseks või koos Uponor ruumi automaatikaga
- Erinevad kompensatsiooni võimalused
- Lisavõimalus: sekundaar kütte/sooja tarbevee juhtimine
- Lisavõimalus: sulatuskütte lisamine
- Lisavõimalus: kondensatsiooni kaitse

Kasutusala

- pealevoolu vee temperatuuri juhtimine

Sertifitseerimine

- CE

Uponor Smatrix Move kontrolleri H X-157 juhtmega

- **Pealevoolu temperatuuri kontrolleri**
- Juhtimisrežiim: ainult kütte, välistemperatuuri järgi

Funktsioonid:

- Segamisventiili juhtimine
- 9 eelprogrammeeritud graafikut (nädala programm)
- 4 vabalt programmeeritavat graafikut, autonoomse pumba loogika
- Autonoomse pumba loogika
- Uponor Smatrix Base või Wave kontrolleri koos töötava pumba loogika
- Pealevoolu-, sise- ja välistemperatuuri info reaalajas
- Segamisventiili oleku info reaalajas
- Jooksva päeva graafiline info (komfort ja alandatud temperatuur) reaalajas
- Sooja tarbevee valmistamine ja boileri juhtimine
- Kuumaveeringlus
- Pealevoolu temperatuuri reguleerimine kuni 100°C
- 2 pingestatud üldotstarbelist väljundit, 2 üldotstarbelist sisendit
- Turvakontaktiga termostaat, 230V segamismootor

Komplektis:

- Uponor Smatrix Move kontrolleri
- Peale-/tagasivoolu andur
- Välisandur

- Kaitseklass: IP30 II
- Värvus: tumehall



Art. nr.	l mm	b mm	d mm	2. pak.	pakend UOM
1071693	160	86	53	4	1 kompl.

Uponor Smatrix Move

Uponor SPI Smatrix Move PLUS antenn A-155 Radio

- varuantenn Uponor Smatrix Move kontrolleri
- tagab juhtmevaba ühenduse Uponor Smatrix Wave termostaatidega

Komplektis:

- Uponor Smatrix Move antenn
- ühenduskaabel
- paigaldustarvikud

- vastavus: EAC



Art. nr.	Frequency MHz	l mm	b mm	d mm	2. pak.	pakend	UOM
1071676*	868	200	23	15	21	1	tk

Uponor Smatrix Move pealev/tagasiv andur S-152

- Peale-/tagasivoolu andur
- Mõõdab peale- või tagasivoolu temperatuuri
- Anduri tüüp: NTC 10 kΩ, 25 °C
- Kaabli pikkus: 3m
- Kaitseklass: IP68 II



Art. nr.	L m	pakend	UOM
1071661	3	1	tk

Uponor SPI Fluvia Move PLUS ajam 230V

- Ajam 230V
- 3- punkti juhtimine



Art. nr.	TP V	2. pak.	pakend	UOM
1084560	230	16	1	tk

Uponor Smatrix väliandur S-1XX

- mõõdab välistemperatuuri
- komplektis paigaldustarvikud
- kasutatakse koos Uponor Smatrix Wave/Move kontrolleri
- lisavõimalus juhtmevaba ühendus koos Uponor Smatrix Wave termostaadiga Public
- kaitseklass: IP55
- anduri tüüp: NTC 10kOhm, 25°C
- värvus: helehall



Art. nr.	2. pak.	pakend	UOM
1071671*	45	1	tk

Uponor Fluvia Move/Move PLUS

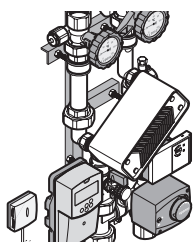

Uponor Fluvia Move eelkoostatud pumbasõlmed tagavad soovitud pealevoolu ja ringluse kiirgusküttesüsteemides.

Fluvia Move pumbasõlmed sisaldavad kõiki vajalikke ühenduskomponente.

Eelised

- Komplektne eelkoostatud sõlm
- Sisaldavad kõiki vajalikke komponente
- Pealevoolutemperatuuri juhtimine Uponor Smatrix Move kontrolloriga
- Kinnitusklambrid seinale või Uponor kollektorkappi paigaldamiseks
- Lihtne menüü



Kirjeldus

- Uponor Smatrix Move automaatikaga komplekteeritud pumbasõlm
- Välistemperatuuri anduriga (paigaldatakse kohapeal)
- Pealevoolu vee temperatuuri andur
- Ajamiga juhtiv 3-tee seguventiil
- Proportsionaalne rõhu reguleerimine
- Kütte/ jahutuse juhtimise laiendamise võimalus
- Uponor Smatrix termostaadiga T-168 (1086984) ja Uponor Smatrix antenniga (1071676)

Kasutusala

- Välistemperatuurist sõltuv pealevoolu vee temperatuuri juhtimine
- Max. primaartemperatuur 90°C
- Max. sekundaarrõhk: 6 bar, 60°C

Uponor Fluvia Move pumbasõlm MPG-10-A-W

- Pump WILO Yonos Para 15/6: Q: 0,1-2,5 m³/h, H: 6-2,4 m, EEI 0,17
- Kuulkraan + pealevoolu tasakaalustusventiil
- Väljuvad ühendused G1 (VK)
- Parem- või vasakukäeline ühendus kollektoriga



OUT

Art. nr.	Flow Rate l/h	kvs m³/h	TP V	P W	p bar	uPoints	2. pak.	pakend	UOM
1078306*	0,1-2,5	4,3	230	45	6	2800	30	1	tk

Uponor Fluvia Move/Move PLUS

Uponor Fluvia pumbasõlm MPG-10-B-W

- 3T-ventiiliga
- Vajab lisaks ajamit ja automaatikaplokki
- Pump (WILO Yonos Para 15/6): Q: 0,1-2,5 m³/h, H: 6-2,4 m, EEI 0,17
- Kuulkraan + pealevoolu tasakaalustusventiil
- Väljuvad ühendused G1 (VK)
- Parem- või vasakukäeline ühendus kollektoriga



Art. nr.	Flow Rate l/h	kvs m³/h	TP V	P W	p bar	uPoints	2. pak.	pakend	UOM
OUT 1078307*	0,1-2,5	4,3	230	45	6	1100	30	1	tk

Uponor Fluvia Move pumbasõlm CPG-15-A-W

- Eraldiseisev pumbasõlm automaatikaga
- Pump (WILO Yonos Para 25/6): Q: 0,1-2,5 m³/h, H: 6-2,4 m, EEI 0,17
- Kuulkraan + pealevoolu tasakaalustusventiil
- Väljuvad ühendused G1 (VK)
- Parem- või vasakukäeline ühendus kollektoriga



Art. nr.	Flow Rate l/h	kvs m³/h	TP V	P W	p bar	uPoints	2. pak.	pakend	UOM
OUT 1078308*	0,1-2,5	6,3	230	45	6	3200	18	1	tk

Uponor Fluvia pumbasõlm CPG-15-B-W

- Eraldiseisev pumbasõlm automaatikaga
- Vajab lisaks ajamit ja automaatikaplokki
- Pump (WILO Yonos Para 25/6): Q: 0,1-2,5 m³/h, H: 6-2,4 m, EEI 0,17
- Kuulkraan + pealevoolu tasakaalustusventiil
- Väljuvad ühendused G1 (VK)
- Parem- või vasakukäeline ühendus kollektoriga



Art. nr.	Flow Rate l/h	kvs m³/h	TP V	P W	p bar	uPoints	2. pak.	pakend	UOM
OUT 1078309	0,1-2,5	6,3	230	45	6	1450	18	1	tk

Uponor Fluvia Move/Move PLUS

Uponor Smatrix Move 3-punkti segamismootor 230V

- 230V segamismootor
- 3-punkti juhtimine
- Uponor Smatrix Move kontrolleri



Art. nr.	TP V	pakend UOM	
1002357	230	1	tk

Uponor Move PLUS soojusvahetiga pumbasõlm

Kirjeldus

- Pump: Q: 0,1-2,5 m³/h, H: 6-2,4 m, EEI 0,17
- Soojusvahetiga
- Primaarühendus Rp1 1/4 (SK)
- Sekundaarühendused kuulkraanid lametihendiga G1 (SK)

Kasutusala

- Maakütte kollektori hüdrauliliseks eraldamiseks
- Vabajahutseks
- Max primaarpoole temperatuur 90°C
- Max sekundaarpoole rõhk: 6 bar, 60°C

Uponor Fluvia Move PLUS pumbasõlm EPG-6-A-W

- Soojusvahetiga
- Vajalikud automaatika tarvikud:
- Uponor Smatrix termostaat T-168
- Uponor Smatrix antenn (1071676)



Art. nr.	Flow Rate l/h	kvs m ³ /h	TP V	P W	p bar	Q kW	2. pak.	pakend UOM	
1078310	0,1-2,5	7	230	45	6	1-6	8	1	tk

Uponor Fluvia T

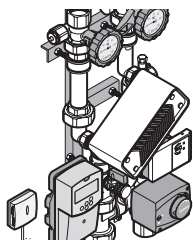

Fluvia T pumbagrupid sisaldavad kõiki toimimiseks vajalikke komponente. Konstantse pealevoolutemperatuuri tagamiseks. (Kuni 2 kontuuri)

Eelised

- Eelkoostatud pumbagrupid: hüdrauliliselt katsetatud
- Sisaldavad kõiki vajalikke komponente
- Pealevoolutemperatuuri juhtimine termostaatpea või ajamiga
- Kinnitusklambrid paigaldamiseks seinale või kollektorikappi



Kirjeldus

- Integreeritud Grundfos pump: Q: 0,1 - 0,4 m³/h, H: 0,2 - 1,1 m, Phyd< 1W
- Parem- või vasakukäeline paigaldus
- Õhueraldajaga
- Sekundaarpoole temperatuurivahemik 20-50°C
- Tasakaalustusventiil
- Küttekontuuri ühendus 3/4" eurokoonusega
- Primaarpoole ühendus surveliitmikud 15 mm vasktorule

Kasutusala

- Põrandakütte juhtimiseks väikestes tsoonides
- Max. primaartemperatuur 90°C
- Max. rõhk: 6 bar, 60°C

Uponor Fluvia T Push-12 TH-G

- Kapillaartermostaadiga pumbagrupp 12-28°C
- Maksimaalse pealevoolutemperatuuri piirajaga 50°C



NEW

Art. nr.	l	l1	l2	G	G1	b	b1	b2	h	h1	w	2. pak.	pakend	UOM
	mm	mm	mm	"	"	mm	mm	mm	mm	mm	mm			
1095127	332	38	129	5/8	3/4	40	65	65	84	42	240	60	1	tk

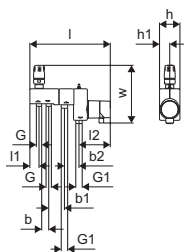

Uponor Fluvia T

Uponor Fluvia T pumbagrupp Push-12 AC-G

- **Ajamiga 230V** pumbagrupp(saab käskluse väliselt automaatselt või termostaadilt)
- Maksimaalse pealevoolutemperatuuri piiraja 50°C



NEW

Art. nr.	2. pak.	pakend	UOM
1095128	60	1	tk

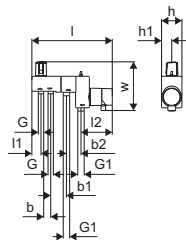

Uponor Fluvia toruhargmik

- Messing
- PUSH-12 pumbasõlme laiendamiseks 2 kütteringile



Art. nr.	Dimension	l mm	l c mm	2. pak.	pakend	UOM
1005675	2xG3/4-3/4" Euro	50	40	50	1	kompl.

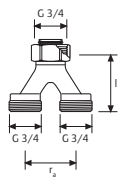

Uponor Fluvia T

Uponor Fluvia T pumbagrupp PUSH

Kirjeldus

- Pump WILO Yonos Para 15/6 RKA: Q: 0,1-2,5 m³/h, H: 6-2,4 m EEI 0,17
- Kapillaaranduriga termostaat 20-55°C
- G1 (VK) ühendamiseks Uponor põrandakütte kollektoritega

Kasutusala

- Ühendamiseks Uponor kollektoritega, paigaldus seinale või kollektorkappi
- max primaartemperatuur 90° C
- max sekundaartemperatuur 55° C
- max 6 bar

Uponor Fluvia T pumbasõlm Push-23-B-W mitme kontuuriga põrandakütte

- Maksimaalne võimus: **10 kW**
- kvs arv: 1,2 m³/h
- pealevoolu kontrollitakse **kapillaarsensoriga termostaadiga** (konstantne pealevoolutemperatuur)
- ühendus otse kollektori külge



OUT

Art. nr.	Flow Rate	kvs	TP	P	p	Q	uPoints	pakend	UOM
	l/h	m ³ /h	V	W	bar	kW			
1078304	0,1-2,5	supply 1,2 / return 2,7	230	45	6	10	900	1	tk

Uponor Fluvia T

Uponor Smart pumbagrupp

Kirjeldus

- Termostaatventiili ja kapillaartermostaadiga 20-55°C
- Toiteühendused Rp 3/4
- Põrandkütte ühendused G1, lametihendiga
- Seadeventiil

Kasutusala

- Konstantse pealevoolu temperatuuri juhtimisega
- Max pealevoolu temperatuur 90°C
- Max põrandkütte rõhk: 6 bar, 50°C

Uponor Smart pumbasõlm mitme kontuuriga põrandaküttele ca 10 kw

- Pump Q: 0,1-2,4 m³/h, H: 4 m EEI ≤0,2
- Pumbasõlm ühendamiseks kollektoriga.
- **Omatoimeline kapillaartermostaat (20-55°C) konstantse pealevoolu temperatuuri seadmiseks.**
- Pealevoolu termostaatventiil kvs 1,2 m³/h
- Tagasivoolu tasakaalustusventiil kvs 2,7 m³/h
- ühendus kollektoriga G1 (vk)
- lametihendiga ühendused G1-G1 kuulkraanide ühendamiseks.
- max sekundaartemperatuur 55°
- max rõhk 6 bar



OUT

Art. nr.

1086563

uPoints

2. pak.

pakend UOM



500

45

1

tk

Uponor pumbasõlmede varuosad

Uponor SPI Fluvia T Grundfos pump Push-12

- Uponor Fluvia T pumbagrupidete PUSH-12 AC-G / WL-G / TH-G / CH-G



NEW

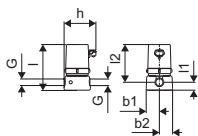

Art. nr.	2. pak.	pakend	UOM
1095132	20	1	tk

Uponor SPI Fluvia Wilo Yonos Para pump

varuosa PUSH 23 pumbagrupidete



Art. nr.	Dimension	TP V	pakend	UOM
1059854	RS15/6 G1 130mm	230	1	tk

Uponor SPI Fluvia T Push 23 termostaat Push-23

varuosa Push-23 Push-23-C pumbagrupidete



Art. nr.	pakend	UOM
1063461	1	tk

Uponor Smatrix Wave

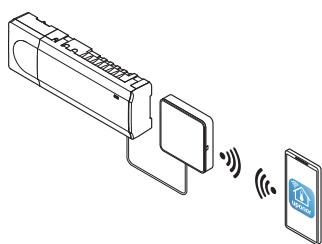

Smatrix automaatikasüsteem võimaldab nii automaatset tasakaalustust kui ka muid energiasäästu tagavaid võimalusi kiirguskütte- ja jahutussüsteemides. Süsteemi saab kaugjuhtida Smatrix rakenduse abil.

Eelised

- Kaugjuurdepääs Smatrix rakenduse abil
- Automaatne kütteringide tasakaalustamine
- Kiire paigaldus, minimaalne kaabeldus
- Lihtne seadistada
- Lai valik võimalusi energia efektiivseks kasutamiseks



Kirjeldus

■ juhtmevabadele termostaatidele

- kuni 4 kontrollerit juhitavad ühe ühendusmooduliga R-208
- automaatne tasakaalustus optimeerib energiakasutust ja mugavust
- ühe kontrolleriga on võimalik ühendada kuni 6 ruumi termostaati ja 8 ajamit (24V)
- pumba ja katla lülitusreleed
- ajamite ja pumba sundkäivitus
- by-pass möödaviik
- suhtelise niiskuse kontrollimine
- põrandakütte/-jahutuse ja lagijahutuse juhtimisvõimalus
- kontrolleri toitepinge 230V
- ajamite toitepinge 24VAC
- ajami võimsus: 0.2A (0.4A käivitusel)
- andmete säilitamine pilves, tarkvara uuendused interneti teel
- lokaalne (Wi-Fi) või kaugjuurdepääs (vajalik interneti ühendus) ühendusmooduli R-208 ja Smatrix äpi kaudu
- ajutine wi-fi ühenduspunkt juurdepääsuks (kui kohalik wi-fi ei ole saadaval) (R-208)
- nutikodu ökosüsteemi integratsioon (Amazon Alexa, Google Home) (R-208)
- mitme erineva paigalduse (hoone) juhtimine (R-208)
- kolmanda osapoole juurdepääs kaugtoeks (R-208)
- varasemate perioodide trendide analüüs Uponor Smatrix Pulse rakenduse abil (R-208)
- taimeri programmeerimine (R-208)
- mugavusseadistused (R-208)
- pealevoolu diagnostika (R-208)

Kasutusala

- kiirguskütte ja jahutuse juhtmevaba ruumi temperatuuri juhtimine
- termostaatide seadevahemik: +5°C ... +35°C

Sertifitseerimine

- CE / EAC

Uponor Smatrix Wave

Uponor Smatrix Wave stardipakett Pulse S

- juhtmevabad termostaadid
- kasutusvalmis hooldevaba pörandakütteautomaatika stardipakett
- laiendatav vastavalt vajadusele
- kaitseklass: II IP20
- värvus: valge

Komplektis:

- 1x Uponor Smatrix Pulse ühendusmoodul com R-208
- 1x Uponor Smatrix Wave kontrolleri Pulse X-265 6X
- 3x Uponor Smatrix Wave termostaati D+RH Style T-169
- esmapaigalduse juhend, ohutusjuhendid
- paigaldustarvikud

Art. nr.	TP V	Frequency MHz	uPoints	2. pak.	pakend	UOM
1093284	230	868	700	3	1	kompl.



Uponor Smatrix Wave stardipakett Pulse L

- juhtmevabad termostaadid
- kasutusvalmis hooldevaba pörandakütteautomaatika stardipakett
- laiendatav vastavalt vajadusele
- kaitseklass: II IP20
- värvus: valge

Komplektis:

- 1x Uponor Smatrix Pulse ühendusmoodul com R-208
- 2x Uponor Smatrix Wave kontrolleri Pulse X-265 6X
- 5x Uponor Smatrix Wave termostaat D+RH Style T-169
- esmapaigalduse juhend, ohutusjuhendid
- paigaldustarvikud

Art. nr.	TP V	Frequency MHz	uPoints	2. pak.	pakend	UOM
1093287	230	868	700	2	1	kompl.



Uponor Smatrix Wave

Uponor Smatrix Wave Pulse X-265+R-208 6X

- kasutusvalmis komplekt: kontrolleri ja ühendusmoodul R-208
- **juhtmevabadele termostaatidele**
- laiendatav
- kaitseklass: II IP20
- värvus: valge

Komplektis:

- 1x Uponor Smatrix Pulse com R-208
- 1x Uponor Smatrix Base kontrolleri Pulse X-265 6X
- esmapaigalduse juhend, ohutusjuhend
- paigaldustarvikud

NEW

Art. nr.	TP V	Frequency MHz	uPoints	2. pak.	pakend	UOM
1093024	230	868	700	3	1	kompl.



Uponor Smatrix Pulse com Pulse com R-208

- ühendusmoodul
- **sama moodul nii juhtmega kui ka juhtmevabadele kontrolleri/termostaatidele**
- loob ühenduse Uponor Smatrix Pulse süsteemi, Uponor Smatrix Pulse rakenduse ja Uponor pilve vahel

Ühilduvus:

- Uponor Smatrix Base kontrolleri Pulse X-245 Bus 6X
- Uponor Smatrix Wave kontrolleri Pulse X-265 6X

- toide: RJ45 kaabel Wave või Base kontrolleri
- võrguliides: 10/100 Mbps (RJ45)
- võrgu protokoll: Ethernet II
- kaitseklass: Class II IP20
- värvus: valge

Komplektis:

- Uponor Smatrix Pulse com R-208
- adapter DIN siinile paigaldamiseks
- RJ45 ühenduskaabel (2m)
- esmakäivitusjuhend, ohutusjuhised
- paigaldustarvikud

NEW

Art. nr.	Frequency MHz	l mm	b mm	d mm	uPoints	2. pak.	pakend	UOM
1093030	868	110	21	110	600	16	1	tk



Uponor Smatrix Wave

Uponor Smatrix Wave kontrolleri Pulse X-265 6X

- kontrolleri koos antenniga juhtmevabadele termostaatidele
- kaitseklass: Class II IP20
- värvus: valge

Komplektis:

- Uponor Smatrix Wave kontrolleri Pulse X-265 6X
- Uponor Smatrix Wave antenn Pulse A-265
- esmakäivitus juhend, ohutusjuhised
- paigaldustarvikud



Art. nr.	TP V	Frequency MHz	l mm	b mm	d mm	uPoints	2. pak.	pakend	UOM
NEW 1093021	230	868	340	110	55	300	4	1	tk

Uponor Smatrix Wave lisamoodul Pulse M-262 6X

- 6 kanaliga lisamoodul kontrolleri Uponor Smatrix Wave Pulse X-265 6X
- võimaldab lisada 6 termostaati ja ajamit
- click-ühendus
- kaitseklass: IP20
- värvus: valge



Art. nr.	l mm	b mm	d mm	2. pak.	pakend	UOM
NEW 1093133	141	110	55	16	1	tk

Uponor SPI Smatrix Wave antenn Pulse A-265

- varuantenn kontrolleri Uponor Smatrix Wave Pulse X-265 6X
- kaabli pikkus: 3m
- pistik: RJ45
- värvus: valge

Komplektis:

- Uponor SPI Smatrix Wave antenn Pulse A-265 (koos ühenduskaabliga)
- kinnitustarvikud



Art. nr.	Frequency MHz	l mm	b mm	d mm	2. pak.	pakend	UOM
NEW 1093028	868	30	110	9	16	1	tk

Uponor Smatrix Wave

Uponor Smatrix Wave releemoodul M-161

- kahe väljundiga vastuvõtja kontrolleriitele Uponor Smatrix Wave või Uponor Smatrix Wave Pulse
- 2 potentsiaalivaba või 230V 5A väljundit
- pump / kuivati režiim
- pump / K/J lülitusrežiim
- katel / jahuti režiim
- tegevusraadius: max. 30m
- kaitseklass: Class II IP30
- värvus: valge

Komplektis:

- Uponor Smatrix Wave releemoodul M-161 2X
- toide
- paigaldustarvikud



Art. nr.	Dimension	Frequency MHz	l mm	b mm	d mm	2. pak.	pakend	UOM
1071673	2X	868	50	107,35	27,50	16	1	tk

Uponor Smatrix Wave dig. termostaat + RH Style T-169

- juhtmevaba termostaat
- mõõdab ja kuvab tajutavat ruumi temperatuuri ja suhtelist niiskust
- värvus: valge RAL 9016

Funktsioonid:

- kütte või jahutuse vajaduse indikatsioon
- RH mõõtmine ja kuvamine
- comfort / ECO indikatsioon
- ECO seade muutmise
- K/J käsitsi ümberlülitus
- jahutuse võimaldamine (ruumipõhine)
- temperatuuri näit celsius või fahrenheit
- mõõtmisviisid: ruumi temperatuur (RT), ruumi temperatuur koos põranda max/min temperatuur (RFT), kaugandur (RS), välistemperatuuri andur (RO)
- patarei tühjenemise indikaator
- temperatuuri näidu kalibreerimine
- ühildub Smatrix Move kontrolleriiga H/C Radio X-158
- lisa: põranda-, kaug- või välistemperatuuri anduri ühendamise võimalus

Komplektis:

- Uponor Smatrix Wave termostaat D+RH Style T-169
- 1x CR2032 patarei
- paigaldustarvikud



Art. nr.	Frequency MHz	l mm	b mm	d mm	uPoints	pakend	UOM
1087816	868	80	80	9	100	1	tk

Uponor Smatrix Wave

Uponor Smatrix Wave dig. termostaat + RH Style T-169

- juhtmevaba termostaat
- mõõdab ja kuvab tajutavat ruumi temperatuuri ja suhtelist niiskust
- värvus: must

Funktsioonid:

- kütte või jahutuse vajaduse indikatsioon
- RH mõõtmine ja kuvamine
- comfort / ECO indikatsioon
- ECO seade muutmine
- K/J käsitsi ümberlülitus
- jahutuse võimaldamine (ruumipõhine)
- temperatuuri näit celsius või fahrenheit
- mõõtmisviisid: ruumi temperatuur (RT), ruumi temperatuur koos põranda max/min temperatuur (RFT), kaugandur (RS), välistemperatuuri andur (RO)
- patarei tühjenemise indikaator
- temperatuuri näidu kalibreerimine
- ühildub Smatrix Move kontrolloriga H/C Radio X-158
- lisa: põranda-, kaug- või välistemperatuuri anduri ühendamise võimalus

Komplektis:

- Uponor Smatrix Wave termostaat D+RH Style T-169
- 1x CR2032 patarei
- paigaldustarvikud



Art. nr.	Dimension	Frequency MHz	l mm	b mm	d mm	uPoints	pakend	UOM
1087817	BLACK	868	80	80	9	100	1	tk

Uponor Smatrix Wave temp + RH andur Style T-161

- juhtmevaba termostaat/andur
- kasutamiseks avalikes ruumides
- temperatuuri seadistamine ainult koos ühendusmooduli ja äpi-ga
- Vaikimisi seade 21° C
- ruumi temperatuuri ja suhtelise niiskuse andur
- tegevusraadius: max. 30m
- kaitseklass: IP30
- värvus: valge RAL9016

Komplektis:

- Uponor Smatrix Wave ruumi andur+RH Style T-161
- 1x CR2032 patarei
- paigaldustarvikud



Art. nr.	Frequency MHz	l mm	b mm	d mm	uPoints	pakend	UOM
1087815	868	55	55	9	100	1	tk

Uponor Smatrix Wave

Uponor Smatrix Wave T-168

- juhtmevaba (programmeeritav) termostaat
- mõõdab ja kuvab tajutavat ruumi temperatuuri ja **suhtelist niiskust**
- värvus: läikiv valge

Funktsioonid:

- kütte või jahutuse vajaduse indikatsioon
- RH piiri indikatsioon
- individuaalne öine temperatuurialandus
- rakendusaja kuvamine
- 6 eelprogrammeeritud graafikut
- 1 vabalt programmeeritav graafik
- K/J käsitsi ümberlülitus (ainult koos Uponor Smatrix Move)
- jahutuse lubamine (ruumipõhine)
- temperatuuri näit celsius või fahrenheit
- mõõtmisviisid: ruumi temperatuur (RT), ruumi temperatuur koos põranda max/min temperatuuriga (RFT), kauganduriga (RS), välistemperatuuri anduriga (RO)
- taustavalgus (tumeneb 10 sek. peale viimast nupulevajatust)
- kuvab tarkvara versiooni (siselülitamisel)
- patarei tühjenemise indikaator
- ühildub Smatrix Move kontrolleri H/C Radio C-157
- lisa: põranda anduri ühendamise võimalus

Komplektis:

- Uponor Smatrix Wave termostaat prog.+RH T-168
- 2x AAA patareid
- paigaldustarvikud



Art. nr.	Dimension	Frequency MHz	l mm	b mm	d mm	uPoints	pakend	UOM
1086984	RAL9016	868	80	80	26,5	 100	1	tk

Uponor Smatrix Wave

Uponor Smatrix Wave T-166

■ juhtmevaba termostaat

- mõõdab ja kuvab tajutavat ruumi temperatuuri
- tegevusraadius: max. 30m
- kaitseklass: IP30
- värvus: läikiv valge

Funktsioonid:

- kütte või jahutuse vajaduse indikatsioon
- K/J käsitsi ümberlülitus (ainult koos Uponor Smatrix Move)
- jahutuse lubamine (ruumipõhine)
- temperatuuri näit celsius või fahrenheit
- mõõtmisviisid: ruumi temperatuur (RT), ruumi temperatuur kood pöranda temperatuuriga max/min (RFT), kauganduriga (RS), välistemperatuuri anduriga (RO)
- patarei tühjenemise indikaator
- režiimi muutmine taimer järgi
- öine temperatuurialandus
- taustavalgus (tumeneb 10 sekundit peale viimast nupulevajutust)
- kuvab tarkvara versiooni (siselülitamisel)
- ühildub Uponor Smatrix Move kontrolleri H/C Radio C-157
- lisa: pöranda anduri ühendamise võimalus

Komplektis:

- Uponor Smatrix Wave termostaat digital T-166
- 2x AAA patareid
- paigaldustarvikud



Art. nr.	Dimension	Frequency MHz	l mm	b mm	d mm	pakend	UOM
1086982	RAL9016	868	80	80	26,5	1	tk

Uponor Smatrix Wave T-165 POD

■ juhtmevaba termostaat

- mõõdab tajutavat ruumi temperatuuri
- kaitseklass: IP30
- värvus: läikiv valge

Funktsioonid:

- taustavalgus reguleeretta pööramisel
- kütte/jahutus-vajaduse indikatsioon
- lüliti taimer funktsiooni lubamiseks

Komplektis:

- Uponor Smatrix Wave termostaat standard T-165 POD
- 2x AAA patareid
- paigaldustarvikud



Art. nr.	Dimension	Frequency MHz	l mm	b mm	h mm	pakend	UOM
1086981	RAL9016	868	80	80	26,5	1	tk

Uponor Smatrix Wave

Uponor Smatrix Wave T-163

- „Public“ juhtmevaba termostaat ilma näidikuta
- Avalikesse ruumidesse
- tegevusraadius: max. 30m
- värvus: läikiv valge

Funktsioonid:

- potentsiomeeter temperatuuri seadmiseks kaane all
- avamisandur
- releekontakt sisend forsseeritud ECO režiimile läbi BMS
- releekontakt kütte/jahutuse ümberlülituseks
- mikrolülitid režiimide/andurite valikuks
- lisa: pöranda-, kaug- või välistemperatuuri anduri ühendamise võimalus

Komplektis:

- Uponor Smatrix Wave termostaat public T-163
- 2x AAA patareid
- paigaldustarvikud



Art. nr.	Dimension	Frequency MHz	l mm	b mm	d mm	pakend	UOM
1086979	RAL9016	868	80	80	26,5	1	tk

Uponor Smatrix Wave termostaatpea T-162

- digitaalne ajamiga radiaatori termostaatpea
- sobivus erinevate radiaatorventiilidega (Danfoss, Heimeier, Honeywell, Siemens, Sauter, jne.)
- värvus: läikiv valge

Funktsioonid:

- comfort/ECO seadistused
- programmeeritav nädalaks
- puhkuse režiim
- külmumiskaitse
- kiirendav funktsioon
- taustavalgus
- lisa: automaatne suve/talveaeg

Komplektis:

- Uponor Smatrix Wave termostaatpea T-162
- 2x AA patareid
- erinevad adapterid
- juhend



NEW

Art. nr.	Frequency MHz	l mm	b mm	d mm	uPoints	2. pak.	pakend	UOM
1071660	868	69	51	99	100	24	1	tk

Uponor Smatrix Wave

Uponor Smatrix alusraam T-X A-1XX

- Smatrix termostaatide alusraam
- Sobib termostaatidele: **T-143; T-145;T-146**
- **T-163; T-165; T-166**
- värvus: läikiv valge (RAL9016)



Art. nr.	Dimension	l mm	h mm	d mm	pakend	UOM
1086986	RAL9016	90	90	2,1	1	tk

Uponor Smatrix lisaandur S-1XX

- kasutatav koos Uponor Smatrix Wave/Base(Pro) termostaatidega
- kasutatav põranda- või kaugandurina
- pikkus: 3m
- anduri tüüp: NTC 10kOhm, 25°C



Art. nr.	L m	pakend	UOM
1071684	3	1	tk

Uponor Smatrix rele moodul K/J M-1XX

- **24V releemoodul** kütte-või jahutusseadme lülitamiseks
- K/J ümberlülitamiseks Uponor Smatrix ja K/J allika vahel
- kompl. pesa DIN siinile paigaldamiseks, juhend, paigaldustarvikud
- kontakt: 2 ümberlülituskontakti
- Umähis: 24VDC
- testi pinge: 5kV
- kaitseklass: IP40
- lülituspinge: 380VAC, 125VDC
- lülitusvool: 5A@250VAC, 5A@30VDC
- kontakti materjal: Ag+Au kattega
- temperatuuri vahemik: -40°C...+70°C



NEW

Art. nr.	Dimension	TP V	l mm	b mm	d mm	pakend	UOM
1083576	24V	24	85,5	16	70,5	1	tk

Uponor Smatrix Wave

Uponor Smatrix releemoodul K/J M-1XX

- **230 V releemoodul** kütte-või jahutusseadme lülitamiseks
- K/J ümberlülitamiseks Uponor Smatrix ja K/J allika vahel
- kompl. pesa DIN siinile paigaldamiseks, juhend, paigaldustarvikud
- kontakt: 2 ümberlülituskontakti
- Umähis: 230VAC
- testi pinge: 5kV
- kaitseklass: IP40
- lülituspinge: 380VAC, 125VDC
- lülitusvool: 5A@250VAC, 5A@30VDC
- kontakti materjal: Ag+Au kattega
- temperatuuri vahemik: -40°C...+70°C



Art. nr.	Dimension	TP V	l mm	b mm	d mm	2. pak.	pakend	UOM
1083577	230V	230	85,5	16	70,5	16	1	tk

Uponor Smatrix Base

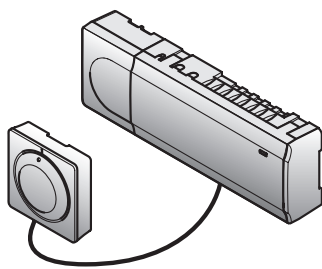

Smatrix Base-juhtmega termostaatidega süsteemile. Automaatne tasakaalustufunktsioon optimeerib energia kasutamist.

Eelised

- Kasutatav nii kiirgusküttes, kui -jahutuses
- Automaatne tasakaalustamine
- Kiire paigaldus
- Lihtne kasutada
- Väike hooldusvajadus



Kirjeldus

juhtmega termostaadid

- kuni 4 kontrolleri ühes süsteemis
- toitepinge: 230V
- automaatne tasakaalustus optimeerib energia kasutust ja mugavust
- elektriline juhtimine
- kuni 6 ruumi termostaati ja 8 ajamit (24V) kontrolleri kohta
- pumba ja katla releed
- ajami ja pumba sundkäivitus
- suhtelise niiskuse kontroll
- erinevad kaabeldusvõimalused (pärg-/tähtühendus)
- 4-sooneline Bus kaabeldus
- ühendusprotokoll: RS485 seeria bus
- ajami max. võimsus: 24VAC / 0.2A (0.4A käivitusel)
- lokaalne juurdepääs (Wi-Fi) või kaugjuurdepääs (vajalik interneti ühendus) Uponor Smatrix Pulse rakenduse abil (R-208)
- ajutine wi-fi ühenduspunkt juurdepääsuks (kui kohalik wi-fi ei ole saadaval) (R-208)
- nutikodu ökosüsteemi integratsioon (Amazon Alexa, Google Home) (R-208)
- mitme hoone juhtimine (R-208)
- kolmanda osapoole juurdepääs kaugtoeks (R-208)
- möödunud perioodi trendide analüüs Uponor Smatrix Pulse rakenduse abil (R-208)
- taimeri programmeerimine (R-208)
- mugavusseaded (R-208)
- pealevoolu diagnostika (R-208)
- ECO/comfort seadistused (I-143)

Kasutusala

- juhtmetega ruumi temperatuuri juhtimine, kiirgusküte ja -jahutus
- seadepiirkond: +5°C ... +35°C

Sertifitseerimine

- CE / EAC

Uponor Smatrix Base

Uponor Smatrix Base stardipakett Pulse S

- kasutusvalmis hooldevaba pörandakütteautomaatika stardipakett
- **juhtmega termostaadid**
- laiendatav vastavalt vajadusele
- ühildub Uponor Smatrix Base kontrolleri Pulse X-245 6X
- kaitseklass: II IP20
- värvus: valge

Komplektis:

- 1x Uponor Smatrix Pulse com R-208
- 1x Uponor Smatrix Base kontrolleri Pulse X-245 6X
- 3x Uponor Smatrix Base termostaat D+RH Style T-149
- esmapaigalduse juhend, ohutusjuhendid
- paigaldustarvikud



NEW

Art. nr.	uPoints	2. pak.	pakend	UOM
1093280	700	3	1	kompl.

Uponor Smatrix Base stardipakett Pulse L

- kasutusvalmis hooldevaba pörandakütteautomaatika stardipakett
- **juhtmega termostaadid**
- laiendatav vastavalt vajadusele
- ühildub Uponor Smatrix Base kontrolleri Pulse X-245 6X
- kaitseklass: II IP20
- värvus: valge

Komplektis:

- 1x Uponor Smatrix Pulse com R-208
- 2x Uponor Smatrix Base kontrolleri Pulse X-245 6X
- 5x Uponor Smatrix Base termostaat D+RH Style T-149
- esmapaigalduse juhend, ohutusjuhendid
- paigaldustarvikud



NEW

Art. nr.	uPoints	2. pak.	pakend	UOM
1093282	700	2	1	kompl.

Uponor Smatrix Base

Uponor Smatrix Base Pulse X-245+R-208 6X

- kasutusvalmis komplekt: kontrolleri ja ühendusmoodul R-208
- juhtmega termostaatidele
- laiendatav vastavalt vajadusele
- kaitseklass: II IP20
- Värvus: valge

Komplektis:

- 1x Uponor Smatrix Pulse com R-208
- 1x Uponor Smatrix Base kontrolleri Pulse X-245 Bus 6X
- esmapaigalduse juhend, ohutusjuhendid
- paigaldustarvikud



NEW

Art. nr.	TP V	uPoints	2. pak.	pakend	UOM
1093019	230	700	3	1	kompl.

Uponor Smatrix Pulse com Pulse com R-208

- ühendusmoodul
- **sama moodul nii juhtmega kui ka juhtmevabadele kontrolleritele/termostaatidele**
- loob ühenduse Uponor Smatrix Pulse süsteemi, Uponor Smatrix Pulse rakenduse ja Uponor pilve vahel

Ühilduvus:

- Uponor Smatrix Base kontrolleri Pulse X-245 Bus 6X
- Uponor Smatrix Wave kontrolleri Pulse X-265 6X

- toide: RJ45 kaabel Wave või Base kontrolleri
- võrguliides: 10/100 Mbps (RJ45)
- võrgu protokoll: Ethernet II
- kaitseklass: Class II IP20
- värvus: valge

Komplektis:

- Uponor Smatrix Pulse com R-208
- adapter DIN siinile paigaldamiseks
- RJ45 ühenduskaabel (2m)
- esmakäivitusjuhend, ohutusjuhised
- paigaldustarvikud



NEW

Art. nr.	Frequency MHz	l mm	b mm	d mm	uPoints	2. pak.	pakend	UOM
1093030	868	110	21	110	600	16	1	tk

Uponor Smatrix Base

Uponor Smatrix Base kontrolleri Pulse X-245 BUS 6X

- juhtmega termostaatidele
- kaitseklass: Class II IP20
- värvus: valge

Komplektis:

- Uponor Smatrix Base kontrolleri Pulse X-245 Bus 6X
- esmakäivitusjuhend, ohutusjuhised
- paigaldustarvikud



NEW

Art. nr.	TP V	l mm	b mm	d mm	uPoints	2. pak.	pakend	UOM
1093017		230	340	110 55	300	4	1	tk

Uponor Smatrix Base lisamoodul Pulse M-242 BUS 6X

- 6 kanaliga lisamoodul Uponor Smatrix Base kontrolleri Pulse X-245 Bus 6X
- lisab kuni 6 ruumi termostaati ja 6 ajamit
- click-kinnitus
- kaitseklass: IP20
- värvus: valge



NEW

Art. nr.	l mm	b mm	d mm	2. pak.	pakend	UOM
1093134	141	110	55	16	1	tk

Uponor Smatrix Base tähtmoodul Pulse M-243 BUS 6X

- 6 kanaliga tähtmoodul Uponor Smatrix Base kontrolleri Pulse X-245 Bus 6X
- täht topoloogia ühendusviis
- toetab kuni 6 termostaati
- kaitseklass: IP20
- värvus: valge



NEW

Art. nr.	l mm	b mm	d mm	2. pak.	pakend	UOM
1093135	141	110	55	16	1	tk

Uponor Smatrix Base

Uponor Smatrix Base dig. termostaat+RH Style T-149 Bus

- juhtmega termostaat
- mõõdab ja kuvab tajutavat ruumi temperatuuri ja suhtelist niiskust
- värvus: valge RAL9016

Funktsioonid:

- kütte või jahutuse vajaduse indikatsioon
- suhtelise niiskuse mõõtmine ja kuvamine
- comfort / ECO indikatsioon
- ECO seade muutmine
- K/J käsitsi ümberlülitus
- jahutuse võimaldamine (ruumipõhine)
- temperatuuri näit celsius või fahrenheit
- mõõtmisviisid: ruumi temperatuur (RT), ruumi temperatuur koos põranda max/min temperatuur (RFT), kaugandur (RS), välistemperatuuri andur (RO)
- temperatuuri näidu kalibreerimine
- lisa: põranda-, kaug- või välistemperatuuri anduri ühendamise võimalus

Komplektis:

- Uponor Smatrix Base termostaat D+RH Style T-149
- paigaldustarvikud

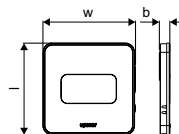

Art. nr.	l	b	w	uPoints	pakend	UOM
	mm	mm	mm			
1087813	80	9	81	100	1	tk

Uponor Smatrix Base

Uponor Smatrix Base dig. termostaat + RH Style T-149 Bus

- mõõdab ja kuvab tajutavat ruumi temperatuuri ja suhtelist niiskust
- **juhtmega termostaat**
- värvus: must

Funktsioonid:

- kütte või jahutuse vajaduse indikatsioon
- suhtelise õhuniiskuse mõõtmine ja kuvamine
- comfort / ECO indikatsioon
- ECO seade muutmine
- K/J käsitsi ümberlülitus
- jahutuse võimaldamine (ruumipõhine)
- temperatuuri näit celsius või fahrenheit
- mõõtmisviisid: ruumi temperatuur (RT), ruumi temperatuur koos põranda max/min temperatuur (RFT), kaugandur (RS), välistemperatuuri andur (RO)
- temperatuuri näidu kalibreerimine
- lisa: põranda-, kaug- või välistemperatuuri anduri ühendamise võimalus

Komplektis:

- Uponor Smatrix Base termostaat D+RH Style T-149
- paigaldustarvikud

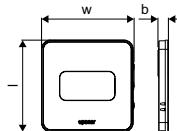

Art. nr.	Dimension	l mm	w mm	uPoints	pakend	UOM
1087814	BLACK	80	81	100	1	tk

Uponor Smatrix Base PRO temp ja RH andur Style T-141 Bus

- **juhtmega** ruumi temperatuuri ja suhtelise niiskuse **andur/termostaat**
- avalikesse ruumidesse
- seadistav läbi liidese i-147
- tehaseseadistus 21°C
- kaitseklass: IP30
- värvus: valge RAL9016

Komplektis:

- Uponor Smatrix Base PRO ruumi andur+RH Style T-141 Bus
- paigaldustarvikud



Art. nr.	Dimension	l mm	b mm	d mm	uPoints	pakend	UOM
1087812	FLUSH	55	55	9	100	1	tk

Uponor Smatrix Base

Uponor Smatrix Base taimer I-143 Bus

- juhtmega taimer (ei ole termostaat)
- esmakäivituse juhised
- puhkuse režiim
- comfort/ECO indikatsioon
- käsitsi K/J ümberlülituse funktsioon
- 6 eelprogrammeeritud graafikut
- 1 vabalt programmeeritav graafik
- ECO väärtuse seadistus
- kella korrigeerimine
- taimerifunktsioonid
- automaatse tasakaalustuse aktiveerimine/deaktiveerimine
- taustavalgus
- esmakäivitusel kuvab tarkvara versiooni
- kaitseklass: IP30
- värvus: läikiv valge

Komplektis:

- Uponor Smatrix Base taimer I-143 Bus
- paigaldustarvikud



Art. nr.	Dimension	l mm	b mm	d mm	pakend	UOM
1086978	RAL9016	80	80	26,5	1	tk

Uponor Smatrix Base progr. termostaat T-148 Bus

- programmeeritav juhtmega termostaat
- mõõdab ja kuvab tajutavat ruumi temperatuuri ja suhtelist niiskust
- kaitseklass: IP30
- värvus: läikiv valge

Funktsioonid:

- kütte või jahutuse vajaduse indikatsioon
- suhtelise niiskuse piirväärtuse indikatsioon
- individuaalne öine temperatuuri alandus
- esmakäivituse juhised
- 6 eelprogrammeeritud graafikut
- 1 vabalt programmeeritav graafik
- jahutus lubatud funktsioon (ruumipõhine)
- temperatuuri näit celsius või fahrenheit
- reguleerimisviisid: ruumi temperatuur (RT), ruumi temperatuur koos pöranda max/min (RFT), kauganduriga (RS), välistemperatuuri anduriga (RO)
- taustavalgus (tumeneb 10 sekundit peale viimast nupuvajutust)
- kuvab tarkvara versiooni (esmakäivitusel)
- lisa: pöranda või välisanduri ühendamise võimalus

Komplektis:

- Uponor Smatrix Base termostaat Prog.+RH T-148 Bus
- paigaldustarvikud



Art. nr.	Dimension	l mm	b mm	d mm	uPoints	pakend	UOM
1086977	RAL9016	80	80	26,5	100	1	tk

Uponor Smatrix Base

Uponor Smatrix Base dig. termostaat T-146 Bus

- digitaalse näiduga juhtmega termostaat
- mõõdab ja kuvab tajutavat ruumi temperatuuri
- kaitseklass: IP30
- värvus: läikiv valge

Funktsioonid:

- kütte või jahutuse vajaduse indikatsioon
- individuaalne öine temperatuuri alandus
- esmakäivituse juhised
- jahutus lubatud funktsioon (ruumipõhine)
- temperatuuri näit celsius või fahrenheit
- reguleerimisviisid: ruumi temperatuur (RT), ruumi temperatuur koos pöranda max/min (RFT), kauganduriga (RS), välistemperatuuri anduriga (RO)
- taustavalgus (tumeneb 10 sekundit peale viimast nupuvajutust)
- kuvab tarkvara versiooni (esmakäivitusel)
- lisa: pöranda anduri ühendamise võimalus

Komplektis:

- Uponor Smatrix Base termostaat T-146 Bus
- paigaldustarvikud



Art. nr.	Dimension	l mm	b mm	d mm	pakend	UOM
1086976	RAL9016	80	80	26,5	1	tk

Uponor Smatrix Base standard termostaat T-145 Bus POD

- juhtmega termostaat
- mõõdab tajutavat ruumi temperatuuri
- kaitseklass: IP30
- värvus: läikiv valge

Funktsioonid:

- reguleeritava taustavalguse seadistuse ajal
- kütte/jahutuse vajaduse indikatsioon
- mikrolüliti taimerifunktsiooni sisse/välja lülitamiseks, kui süsteemi on paigaldatud taimer
- lisa: taimerifunktsioon lubatud/ väljas

Komplektis:

- Uponor Smatrix Base termostaat standard T-145 Bus POD
- paigaldustarvikud



Art. nr.	Dimension	l mm	b mm	d mm	pakend	UOM
1086975	RAL9016	80	80	26,5	1	tk

Uponor Smatrix Base

Uponor Smatrix Base süvist. termostaat T-144 Bus

■ juhtmega termostaat

- mõõdab ja kuvab tajutavat ruumi temperatuuri
- süvistatud paigalduseks, komplektis raam
- erinevate paigaldusraamide kasutamise võimalus
- kaitseklass: IP30
- värvus: läikiv valge

Funktsioonid:

- kütte/jahutuse vajaduse indikatsioon
- mikrolüliti taimer funktsiooni lubamiseks, kui süteemi on paigaldatud taimer

Komplektis:

- Uponor Smatrix Base süvistatud termostaat T-144 Bus
- paigaldustarvikud
- välisraam



Art. nr.	Dimension	l mm	b mm	d mm	pakend	UOM
1086973	RAL9016	81,5	81,5	41,7	1	tk

Uponor Smatrix Base termostaat public T-143 Bus

■ juhtmega termostaat avalikesse ruumidesse

- mõõdab tajutavat ruumi temperatuuri
- kaitseklass: IP30
- värvus: läikiv valge

Funktsioonid:

- potentsiomeeter temperatuuri seadmiseks kaane all
- avamisandur
- releekontakt forsseeritud ECO läbi BMS
- releekontakt kütte/jahutuse ümberlülituseks
- mikrolülitiid funktsioonide või anduri valikuks
- lisa: pöranda-, välis- või kauganduri ühendamise võimalus

Komplektis:

- Uponor Smatrix Base termostaat public T-143 Bus
- paigaldustarvikud



Art. nr.	Dimension	l mm	b mm	d mm	pakend	UOM
1086972	RAL9016	80	80	26,5	1	tk

Uponor Smatrix Base

Uponor Smatrix Base termostaadi alus Style T-149 A-14X

- Termostaadi T-149 paigaldusalus seinapealsele paigaldusele
- paigaldustarvikud
- värvus: valge RAL9016

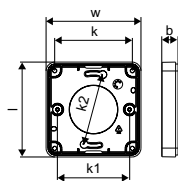

Art. nr.	l	b	k	k1	k2	w		pakend	UOM
	mm	mm	mm	mm	mm	mm			
1087821	79	14	65	60	60	79		1	tk

Uponor Smatrix Base termostaadi alus Style T-149 A-14X

- Termostaadi T-149 paigaldusalus seinapealsele paigaldusele
- paigaldustarvikud
- värvus: must

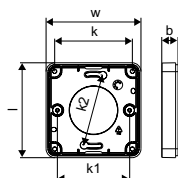

Art. nr.	Dimension	l	b	k	k1	k2	w		pakend	UOM
		mm	mm	mm	mm	mm	mm			
1087822	BLACK	79	14	65	60	60	79		1	tk

Uponor Smatrix alusraam T-X A-1XX

- Smatrix termostaatide alusraam
- Sobib termostaatidele: T-143; T-145; T-146
- T-163; T-165; T-166
- värvus: läikiv valge (RAL9016)



Art. nr.	Dimension	l	h	d		pakend	UOM
		mm	mm	mm			
1086986	RAL9016	90	90	2,1		1	tk

Uponor Smatrix Base

Uponor Smatrix Base kaabel Bus A-145

- 4-sooneline BUS kaabel Uponor Smatrix Base / Base PRO seadmete ühendamiseks
- 2xtoide / 2x andmeside
- varjestus: alumiinium/polüester kile, sidekiuga
- temperatuurivahemik: -20°C ... +80°C
- ristlõige: AWG22
- kest: PVC
- nimipinge: 400VAC/DC



Art. nr.	Dimension	L m	2. pak.	pakend	UOM
1071670	50m	50	2	1	tk

Uponor Smatrix lisaandur S-1XX

- kasutatav koos Uponor Smatrix Wave/Base(Pro) termostaatidega
- kasutatav põranda- või kaugandurina
- pikkus: 3m
- anduri tüüp: NTC 10kOhm, 25°C



Art. nr.	L m	pakend	UOM
1071684	3	1	tk

Uponor Smatrix releemoodul K/J M-1XX

- **24V releemoodul** kütte- või jahutusseadme lülitamiseks
- K/J ümberlülitamiseks Uponor Smatrix ja K/J allika vahel
- kompl. pesa DIN siinile paigaldamiseks, juhend, paigaldustarvikud
- kontakt: 2 ümberlülituskontakti
- Umähis: 24VDC
- testi pinge: 5kV
- kaitseklass: IP40
- lülituspinge: 380VAC, 125VDC
- lülitusvool: 5A@250VAC, 5A@30VDC
- kontakti materjal: Ag+Au kattega
- temperatuuri vahemik: -40°C...+70°C



Art. nr.	Dimension	TP V	l mm	b mm	d mm	pakend	UOM
1083576	24V	24	85,5	16	70,5	1	tk

Uponor Smatrix Base

Uponor Smatrix relee moodul K/J M-1XX

- **230 V releemoodul** kütte-või jahutusseadme lülitamiseks
- K/J ümberlülitamiseks Uponor Smatrix ja K/J allika vahel
- kompl. pesa DIN siinile paigaldamiseks, juhend, paigaldustarvikud
- kontakt: 2 ümberlülituskontakti
- Umähis: 230VAC
- testi pinge: 5kV
- kaitseklass: IP40
- lülituspinge: 380VAC, 125VDC
- lülitusvool: 5A@250VAC, 5A@30VDC
- kontakti materjal: Ag+Au kattega
- temperatuuri vahemik: -40°C...+70°C



Art. nr.	Dimension	TP V	l mm	b mm	d mm	2. pak.	pakend	UOM
1083577	230V	230	85,5	16	70,5	16	1	tk

Uponor Smatrix Base PRO

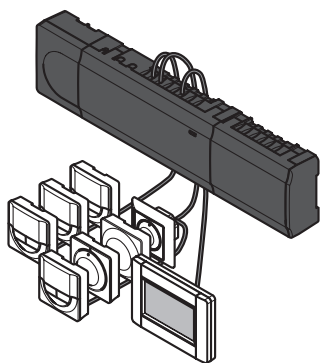

Korterelamute pörandaküt-teautomaatika.

Juhtmega termostaadid.

Kuni 16 kontrolleriit ühes süsteemis.

Kuni 192 ruumi temperatuuri juhtimine puuetundliku liidesega

Eelised

- Kasutatakse kiirguskütte ja -jahutussüsteemides
- Automaatne tasakaalustamine
- Kiire paigaldus
- Lihtne kasutus
- KNX ühilduvus

Automaatne tasakaalustus.

Ühendus Targa kodu lahendustega KNX mooduli abil



Kirjeldus

- juhtmega termostaatidele
- kuni 16 kontrolleriit ühes süsteemis
- toitepinge: 230V
- automaatne tasakaalustus optimeerib energia kasutust ja mugavust
- kuni 6 ruumi termostaati ja 8 ajamit (24V) ühe kontrolleri kohta
- pumba ja katla releed
- ajami ja pumba sundkäivitus
- suhtelise niiskuse kontroll
- erinevad kaabelduse võimalused (pärg- või tähtühendus)
- 4-sooneline BUS kaabeldus
- ühendusprotokoll: RS485
- ajami pinge ja voolutugevus: 24VAC / 0.2A (0.4A käivitusel)
- puute-ekraan kuvab kontrolleri infot ja seadeid
- alandatud temperatuuride programmid igale kanalile
- max/min temperatuuride piirangud
- puhkuse seaded
- automaatne suve/-talveaja vahetus
- möödaviikruumi „by pass“ funktsioon
- süsteemi diagnostika
- trendide kuvamine (seadearvud vs. ruumi temperatuurid, jne)
- tarvikute konfigureerimine
- lisavõimalus: BMS tugi KNX ühendusmooduliga (R-147)

Kasutusala

- kiirguskütte ja -jahutuse ruumi temperatuuride juhtimine suurets süsteemides
- termostaatide seadepiirkond: +5°C ... +35°C

Sertifitseerimine

- CE / EAC

Uponor Smatrix Base PRO

Uponor Smatrix Base PRO juhtimiskomplekt X-147 + I-147 Bus

- Kontrolleri ja puute-ekraani komplekt
- **Juhtmega termostaadid**
- Kaitseklass II IP20
- Värvus: hall RAL7015

Komplektis::

- Uponor Smatrix Base PRO puuteekraan I-147 Bus
- Uponor Smatrix Base PRO kontrolleri X-147 Bus
- paigaldustarvikud
- kirj juhend
- 2x micro SD kaart puute-ekraanile ja kontrolleri
- DIN siin
- toiteplokk ekraanile



Art. nr.	Dimension	TP V	Frequency MHz	uPoints	2. pak.	pakend	UOM
1087163	6X	230	868	700	3	1	kompl.

Uponor Smatrix Base PRO kontrolleri X-147 Bus

- ühildub Uponor Smatrix Base PRO liidesega (puute-ekraaniga) I-147 BUS
- **juhtmega termostaatidele**
- kaitseklass: Class II IP20
- värvus: hall RAL7015

Komplektis:

- Uponor Smatrix Base PRO kontrolleri X-147 Bus 6X
- kirj juhend, ohutusjuhised
- mikro SD kaart (paigaldatud)
- DIN siin (pikkus: 37cm)
- paigaldustarvikud



Art. nr.	Dimension	TP V	l mm	b mm	d mm	uPoints	2. pak.	pakend	UOM
1087162	6X	230	336	110	55	300	4	1	tk

Uponor SPI Smatrix Base PRO liides I-147 Bus

- puuetundliku ekraaniga liides kontrolleri X-147 Bus 6X
- **juhtmega ühendus kontrolleri**
- kaitseklass: Class II IP20
- värvus: valge RAL9016

Komplektis:

- Uponor Smatrix Base PRO liides I-147
- toiteühendus
- paigaldustarvikud
- seinakinnitus
- juhend



Art. nr.	l mm	b mm	d mm	uPoints	2. pak.	pakend	UOM
1087161	150	108,5	43	400	7	1	tk

Uponor Smatrix Base PRO

Uponor Smatrix Base PRO ühendusmoodul R-147 KNX

- ühendab Uponor Smatrix Base PRO süsteemi BMS süsteemiga või kolmandate osapoolte KNX seadmetega
- toitepinge: 230VAC (+10%/-15%) / 50/60Hz
- sisemine kaitse: T5 F3.15AL 250V, 5x20 3.15A kiiretoimeline
- töötemperatuur: 0°C ... +45°C
- ladustamistemperatuur: -20°C ... +70°C
- max. tarbitav võimsus: 45W
- toide: 1m kaabel europistikuga
- süsteemi ühendused: 0.2mm² ... 1.5mm²
- kaitseklass: IP20 II

Funktsioonid:

- ruumi temperatuur Uponor Base või kolmanda osapoole KNX termostaatidelt
- ruumi seadearvud Uponor Base või kolmanda osapoole KNX termostaatidelt
- ruumi suhteline niiskus Uponor Base või kolmanda osapoole KNX termostaatidelt
- ruumi pöranda temperatuur Uponor Base või kolmanda osapoole KNX termostaatidelt
- ajamite olek Uponor Base või kolmanda osapoole KNX süsteemist
- forsseeritud ECO režiim Uponor Base PRO või kolmanda osapoole KNX süsteemist
- pumba väljund Uponor Base või kolmanda osapoole KNX süsteemist
- katla väljund Uponor Base või kolmanda osapoole KNX süsteemist
- kütte/jahutuse seadekõverad Uponor Move PRO süsteemist BMS süsteemi või vastupidi
- kütte/ jahutuse režiimid Uponor Base PRO süsteemist BMS süsteemi või vastupidi

Komplektis:

- ühendusmoodul R-147 KNX
- toiteühendus
- paigaldustarvikud
- kiirjuhend



Art. nr.	TP V	l mm	b mm	d mm	uPoints	pakend	UOM
1087164	230	90	17,5	60	600	1	tk

Uponor Smatrix Base lisamoodul M-140 Bus

- 6 kanaliline lisamoodul Uponor Smatrix Base Pro kontrolleri X-147 Bus 6X
- toetab kuni 6 termostaati ja kuni 6 ajamit
- click-kinnitus
- kaitseklass: IP20
- värvus: hall



Art. nr.	l mm	b mm	d mm	2. pak.	pakend	UOM
1071690	141	110	55	16	1	tk

Uponor Smatrix Base tähtmoodul M-141 Bus

- 6 kanaliline tähtmoodul Uponor Smatrix Base Pro kontrolleri X-147 Bus 6X
- paindlik võimalik juhtmete ühendusvõimalus (tähttopoloogia)
- toetab kuni 6 termostaati
- kaitseklass: IP20
- värvus: hall



Art. nr.	l mm	b mm	d mm	2. pak.	pakend	UOM
1071651	141	110	55	16	1	tk

Uponor kollektori ajamid

Kontrolli ajami sobivust kollektoriga ajami kirjeldusest

Uponor Vario ajam S

- 24V
- sobib kasutamiseks Uponor plastkollektoriga **Vario M** ja teraskollektoriga **Vario S**
- ainult 24V kontrollritega **Smatrix Wave** ja **Base (24V)**
- Umähis: 24V/50Hz



Art. nr.	Dimension	d mm	IG mm	TP V	P W	h mm	pakend	UOM
1087778	24V	44	30x1,5	24	~ 1	58	1	kompl.

Uponor Vario ajam S

- 230V
- sobib nii Uponori plast (Vario M) kui roostevabale (Vario S) kollektorile
- ei sobi **Smatrix Wave** ega **Smatrix Base** kontrollritega
- Umähis: 230V/50Hz



Art. nr.	Dimension	d mm	IG mm	TP V	P W	h mm	pakend	UOM
1087763	230V	44	30x1,5	230	~ 1	58	1	kompl.

Uponor Vario PLUS ajam PRO 24V 1W NC

- 24V
- Sobib kasutamiseks Vario Plus vanat tüüpi Uponor moodul plastkollektoriga
- Komplektis 1 bajonetiga kollektori adaptervõru M30x1.5mm ja paigaldusjuhhis
- esmase avanemise funktsioon
- Automaatse tasakaalustuse funktsionaalsus nii uutes paigaldistes kui renoveerimisel
- kõrgus: 58 mm + adaptervõru
- käigu pikkus: 5 mm
- ühenduskaabel: 2x0,75 mm²x1m
- läbimõõt: 44,3 mm
- vastavus: EAC
- värvus: sinine



NEW

Art. nr.	Dimension	d mm	AG mm	TP V	P W	h mm	pakend	UOM
1090262	VA02 MT 30X1,5	44	30x1,5	24	~ 1	58	1	tk

Uponor kollektori ajamid

Uponor Vario PLUS ajam PRO 230V 1W NC

■ 230V

- Sobib kasutamiseks Vario Plus **vanat tüüpi Uponor moodul plastkollektoriga**
- Komplektis 1 bajonetiga kollektori adaptervõru M30x1.5mm ja paigaldusjuhised
- Esmase avanemise funktsioon
- Automaatse tasakaalustuse funktsionaalsus nii uutes paigaldistes kui renoveerimisel
- Kõrgus: 58 mm + adaptervõru
- Käigu pikkus: 5 mm
- Ühenduskaabel: 2x0,75 mm²x1m
- Läbimõõt: 44,3 mm
- Vastavus: EAC
- Värvus: sinine



Art. nr.	Dimension	d mm	AG mm	TP V	P W	h mm	pakend	UOM
1090263	VA02 MT 30X1,5	44	30x1,5	230	~ 1	58	1	tk

Uponor Vario B ajam PRO 24V 1W NC

■ 24V

- Sobib kasutamiseks vanat tüüpi **messingkollektoriga WGF**
- Komplektis bajonetiga kollektori adaptervõru M28x1.5mm ja paigaldusjuhised
- Esmase avanemise funktsioon
- Automaatse tasakaalustuse funktsionaalsus nii uutes paigaldistes kui renoveerimisel
- Kõrgus: 58 mm + adaptervõru
- Käigupikkus: 5 mm
- Ühenduskaabel: 2x0,75 mm²x1m
- Läbimõõt: 44,3 mm
- Vastavus: EAC
- Värvus: sinine



Art. nr.	Dimension	d mm	IG mm	TP V	P W	h mm	pakend	UOM
1090264	VA32 FT 28X1,5	44	28x1,5	24	~ 1	58	1	tk

Uponor Vario B ajam PRO 230V 1W NC

■ 230V

- Sobib kasutamiseks vanat tüüpi **messingkollektoriga WGF**
- Komplektis bajonetiga kollektori adaptervõru M28x1.5mm ja paigaldusjuhised
- Esmase avanemise funktsioon
- Automaatse tasakaalustuse funktsionaalsus nii uutes paigaldistes kui renoveerimisel
- Kõrgus: 58 mm + adaptervõru
- Käigupikkus: 5 mm
- Ühenduskaabel: 2x0,75 mm²x1m
- Läbimõõt: 44,3 mm
- Vastavus: EAC
- Värvus: sinine



Art. nr.	Dimension	d mm	IG mm	TP V	P W	h mm	pakend	UOM
1090265	VA32 FT 28X1,5	44	28x1,5	230	~ 1	58	1	tk

Uponor kollektori ajamid

Uponor Smatrix ajam Retrofit A-XXX

- 24V ajami ja adapterite komplekt
- komplektis kolm adapterit kollektoritega ühendamiseks, kasutusjuhend
- vahelüli kolmandate osapoolte kollektorite ja Uponor Smatrix kontrollrite vahel
- ühildub 80% turul olevate kollektoritega
- avatud/suletud indikaator
- NC (normaalselt suletud) = sulgub pingevabas olekus
- esmaavanemise funktsioon
- toetab automaatse tasakaalustuse funktsiooni
- temperatuuri vahemik: 0°C...60°C
- kõrgus: 58mm + adapterivõru
- värvus: sinine

■ info sobivuse kohta: www.uponor.com/download-centre

- käigu pikkus: 5mm
- ühenduskaabel: 2x 0.75mm² x 1m
- Umähis: 24V/50Hz
- Pmähis: 1W
- läbimõõt: 44.3mm



Art. nr.	Dimension	d mm	TP V	P W	h mm	pakend	UOM
1083575	24V, NC, 1W	44	24	~ 1	58	1	kompl.

Uponor Base

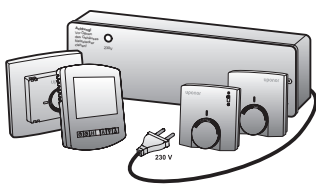

Ökonoomne 230 V pörandakütte süsteemide juhtimis-süsteem.

kahesoonelise kaabliga termostaatide ühendus.

Eelised

- Standardne 230V 2 sooneline kaabeldus
- Lihtsad termostaadid
- Lihtne paigaldada ja kasutada
- Üldlevinud kaabeldus ja juhtimine



Kirjeldus

■ 230V tööpinge

- lihtne kaabeldusviis ja regulaatorid
- lihtne siduda standardse on/off ja aja järgi juhtimisega
- lisa: pumba rele

Kasutusala

- juhtmetega ruumi temperatuuri juhtimine, pörandaküte ja -jahutus

Sertifitseerimine

- CE

Uponor Base kontrolleri X-23

- toetab kuni 6 termostaati (230V)
- toetab kuni 14 ajamit (230V)
- ülekoormuse kaitse
- võimsus: 10VA
- kaitseklass: IP40

Lisad:

- Uponor Base pumba rele X-23 (art. nr. 1058427)

Komplektis:

- Uponor Base kontrolleri X-23
- paigaldustarvikud



Art. nr.	Dimension	TP V	l mm	b mm	d mm	pakend	UOM
1058426	6X 230V	230	310	90	65	1	tk

Uponor Base

Uponor Base pumbarelee X-23

- pumba juhtimiseks
- pumba sundkäivitus (iga päev 5 minutit) paakumise vältimiseks
- ülekoormuse kaitse
- võimsus: 3VA
- kaitseklass: IP40

Komplektis:

- Uponor Base pumba relee X-23
- paigaldustarvikud



Art. nr.	Dimension	TP V	l mm	b mm	pakend UOM
1058427	230V	230	310	90	1 tk

Uponor Base kontrolleri X-24

- toetab kuni 6 termostaati (230V)
- toetab kuni 12 ajamit (230V)
- kanali pöördvalija ajamite kiireks rakendamiseks
- ülekoormuse kaitse
- võimsus: 10VA
- kaitseklass: IP40

Komplektis:

- Uponor Base flexiboard X-24
- paigaldustarvikud



Art. nr.	Dimension	TP V	l mm	b mm	d mm	pakend UOM
1088331	6X 230V	230	368	90	65	1 tk

Uponor Base kontrolleri pumba juhtimisega X-25

- toetab kuni 6 termostaati (230V)
- toetab kuni 12 ajamit (230V)
- kanalite pöördvalija ajamite kiireks rakendamiseks
- pumba relee 2A (230V)
- ülekoormuse kaitse
- võimsus: 10VA
- kaitseklass: IP40

Komplektis:

- Uponor Base flexiboard pumba releega X-25 6X
- paigaldustarvikud



Art. nr.	Dimension	TP V	l mm	b mm	d mm	pakend UOM
1089086	6X 230V	230	368	90	65	1 tk

Uponor Base

Uponor Base kontrolleri X-26

- toetab kuni 8 termostaati (230V)
- toetab kuni 12 ajamit (230V)
- kanalite pöördvalija ajamite kiireks rakendamiseks
- ülekoormuse kaitse
- võimsus: 10VA
- kaitseklass: IP40

Komplektis:

- Uponor Base flexiboard pumba releega X-26 8X
- paigaldustarvikud



Art. nr.	Dimension	TP V	l mm	b mm	d mm	pakend	UOM
1089087	8X 230V	230	368	90	65	1	tk

Uponor Base kontrolleri pumba juhtimisega X-27

- toetab kuni 8 termostaati (230V)
- toetab kuni 12 ajamit (230V)
- kanalite pöördvalija ajamite kiireks rakendamiseks
- pumba rele 2A (230V)
- ülekoormuse kaitse
- võimsus: 10VA
- kaitseklass: IP40

Komplektis:

- Uponor Base flexiboard pumba releega X-27 8X
- paigaldustarvikud



Art. nr.	Dimension	TP V	l mm	b mm	d mm	pakend	UOM
1089088	8X 230V	230	368	90	65	1	tk

Uponor Base standard termostaat T-23

- Termostaadi reguleerikettale prinditud skaala
- lihtne on/off juhtimine (bimetall)
- seadepiirkond reguleeriketta alt mehaaniliselt piiratav
- toide kontrolleri (Uponor Base kontrolleri X-23)
- seadepiirkond: +5°C ... +30°C
- ühendusjuhe: 4x 1.5mm²
- maks.juhtme pikkus: 100m
- kaitseklass: IP30
- värvus: RAL 9010



Art. nr.	Dimension	TP V	l mm	b mm	d mm	värvus	pakend	UOM
1058422	230V RAL9010	230	78	78,5	13,9	RAL 9010	1	tk

Uponor Base

Uponor Base süvistatav termostaat T-24

- reguleerikettale prinditud skaalaga termostaat süvistatud paigalduseks
- lihtne on/off juhtimine (bimetall)
- seadepiirkonna mehaanilised piirajad asuvad reguleeriketta all
- toide kontrolleriilt (Uponor Base kontrolleri X-23)
- seadepiirkond: +5°C ... +30°C
- kaabel: 4x 1.5mm²
- max. kaabli pikkus: 100m
- kaitseklass: IP30
- värvus: läikiv valge

Komplektis:

- Uponor Base termostaat süvist. T-24 230V
- välisraam 81x85x44.5mm
- kate 50x50mm



Art. nr.	Dimension	TP V	l mm	b mm	d mm		pakend	UOM
1058423*	230V	230	81	85	44,5		1	tk

Uponor Base dig. progr. termostaat T-26

- kontaktid pöranda- või kauganduri ühendamiseks
- programmeeritav - 5/2 või 7 päevale, nelja temperatuuri tasemega igale päevale
- erinevad reguleerimise võimalused - ainult õhk, ainult pörand, õhk ja pörand
- puhkuse režiim
- optimaalne käivitus
- lukustatav
- jooksva režiimi oleku kuva
- toide (Uponor Base kontrolleri X-23)
- lisa: kaugandur (eraldi toode 1047459)
- seadepiirkond: +5°C ... +35°C
- kaitseklass: IP20
- värvus: valge RAL9010



Art. nr.	Dimension	TP V	l mm	b mm	d mm	värvus	pakend	UOM
1058425	230V RAL9010	230	85	98	13	RAL 9010	1	tk

Uponor Base lisaandur

- lisaandur termostaadile T-26
- pöranda min/max temperatuur
- pikkus: 3m



Art. nr.	Dimension	L m	pakend	UOM
1047459	230V	3	1	tk

Uponor Comfort E



Lihtsalt paigaldatavad Uponor Comfort E elektrilised küttematid ja kaablid. Paigaldage elektriline põrandaküte õhukese 3 mm küttematiga keraamilise põrandakatte või Comfort E Al-kilega küttematiga

laminaat või parkettpõrandate alla. Uponor Comfort E termostaadid aitavad optimeerida küttekulusid.

Eelised

- Ideaalne nii renoveerimisel kui ka uusehitusel
- Sobib keraamilise plaadi, laminaatparketi, puitparketi või vinüülkatetega nii märg- kui kuivpaigaldusel
- Lihtne kasutada vähese kõrguse tõttu
- Lühike reageerimisaeg



Kirjeldus

- põrandaküttematid, kaablid ja termostaadid.

Kasutusala

- elektriline põrandaküte
- paigaldatakse tasanduskihti või plaatimissegusse või vahetult soojustuskihile parketi või laminaadi alla

Termostaadid:

- temperatuuri vahemik: +5°C ... +30°C
- 230V

Sertifitseerimine

- CE; EAC;
- VDE 40046886 Cable Mat

Uponor Comfort E WET-põrandakütte matt

Kirjeldus

- Elektriline lahtirullitav põrandakütte matt märgpaigalduseks
- paigaldatakse tasanduskihti või plaatimissegusse
- iseliimuv matt
- laius 0,5m
- alusele õmmeldud 3 mm kaabel
- varjestatud kahesoonele küttekaabel
- 4m ühenduskaabel
- FEP elektrilise isolatsiooniga küttekaabel
- komplektis kaitsehülss põranda andurile

Kasutusala

- Elektriline põrandaküte
- paigaldatakse tasandus - või plaatimissegusse

Sertifitseerimine

- CE; EAC;
- VDE 40046886
- IPX7

Uponor Comfort E

Uponor Comfort E küttematt

- küttevõimsus 160 W/m²



Art. nr.	Dimension	Resistans Ohm	Q W	L m	B m	A m ²	uPoints	2. pak.	pakend	UOM
1088656	160-1	326	160	2	0,5	1	140	50	1	kompl.
1088657	160-1,5	224	240	3	0,5	1,5	170	50	1	kompl.
1088658	160-2	163	320	4	0,5	2	200	50	1	kompl.
1088659	160-2,5	133	400	5	0,5	2,5	230	50	1	kompl.
1088660	160-3	110	480	6	0,5	3	260	50	1	kompl.
1088661	160-4	78	640	8	0,5	4	310	35	1	kompl.
1088662	160-5	67	800	10	0,5	5	370	35	1	kompl.
1088663	160-6	53	960	12	0,5	6	440	35	1	kompl.
1088664	160-7	45	1120	14	0,5	7	500	20	1	kompl.
1088665	160-8	41	1280	16	0,5	8	540	20	1	kompl.
1088666	160-10	32	1600	20	0,5	10	600	20	1	kompl.
1088667	160-12	28	1920	24	0,5	12	650	20	1	kompl.

Uponor Comfort E küttematt

- küttevõimsus 100 W/m²



Art. nr.	Dimension	Resistans Ohm	Q kW	L m	B m	A m ²	uPoints	2. pak.	pakend	UOM
1093461	100-1	498	100	2	0,5	1	140	50	1	kompl.
1093462	100-1,5	328	150	3	0,5	1,5	170	50	1	kompl.
1093463	100-2	259	200	4	0,5	2	200	50	1	kompl.
1093464	100-2,5	202	250	5	0,5	2,5	230	50	1	kompl.
1093465	100-3	161	300	6	0,5	3	260	50	1	kompl.
1093466	100-4	125	400	8	0,5	4	310	35	1	kompl.
1093467	100-5	98	500	10	0,5	5	370	35	1	kompl.
1093468	100-6	84	600	12	0,5	6	440	35	1	kompl.
1093469	100-7	77	700	14	0,5	7	500	20	1	kompl.
1093470	100-8	61	800	16	0,5	8	540	20	1	kompl.
1093471	100-10	53	1000	20	0,5	10	600	20	1	kompl.
1093472	100-12	42	1200	24	0,5	12	650	20	1	kompl.

Uponor Comfort E WET-küttekabel

Kirjeldus

- Elektriline küttekabel
- paigaldatakse tasanduskihti või plaatimissegusse
- kaabli läbimõõt 3mm
- varjestatud kahesooneeline küttekabel
- 4m ühenduskabel
- FEP elektrilise isolatsiooniga küttekabel
- komplektis kaitsehülss põranda andurile
- komplektis kaabli kinnitusteip

Kasutusala

- Elektriline põrandaküte
- paigaldatakse tasandus - või plaatimissegusse

Sertifitseerimine

- CE; EAC
- IPX7

Uponor Comfort E

Uponor Comfort E kaabel



Art. nr.	Dimension	Resistans Ohm	uPoints	pakend	UOM
1093451	150W 13M	353	140	1	kompl.
1093452	300W 25M	176	200	1	kompl.
1093453	460W 37M	115	230	1	kompl.
1093454	700W 54M	76	310	1	kompl.
1093455	930W 75M	57	370	1	kompl.
1093456	1100W 87M	48	480	1	kompl.
1093457	1550W 124M	34	580	1	kompl.
1093458	1850W 143M	29	620	1	kompl.

Uponor Comfort E kaabli kinniti



Art. nr.	2. pak.	pakend	UOM
1093460	20	1	tk

Uponor Comfort E DRY

Kirjeldus

- Elektriline lahtirullitav Al-kilega küttematt kuivpaigalduseks
- paigaldatakse vahetult soojusisolatsioonile parketi, laminaadi või plastkatte alla
- mõlemad pooled kaetud Al-kilega
- laius 0,5m
- FEP elektrilise isolatsiooniga küttekaabel
- 3m ühenduskaabel
- komplektis Al-teibi ribad
- komplektis kaitsehülss pöranda andurile

Kasutusala

- Elektriline pörandaküte
- paigaldatakse vahetult soojusisolatsioonile parketi, laminaadi või plastkatte alla

Sertifitseerimine

- CE; EAC
- IPX7

Uponor Comfort E AL-kilega küttematt

- küttevõimsus 140 W/m²



Art. nr.	Dimension	Resistans Ohm	Q W	L m	B m	A m ²	uPoints	2. pak.	pakend	UOM
1088684	140-1	378	140	2	0,5	1	140	50	1	kompl.
1088685	140-2	189	280	4	0,5	2	200	50	1	kompl.
1088686	140-3	126	420	6	0,5	3	260	50	1	kompl.
1088687	140-4	94	560	8	0,5	4	310	35	1	kompl.
1088688	140-5	76	700	10	0,5	5	370	35	1	kompl.
1088689	140-6	63	840	12	0,5	6	440	35	1	kompl.
1088690	140-7	54	980	14	0,5	7	500	20	1	kompl.
1088691	140-8	47	1120	16	0,5	8	540	20	1	kompl.
1088692	140-9	42	1260	18	0,5	9	570	20	1	kompl.
1088693	140-10	38	1400	20	0,5	10	600	20	1	kompl.

Uponor Comfort E

Uponor Comfort E AL-kile soojustus

- isolatsiooniplaat Uponor Comfort E AL-kilega küttemati soojuskadude vähendamiseks
- 5mm volditud XPS paneelid
- ~0,15m²K/W



Art. nr.	Dimension	l mm	b mm	2. pak.	pakend	UOM
1088707	5mm	6.25	0.8	200	5	m ²

Uponor Comfort E Termostaadid

Kirjeldus

- 230V

Kasutusala

- Elektrilise põrandakütte juhtimisseadmed
- küttematile
- Al-kilega küttematile

Sertifitseerimine

- CE; EAC

Uponor Comfort E reguleerkettaga termostaat set T-85

- reguleerkettaga termostaat T-85 Uponor elektrilise põrandakütte juhtimiseks, põrandaaduriga
- paigaldamiseks paigaldustoosile
- On / Off lülitus
- temperatuuri vahemik 5 - 30°C
- lülitusvool 16A
- korpuse kaitseklass IP30



Art. nr.	Dimension	pakend	UOM
1088705	230V	1	kompl.

Uponor Comfort E programmeeritav digitaalne termostaat flush Set T-86

- Digitaalne programmeeritav termostaat T-86 Uponor elektrilise põrandakütte juhtimiseks, põrandaaduriga
- süvitatud seinapaigaldus
- jooksva režiimi oleku kuva
- energiasäästu funktsioon
- puhkuse režiim
- temperatuuri vahemik 5 - 35°C
- käivitusvool 16mA
- korpuse kaitseklass IP20



Art. nr.	Dimension	pakend	UOM
1088819	230V	1	kompl.

Uponor Comfort E

Uponor Comfort E programmeeritav digitaalne termostaat flush Set T-87IF

- Digitaalne programmeeritav termostaat T-87IF Uponor elektrilise põrandakütte juhtimiseks, põrandaanduriga
- süvistatud seinapaigaldus või raami
- jooksva režiimi oleku kuva
- põranda andur min/max piirajaga
- energia maksumuse arvutus
- püsiva temperatuuri seade optimaalseks mugavuseks ja energiasäästuks
- programmeeritav puhkuse režiim
- võõra kasutuse kaitse
- temperatuuri vahemik 5 - 30°C
- käivitusvool 16A
- korpuse kaitseklass IP30



Art. nr.	Dimension	pakend UOM	
1088706	230V	1	kompl.

Uponor Ecoflex Thermo

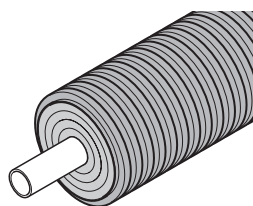

Uponor Ecoflex Thermo torud on sertifitseeritud vastavalt standardile EN 15632.

Kasutatakse kütte- ja jahutussüsteemides. Thermo Single kasutatakse suurte vooluhulkade korral. Thermo Twin - peale- ja tagasivool

Eelised

- Suurepärase painduvus
- Lihtne paigaldada
- Hea energeetiline efektiivsus
- Kestev: vähemalt 30 aastat
- Tellitav soovitud pikkuses
- Sertifitseeritud süsteem

ühes kaitsekestas.



Kirjeldus

- Painduv, eelisoleeritud isekompenseeruv plasttoru süsteem vast. EN 15632
- Voolutoru: ristseotud polüetüleenitoru (PE-Xa), vast. EN ISO 15875, naturaalse värvusega, rõhuklass PN 6 (SDR 11), hapniku difusiooni tõke vast. EN 15632
- Isolatsiooni materjal: suletud pooridega PE-X vaht, püsivalt elastne, vananemiskindel
- Kaitsekest: gofreeritud polüetüleen (HDPE)

Kasutusala

- Kütte ja jahutusvee transpordiks maaalusel paigaldusel.
- Kütte töötemperatuur 80°C, vast. EN 15632
- Lühiajaline avariitemperatuur 95°C
- Katsetatud staatiline liikluskoormuse taluvus 60 tonni

Sertifitseerimine

- Vastavustunnistused kohalikul esindajalt

Uponor Ecoflex Thermo Single

- Küte ja jahutus
- Üks hapniku difusioonitõkkega PE-Xa voolutoru
- Max. 6 bar / 95°C
- PEX vaht, HDPE kaitsekest

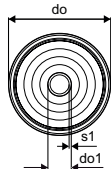

Art. nr.	Dimension	do mm	do1 mm	s1 mm	R m	Weight kg	pakend UOM
1018110	32x2,9/140	140	32	2,9	0,300	1,310	200 m
1018111	40x3,7/175	175	40	3,7	0,350	2,200	200 m
1018112	50x4,6/175	175	50	4,6	0,450	2,400	200 m
1018113	63x5,8/175	175	63	5,8	0,550	2,800	200 m
1018114	75x6,8/200	200	75	6,8	0,800	3,740	100 m
1018115	90x8,2/200	200	90	8,2	1,100	4,200	100 m
1018116	110x10,0/200	200	110	10	1,200	5,240	100 m
1083868	125x11,4/250	250	125	11,4	1,400	7,250	120 m

Uponor Ecoflex Thermo

Uponor Ecoflex Thermo Twin

- Küte ja jahutus
- Kaks hapniku difusioonitõkkega PE-Xa voolutoru
- Max. 6 bar / 95°C
- Värviline siseprofiil eraldab peale- ja tagasivoolu torud
- PEX vaht, HDPE kaitsekest

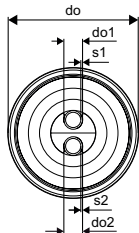

Art. nr.	Dimension	do mm	do1 mm	do2 mm	s1 mm	s2 mm	R m	Weight kg	pakend	UOM
1018134	2x25x2,3/175	175	25	25	2,3	2,3	0,500	2,200	200	m
1018135	2x32x2,9/175	175	32	32	2,9	2,9	0,600	2,400	200	m
1018136	2x40x3,7 /175	175	40	40	3,7	3,7	0,800	2,600	200	m
1018137	2x50x4,6/200	200	50	50	4,6	4,6	1,000	3,500	100	m
1018138	2x63x5,8/200	200	63	63	5,8	5,8	1,200	4,550	100	m
1088276	2x75x6,8/250	250	75	75	6,8	6,8	1,400	6,500	100	m

Uponor Ecoflex Thermo Mini

- Küte ja jahutus
- Üks hapniku difusioonitõkkega PE-Xa voolutoru
- Max. 6 bar / 95°C
- PEX vaht, HDPE kaitsekest

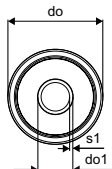

Art. nr.	Dimension	do mm	do1 mm	s1 mm	R m	Weight kg	2. pak.	pakend	UOM
1018132	25x2,3/68	68	25	2,3	0,200	0,500		200	m
1018133	32x2,9/68	68	32	2,9	0,250	0,550		200	m
1095574	32X2,9/68 L=25M	68	32	2,9			50	25	m
1095575	32X2,9/68 L=50M	68	32	2,9			50	50	m

Uponor Ecoflex Thermo PRO

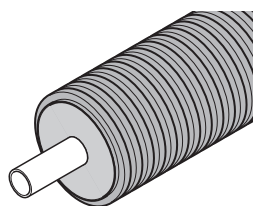

Kütte- ja jahutussüsteemidele. Ühe voolutoruga Thermo PRO suurtele vooluhulkadele.

Thermo PRO ka peale- ja tagasivoolu torudega ühes kaitsekoores

Eelised

- Suurepärase paindumus
- Lihtne paigaldada
- Hea energiatiline efektiivsus
- Kestev: vähemalt 30 aastat
- Tellitav soovitud pikkuses
- Sertifitseeritud süsteem



Kirjeldus

- Painduv, eelisoleeritud isekompenseeruv plasttoru süsteem vast. EN 15632
- Voolutoru: ristseotud polüetüleenitoru (PE-Xa), vast. EN ISO 15875, naturaalse värvusega, rõhuklass PN 6 (SDR 11), hapniku difusiooni tõke vast. EN 15632
- Isolatsiooni materjal: elastne polüuretaanvaht (PUR), väliskihis õhuke kiht suletud pooridega PE-X vaht
- Kaitsekest: gofreeritud polüetüleen (HDPE)

Kasutusala

- Kütte ja jahutusvee transpordiks maaalusel paigaldusel.
- Kütte töötemperatuur 80°C, vast. EN 15632
- Lühiajaline avariitemperatuur 95°C
- Katsetatud staatiline liikluskoormuse taluvus 60 tonni

Sertifitseerimine

- Vastavustunnistused kohalikult esindajalt

Uponor Ecoflex Thermo PRO Single

- Küte ja jahutus
- Üks hapniku difusioonitõkkega PE-Xa voolutoru
- Max. 6 bar / 95°C
- PUR vaht, HDPE kaitsekest

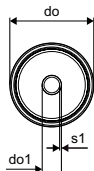

Art. nr.	Dimension	do mm	do1 mm	s1 mm	R m	Weight kg	pakend UOM
1087379	40X3,7/175	175	40	3,7	0,700	3,070	150 m
1087384	50X4,6/175	175	50	4,6	0,700	2,960	150 m
1087385	63X5,8/175	175	63	5,8	0,700	3,260	150 m
1087386	63X5,8/200	200	63	5,8	0,800	3,840	100 m
1087387	75X6,8/175	175	75	6,8	0,800	3,600	150 m
1087388	75X6,8/200	200	75	6,8	0,900	4,180	100 m
1087389	90X8,2/200	200	90	8,2	1,100	4,700	100 m
1087390	110X10,0/200	200	110	10	1,200	5,510	100 m

Uponor Ecoflex Thermo PRO

Uponor Ecoflex Thermo PRO Twin

- Küte ja jahutus
- Kaks hapniku difusioonitõkkega PE-Xa voolutoru
- Max. 6 bar / 95°C
- Üks märgistatud toru eristab peale- ja tagasivoolu
- PUR vaht, HDPE kaitsekest

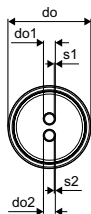

Art. nr.	Dimension	do mm	do1 mm	do2 mm	s1 mm	s2 mm	R m	Weight kg	pakend	UOM
1087392	2X25X2,3 /145	145	25	25	2,3	2,3	0,600	1,970	240	m
1087393	2X25X2,3 /175	175	25	25	2,3	2,3	0,700	2,710	150	m
1087394	2X32X2,9 /145	145	32	32	2,9	2,9	0,600	2,150	240	m
1087395	2X32X2,9 /175	175	32	32	2,9	2,9	0,800	2,870	150	m
1087396	2X40X3,7 /175	175	40	40	3,7	3,7	0,800	3,130	150	m
1087397	2X40X3,7 /200	200	40	40	3,7	3,7	1,000	3,700	100	m
1087398	2X50X4,6 /200	200	50	50	4,6	4,6	1,100	4,080	100	m
1087399	2X63X5,8 /200	200	63	63	5,8	5,8	1,200	4,690	100	m

Uponor Ecoflex Aqua

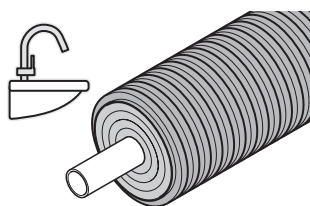

Uponor Ecoflex Aqua torusid kasutatakse hügieenilise energiasäästliku lahenduse-
na sooja tarbevee jaotusvõr-
kudes

Eelised

- Puhas ja hügieeniline
- Suurepärane painduvus
- Lihtne paigaldus
- Head soojusisolatsiooni näitajad
- Kestev: vähemalt 30 aastat
- Täielik valik liitmikke ja tarvikuid



Kirjeldus

- Painduv, eelisoleeritud isekompenseeruv plasttoru süsteem vast. EN 15632
- Voolutoru: ristseotud polüetüleentoru (PE-Xa), vast. EN ISO 15875, naturaalse värvusega, rõhuklass PN 10 (SDR 7,4)
- Isolatsiooni materjal: suletud pooridega PE-X vaht, püsivalt elastne, vananemiskindel
- Kaitsekest: gofreeritud polüetüleen (HDPE)

Kasutusala

- Sooja tarbevee transpordiks maaalusel paigaldusel.
- Tarbevee töötemperatuur 70°C, vast. EN 15875
- Lühiajaline avariitemperatuur 95°C
- Katsetatud staatiline liikluskoormuse taluvus 60 tonni

Sertifitseerimine

- Vastavustunnistused kohalikult esindajalt

Uponor Ecoflex Aqua Single

- Soe tarbevesi
- Üks PE-Xa voolutoru
- Max. 10 bar / 95°C
- PEX vaht, HDPE kaitsekest

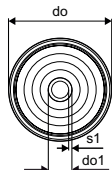

Art. nr.	Dimension	do mm	do1 mm	s1 mm	R m	Weight kg	pakend UOM
1018118	32x4,4/140	140	32	4,4	0,400	1,420	200 m
1018119	40x5,5/175	175	40	5,5	0,450	2,400	200 m
1018120	50x6,9/175	175	50	6,9	0,550	2,700	200 m
1018121	63x8,6/175	175	63	8,6	0,650	3,200	200 m
1018122*	75x10,3/200	200	75	10,3	0,900	4,340	100 m
1018123*	90x12,3/200	200	90	12,3	1,200	5,300	100 m
1036036*	110x15,1/200	200	110	15,1	1,300	6,500	100 m

* 1018122, 1018123, 1036036 tarneaeg võib olla pikem

Uponor Ecoflex Aqua

Uponor Ecoflex Aqua Twin

- Soe tarbevesi tsirkulatsiooniga
- Kaks PE-Xa voolutoru
- Max. 10 bar / 95°C
- Värviline siseprofiil eraldab pealevoolu ja tsirkulatsiooni torud
- PEX vaht, HDPE kaitsekest

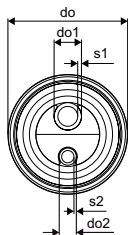

Art. nr.	Dimension	do mm	do1 mm	do2 mm	s1 mm	s2 mm	R m	Weight kg	pakend	UOM
1084885*	25x3,5-20x2,8/140	140	25	20	3,5	2,8	0,650	1,750	200	m
1084886*	32x4,4-20x2,8/175	175	32	20	4,4	2,8	0,700	2,400	200	m
1018140	32x4,4-25x3,5/175	175	32	25	4,4	3,5	0,700	2,200	200	m
1018141*	40x5,5-25x3,5/175	175	40	25	5,5	3,5	0,900	2,450	200	m
1044015*	40x5,5-32x4,4/175	175	40	32	5,5	4,4	0,900	2,800	200	m
1034188	50x6,9-32x4,4/175	175	50	32	6,9	4,4	1,000	3,100	200	m
1044016*	50x6,9-40x5,5/200	200	50	40	6,9	5,5	1,000	3,500	100	m

* 1084885, 1084886, 1018141, 1044015, 1044016 tarneaeg võib olla pikem

Uponor Ecoflex Quattro

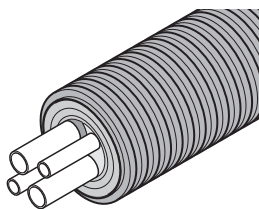

Uponor Ecoflex Quattro on kompleksne torusüsteem, kus ühes kaitsekestas on eelisoleerituna 2 kütte ja 2 sooja tarbevee toru

Eelised

- Kuluefektiivne kõik ühes paigaldus
- Energeetiliselt efektiivne
- Lihtne paigaldus
- Korrosioonikindel
- Kestev: vähemalt 30 aastat



Kirjeldus

- Painduv, eelisoleeritud isekompenseeruv plasttoru süsteem vast. EN 15632
- Voolutoru: ristseotud polüetüleentoru (PE-Xa), vast. EN ISO 15875, naturaalse värvusega, rõhuklass PN 6 (SDR 11) ja PN10 (SDR 7,4), kütetoru hapniku difusiooni tõke vast. EN 15632
- Isolatsiooni materjal: suletud pooridega PE-X vaht, püsivalt elastne, vananemiskindel
- Kaitsekest: gofreeritud polüetüleen (HDPE)

Kasutusala

- Kütte ja sooja tarbevee transpordiks maaalusel paigaldusel.
- Kütte töötemperatuur 80°C, vast. EN 15632
- Tarbevee temperatuur 70°C, vast. EN ISO 15875
- Lühiajaline avariitemperatuur 95°C
- Katsetatud staatiline liikluskoormuse taluvus 60 tonni

Sertifitseerimine

- Vastavustunnistused kohalikul esindajalt

Uponor Ecoflex Quattro

- Küte ja soe tarbevesi tsirkulatsiooniga
- Neli PE-Xa voolutoru
- Max. 6 bar küte / 10 bar tarbevesi / 95°C
- PEX vaht, HDPE kaitsekest
- värviline siseprofiil eristab peale- ja tagasivoolu torud

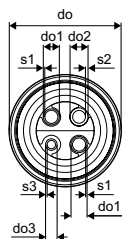

Art. nr.	Dimension	do mm	do1 mm	do2 mm	do3 mm	s1 mm	s2 mm	s3 mm	R m	Weight kg	pakend	UOM
1084887*	2x25x2,3-25x3,5-20x2,8/175	175	25	25	20	2,3	3,5	2,8	0,800	2,300	200	m
1084888*	2x32x2,9-25x3,5-20x2,8/175	175	32	25	20	2,9	3,5	2,8	0,800	2,500	200	m
1084889*	2x32x2,9-32x4,4-20x2,8/175	175	32	32	20	2,9	4,4	2,8	0,800	2,900	200	m
1018149	2x32x2,9-32x4,4-25x3,5/175	175	32	32	25	2,9	4,4	3,5	0,800	2,780	200	m
1084891*	2x40x3,7-32x4,4-20x2,8/200	200	40	32	20	3,7	4,4	2,8	1,000	3,500	100	m
1084890	2x40x3,7-40x5,5-25x3,5/200	200	40	40	25	3,7	5,5	3,5	1,000	3,600	100	m

* 1084887, 1084888, 1084889, 1084891 tarneaeg võib olla pikem

Uponor Ecoflex Quattro Midi

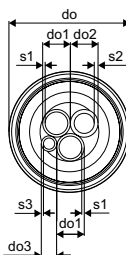

Art. nr.	Dimension	do mm	do1 mm	do2 mm	do3 mm	s1 mm	s2 mm	s3 mm	R m	Weight kg	pakend	UOM
1086836	2x25x2,3-25x3,5-20x2,8/140	140	25	25	20	2,3	3,5	2,8	0,650	1,840	200	m
1086837	2x32x2,9-25x3,5-20x2,8/140	140	32	25	20	2,9	3,5	2,8	0,700	2,000	200	m

NEW

Uponor Ecoflex Supra

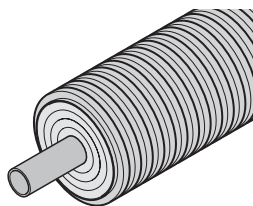

Eelised

- Hügeeniline
- Kerge paigaldus, suurepärase painduvus
- Korrosioonikindel
- Sobib standardliitmikuga



Kirjeldus

- Painduv, eelisoleeritud plasttorusüsteem
- Voolutoru: polüetüleen PE 100, must sinise triibuga, PN 16 (SDR 11)
- Isolatsioonimaterjal: suletud pooridega PE-X vaht, püsivalt elastne, vananemiskindel
- Väliskest: gofreeritud polüetüleen (HDPE)

Kasutusala

- Külma tarbevee või jahutusvee transpordik maaalusel paigaldusel.
- Töötemperatuur +20°C
- Katsetatud staatiline liikluskoormuse taluvus 60 tonni

Sertifitseerimine

- Vastavustunnistused kohalikul esindajalt

Uponor Ecoflex Supra

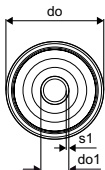

Art. nr.	Dimension	do mm	do1 mm	s1 mm	R	pakend	UOM
1095722	25x2,3/68	68	25	2,3	0.2	200	m
1095723	32x2,9/68	68	32	2,9	0.25	200	m
1095724	40x3,7/140	140	40	3,7	0.3	200	m
1095725	50x4,6/140	140	50	4,6	0.4	200	m
1095726	63x5,8/140	140	63	5,8	0.5	200	m
1095727	75x6,8/175	175	75	6,8	0.6	150	m
1095728	90x8,2/175	175	90	8,2	0.7	100	m
1095729	110x10,0/200	200	110	10	1.2	100	m

Uponor Ecoflex Supra PLUS

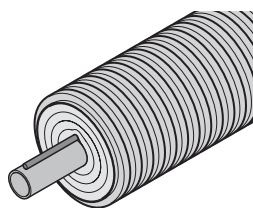

Uponor Ecoflex Supra PLUS kasutatakse külma tarbevee ühendusteks. Isereguleeruva külmumisvastase kaabliga, mida juhitakse spetsiaalse juhtseadmega. Kasutatav ka väga madalatel välistemperatuuridel

Eelised

- Vastupidav ja hooldevaba
- Lihtsad elektrilised ühendused
- Puhas ja hügieeniline
- Korrosioonikindel
- Energiasäästlik külmumiskaitse
- Võib kasutada ka survekandisatsioonina



Kirjeldus

- Painduv, eelisoleeritud plasttorusüsteem
- Voolutoru: polüetüleen PE80, PN 12,5 (SDR 11) või PE100, PN 16 (SDR 11), must sinise triibuga või PE 100, PN 16 (SDR 11), must sinise kattekihiga
- Kaabel: isereguleeruv külmumisvastane kaabel, nimivõimsus 10W/m, 5°C, maksimaalne pikkus ühest elektri ühenduspunkti 150 m
- Paigaldustoru: PE toruke temperatuuri anduri sisestamiseks.
- Isolatsioon: suletud pooridega PE-X vaht, püsivalt elastne, vananemiskindel
- Kaitsekest: gofreeritud polüetüleen (HDPE)

Kasutusala

- Külma tarbevee transpordiks külmumisriskiga kohtades maaalusel paigaldusel.
- Töötemperatuur +20°C
- Katsetatud staatiline liikluskoormuse taluvus 60 tonni

Sertifitseerimine

- Vastavustunnistused kohalikul esindajalt

Uponor Ecoflex Supra PLUS

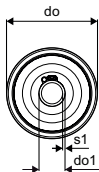

Art. nr.	Dimension	do mm	do1 mm	s1 mm	R mm	pakend UOM
NEW 1095730	25x2,3/68 1x10W/m	68	25	2,3	0,5	150 m
NEW 1095731	32x2,9/68 1x10W/m	68	32	2,9	0,5	150 m
NEW 1095733	40x3,7/90 1x10W/m	90	40	3,7	0,7	150 m
NEW 1095734	40x3,7/140 1x10W/m	140	40	3,7	0,8	150 m
NEW 1095735	50x4,6/90 1x10W/m	90	50	4,6	0,8	150 m
NEW 1095736	50x4,6/140 1x10W/m	140	50	4,6	0,8	150 m
NEW 1095737	63x5,8/140 1x10W/m	140	63	5,8	0,8	150 m
NEW 1095738	75x6,8/175 1x10W/m	175	75	6,8	1,0	150 m
NEW 1095739	90x8,2/200 1x10W/m	200	90	8,2	1,2	100 m
NEW 1095740	110x10,0/200 1x10W/m	200	110	10	1,2	100 m

Uponor Ecoflex Supra PLUS

Uponor Ecoflex Supra PLUS ühendus ja lõpupakett

- Supra PLUS toru ühendus ja lõpupakett
- Juhtseade max. 150m pikkusele külmumisvastasele kaablile
- Andur koos 5m kaabliga
- S1 kaabli ühenduse ja lõpu komplekt
- Kaks kummist otsakatet

NB! Ei sisalda voolutoru liitmikku



Art. nr.	Dimension	d mm	do mm	Weight kg	pakend UOM
1048697	25+32/68	25+32	68	100,000	1 tk
1048698	40+50/90	40+50	90	1,080	1 tk
1048699	40+50+63/140	40+50+63	140	1,530	1 tk
1048700	75/175	75	175	1,640	1 tk
1048702	90+110/200	90+110	200	1,920	1 tk

Uponor Ecoflex Supra PLUS juhtseade 150

- Supra PLUS kütte juhtseade
- kuni max. 150m külmumisvastasele kaablile
- komplektis andur 5m kaabliga

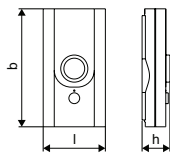

Art. nr.	l mm	b mm	h mm	Weight kg	pakend UOM
1048703	87	165	39	0,300	1 tk

Uponor Ecoflex Supra PLUS harukomplekt

- Kaitsekesta kolmiku pakett
- ABS isolatsioonikoorikud koos isolatsiooni ja üleminekutega
- S2 komponendid kaabli kolmikühenduseks
- Liikluskoormus kuni 60 tonni

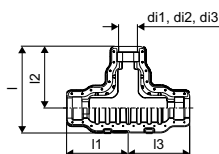

Art. nr.	Dimension	l mm	l1 mm	l2 mm	l3 mm	di1 mm	di2 mm	di3 mm	Weight kg	2. pak.	pakend UOM
1061641	140/90/68	666	470	470	470	140	90	68	9,880	5	1 tk
1061642	200/175/140	786	532	562	562	200	175	140	13,630	3	1 tk

Uponor Wipex

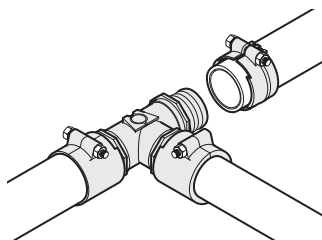

Kasutatakse PEX-torude ühendamiseks sooja ja külma vee ning kütte lokaal- ja tsentraalvõrkudes. Läbimõõtudele 25 - 110 mm rõhuklassiga PN 6 ja PN 10. Ühenduste tihendamine O-tihenditega.

Kõikidele Ecoflex torudele sobivad ka Q&E liitmikud (vt. Q&E jaotist kataloogis)

Eelised

- Lihtne ühendada, pakkimiseta
- korrosioonikindel
- Puhas ja hügieeniline
- Kestev
- Materjal: kõrgekvaliteediline DR messing



Kirjeldus

- Wipex liitmikud korrosioonikindlast messingist, tsingikaovaba vast. DIN EN ISO 6509, roostevabast terasest pingutuspolst.
- Wipex liitmiku ja muude ühenduskomponentide tihendamine O-tihendiga
- Pingutuspolsti komplekt roostevaba teras
- Eelavatud klambriga, läbimõõtudele 63-110mm.
- Saadaval ka Q&E liitmikud kuni 75 mm vt. vastavat jaotist kataloogis!

Kasutusala

- Torusüsteemide Thermo, Aqua, Quattro, Supra, Supra PLUS ja Supra Standard ühenduste tegemiseks
- PE ja PE-Xa voolutorude liitmike ühendus: silindriline torukeere (VK)
- Saadaval ka Q&E liitmikud kuni 75mm.
- Max. töötemperatuur 95°C

Sertifitseerimine

- Vastavustunnistused kohalikult esindajalt

Uponor Wipex liitmik PN6

- PE-Xa või PE torude ühendamiseks
- Silindriline keere G^{1/2}, O-tihendiga
- Max. 6 bar / 95°C
- DR = tsingikaovaba messing

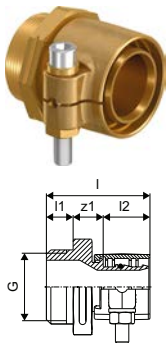

Art. nr.	Dimension	l mm	l1 mm	l2 mm	G "	z1 mm	p bar	Weight kg	2. pak.	pakend	UOM
1018328	25x2,3-G1	47	12	21	1	14	6	0,200	40	1	tk
1018329	32x2,9-G1	52	12	26	1	14	6	0,300	20	1	tk
1018330	40x3,7-G1 1/4	61	16	30	1 1/4	15	6	0,500	10	1	tk
1018331	50x4,6-G1 1/4	68	16	37	1 1/4	16	6	0,700	10	1	tk
1018332	63x5,8-G2	84	20	47	2	18	6	1,200	8	1	tk
1018333	75x6,8-G2	92	20	51	2	21	6	1,500	6	1	tk
1018334	90x8,2-G3	105	24	60	3	22	6	2,400	4	1	tk
1018335	110x10,0-G3	118	24	72	3	22	6	3,500	3	1	tk

Uponor Wipex

Uponor Ecoflex liitmik PN6

- PE-Xa või PE torude ühendamiseks
- Silindriline keere R", pakitav
- Max. 6 bar / 95°C
- DR = tsingikaovaba messing

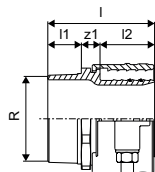

Art. nr.	Dimension	l	l1	l2	G	R	z1	p	Weight	pakend	UOM
		mm	mm	mm	"	"	mm	bar	kg		
1078368	125x11,4-R4	137	43	70	3/4	4	24	6	5,240	1	tk

Uponor FPL-X surveliitmik DR PN 10

- FPL-X
- DR = tsingikaovaba messing

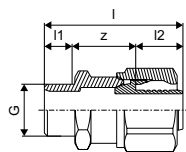

Art. nr.	Dimension	l	l1	l2	G	z1	Weight	2. pak.	pakend	UOM
		mm	mm	mm	"	mm	kg			
1085371	20x2,8-1"MT	54	17	19	1/2	18	0,200	50	1	tk

Uponor Ecoflex surveliitmik PN10

- PE-Xa või PE torude ühendamiseks
- Kooniline keere R", pakitav
- Max. 10 bar / 95°C



NEW

Art. nr.	Dimension	l	l1	l2	R	z1	p	Weight	2. pak.	pakend	UOM
		mm	mm	mm	"	mm	bar	kg			
1091505	20x2,8-3/4"	46	16	13	3/4	17	10	0,121	10	1	tk

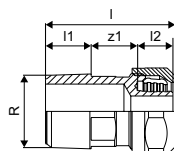

Uponor Wipex

Uponor Wipex liitmik PN10

- PE-Xa või PE torude ühendamiseks
- Silindriline keere G", O-tihendiga
- Max. 10 bar / 95°C
- DR = tsingikaovaba messing

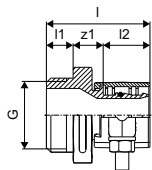

Art. nr.	Dimension	l mm	l1 mm	l2 mm	G "	z1 mm	p bar	Weight kg	2. pak.	pakend	UOM
1018336	25x3,5-G1	47	12	21	1	14	10	0,200	40	1	tk
1018338	32x4,4-G1	52	12	26	1	14	10	0,300	20	1	tk
1018339	40x5,5-G1 1/4	61	16	30	1 1/4	16	10	0,500	10	1	tk
1018340	50x6,9-G1 1/4	68	16	37	1 1/4	16	10	0,700	10	1	tk
1018341	63x8,6-G2	84	20	46	2	18	10	1,200	8	1	tk
1018342	75x10,3-G2	92	20	51	2	21	10	1,500	6	1	tk
1018343*	90x12,3-G3	105	24	59	3	22	10	2,400	4	1	tk
1023170*	110x15,1-G3	118	24	72	3	22	10	3,200	3	1	tk

Uponor Wipex jätk PN6

- PE-Xa või PE torude jätkamiseks
- Max. 6 bar / 95°C
- DR = tsingikaovaba messing

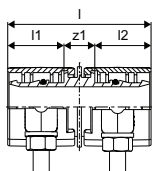

Art. nr.	Dimension	l mm	l1 mm	l2 mm	z1 mm	p bar	Weight kg	2. pak.	pakend	UOM
1042972	25x2,3-25x2,3	54	21	21	12	6	0,180	30	1	tk
1042973	32x2,9-32x2,9	63	26	26	12	6	0,340	25	1	tk
1042980	40x3,7-40x3,7	71	29	29	13	6	0,540	15	1	tk
1042984	50x4,6-50x4,6	85	36	36	13	6	0,990	10	1	tk
1042981	63x5,8-63x5,8	105	46	46	13	6	1,530	5	1	tk
1042985	75x6,8-75x6,8	123	51	51	22	6	2,270	3	1	tk
1042986	90x8,2-90x8,2	142	59	59	24	6	3,500	4	1	tk
1042987	110x10-110x10	166	71	71	24	6	4,820	2	1	tk

Uponor Ecoflex jätk PN6

- PE-Xa või PE torude jätkamiseks
- Max. 6 bar / 95°C
- DR = tsingikaovaba messing

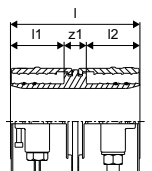

Art. nr.	Dimension	l mm	l1 mm	l2 mm	z1 mm	p bar	Weight kg	2. pak.	pakend	UOM
1078365	125x11,4-125x11,4	169	70	70	29	6	8,150		1	tk

Uponor Wipex

Uponor Wipex jätk PN10

- PE-Xa või PE torude jätkamiseks
- Max. 10 bar / 95°C
- DR = tsingikaovaba messing

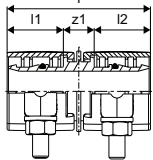

Art. nr.	Dimension	l	l1	l2	z1	p	Weight	2. pak.	pakend	UOM
		mm	mm	mm	mm	bar	kg			
1042974	32x4,4-32x4,4	64	26	26	12	10	0,340	25	1	tk
1042979*	40x5,5-40x5,5	72	30	29	13	10	0,540	15	1	tk
1042983*	50x6,9-50x6,9	86	37	36	13	10	0,960	10	1	tk
1042982*	63x8,6-63x8,6	106	47	46	13	10	0,160	4	1	tk

Uponor Wipex kolmik

- Silindriline keere G", tihendiga
- Max. 10 bar / 95°C
- DR = tsingikaovaba messing

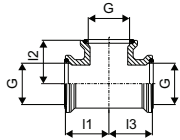

Art. nr.	Dimension	l1	l2	l3	G	G1	G2	p	Weight	2. pak.	pakend	UOM
		mm	mm	mm	"	"	"	bar	kg			
1018345	G1-G1-G1	35	35	35	1	1	1	6+10	0,31020		1	tk
1018346	G1 1/4-G1 1/4-G1 1/4	42	42	42	1 1/4	1 1/4	1 1/4	6+10	0,48010		1	tk
1018347	G2-G2-G2	55	55	55	2	2	2	6+10	1,0104		1	tk
1018348	G3-G3-G3	75	75	75	3	3	3	6+10	2,6403		1	tk

Uponor Ecoflex kolmik

- Kooniline keere R", pakitav
- Max. 10 bar / 95°C
- DR = tsingikaovaba messing

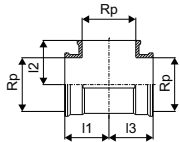

Art. nr.	Dimension	l1	l2	l3	Rp	p	Weight	pakend	UOM
		mm	mm	mm	"	bar	kg		
1078367	Rp4-Rp4-Rp4	91	91	91	4	6	3,960	1	tk

Uponor Wipex

Uponor Wipex põlv

- Silindriline keere G^{1/2}, tihendiga
- Max. 10 bar / 95°C
- DR = tsingikaovaba messing

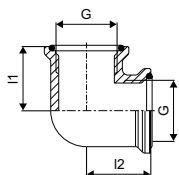

Art. nr.	Dimension	l1 mm	l2 mm	G "	G1 "	p bar	Weight kg	2. pak.	pakend	UOM
1018350	G1-G1	35	35	1	1	6+10	0,270	20	1	tk
1018351	G1 1/4-G1 1/4	42	42	1 1/4	1 1/4	6+10	0,450	15	1	tk
1018352	G2-G2	55	55	2	2	6+10	0,940	5	1	tk
1018353*	G3-G3	75	75	3	3	6+10	2,200	2	1	tk

Uponor Ecoflex põlv

- Kooniline keere R⁴, pakitav
- Max. 10 bar / 95°C
- DR = tsingikaovaba messing

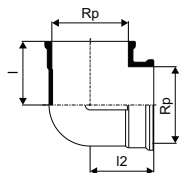

Art. nr.	Dimension	l1 mm	l2 mm	Rp "	p bar	Weight kg	pakend	UOM
1078366	Rp4-Rp4	92	92	4	6	3,280	1	tk

Uponor Wipex muhv

- Silindriline keere G^{1/2}, tihendiga
- Max. 10 bar / 95°C
- DR = tsingikaovaba messing

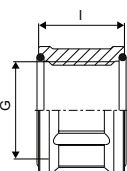

Art. nr.	Dimension	l mm	G "	p bar	Weight kg	2. pak.	pakend	UOM
1018355*	G1-G1	30	1	6+10	0,190	40	1	tk
1018356*	G1 1/4-G1 1/4	37	1 1/4	6+10	0,210	25	1	tk
1018357	G2-G2	45	2	6+10	0,420	15	1	tk
1018358	G3-G3	55	3	6+10	0,880	10	1	tk

Uponor Wipex

Uponor Wipex siirdmik välis x sise

- Silindriline keere G", tihendiga
- Max. 10 bar / 95°C
- DR = tsingikaovaba messing

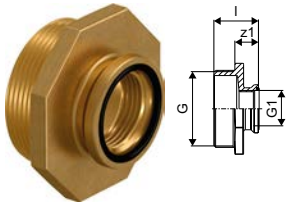

Art. nr.	Dimension	l mm	G "	G1 "	z1 mm	p bar	Weight kg	2. pak.	pakend	UOM
1018368	G1 1/4-G1	36	1 1/4	1	20	6+10	0,230	25	1	tk
1018371	G2-G1	41	2	1	21	6+10	0,390	15	1	tk
1018372	G2-G1 1/4	45	2	1 1/4	25	6+10	0,400	15	1	tk
1018374	G3-G1	47	3	1	23	6+10	0,870	6	1	tk
1018375	G3-G1 1/4	51	3	1 1/4	27	6+10	0,880	10	1	tk
1018376	G3-G2	55	3	2	31	6+10	0,890	10	1	tk

Uponor Ecoflex siirdmik välis x sise

- Kooniline väliskeere R", pakitav
- Silindriline sisekeere G", tihendiga
- Max. 10 bar / 95°C
- DR = tsingikaovaba messing

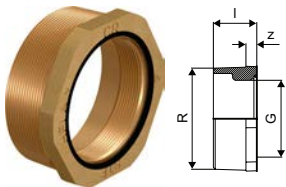

Art. nr.	Dimension	l mm	G "	R "	z mm	p bar	Weight kg	2. pak.	pakend	UOM
1078369	R4-G3	48	3	4	12	6	1,400	6	1	tk

Uponor Ecoflex äärrik

- Kooniline keere R", pakitav
- Max. 10 bar / 95°C
- Roostevaba teras

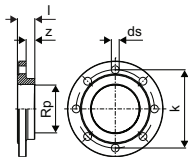

Art. nr.	Dimension	no. tk	p bar	Weight kg	pakend	UOM
1078370*	F100/8-180/Rp4	8	6	4,500	1	tk

Uponor Wipex

Uponor Wipex

Pöördnippel

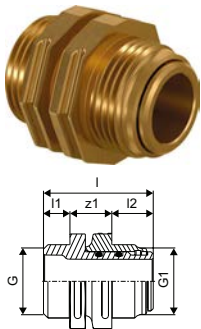

Art. nr.	Dimension	l mm	l1 mm	l2 mm	G "	G1 "	z1 mm	p bar	Weight kg	2. pak.	pakend	UOM
1045455	G1	50	12	19	1	1	19	6+10	0,260	20	1	tk
1045456	G1 1/4-G1	50	12	21	1	1 1/4	17	6+10	0,350	20	1	tk
1045457	G1 1/4	58	16	21	1 1/4	1 1/4	21	6+10	0,500	15	1	tk
1045458	G2-G1 1/4	68	16	25	1 1/4	2	27	6+10	2,000	10	1	tk
1045459	G2	74	20	25	2	2	29	6+10	1,170	10	1	tk
1045460	G3-G2	82	24	25	3	2	33	6+10	1,790	3	1	tk
1045461	G3	89	24	30	3	3	35	6+10	2,750	2	1	tk

Uponor Wipex ankurdusliitmik

- Silindriline keere G^a, tihendiga
- Max. 10 bar / 95°C
- DR = tsingikaovaba messing

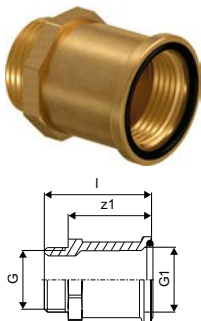

Art. nr.	Dimension	l mm	G "	G1 "	z1 mm	p bar	Weight kg	2. pak.	pakend	UOM
1018303	G1 1/4	84	1 1/4	1 1/4	68	6+10	0,450	10	1	tk
1018304	G2	93	2	2	73	6+10	0,780	5	1	tk
1018305*	G3	135	3	3	111	6+10	2,150	5	1	tk

Uponor Wipex nippel

- Silindriline keere G^a
- Max. 10 bar / 95°C
- DR = tsingikaovaba messing

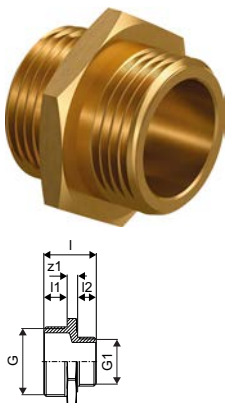

Art. nr.	Dimension	l mm	l1 mm	l2 mm	G "	G1 "	z1 mm	p bar	Weight kg	2. pak.	pakend	UOM
1009041*	G3xG1 1/4	51	24	16	3	1 1/4	11	6+10	0,940	10	1	tk
1009042	G3xG2	55	24	20	3	2	11	6+10	0,950	10	1	tk

Uponor Wipex

Uponor Wipex siirdmik S-Press PN6

- PE-Xa ja Uponor MLC torude omavaheliseks ühendamiseks.
- Max. 6 bar
- DR = tsingikaovaba messing

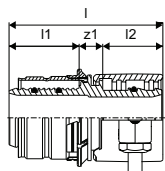

Art. nr.	Dimension	l	l1	l2	do	s	z1	p	Weight	2. pak.	pakend	UOM
		mm	mm	mm	mm	mm	mm	bar	kg			
1060058	32x2,9-32x3,0	66	30	26	15	2,5	10	6	0,244	25	1	tk

Uponor Wipex siirdmik S-Press PN6

- PE-Xa ja Uponor MLC torude omavaheliseks ühendamiseks.
- Max. 6 bar / 95°C või 16 bar / 20°C
- DR = tsingikaovaba messing

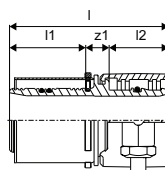

Art. nr.	Dimension	l	l1	l2	do	s	z1	p	Weight	2. pak.	pakend	UOM
		mm	mm	mm	mm	mm	mm	bar	kg			
1060059	40x3,7-40x4,0	79	38	30	18	2,5	12	6	0,407	15	1	tk
1060060	50x4,6-50x4,5	86	38	37	18	2,5	12	6	0,655	10	1	tk

Uponor Ecoflex

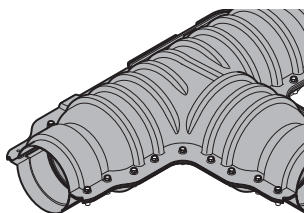

Süsteem sisaldab laia valikut kütte, jahutuse ja tarbevee võrkude ehitamiseks vajalikke tarvikuid. Kasutatakse koos Uponor Ecoflex torude ja liitmikega.

Eelised

- Komponentide praktiline ja kiire paigaldus
- Vastupidavad ja ohutud
- Täielik valik igaks vajaduseks



Kirjeldus

- Kõik tarvikud on korrosioonikindlad.

Kasutusala

- Ecoflex tarvikud sobivad kasutamiseks maaalusel paigaldusel.

Sertifitseerimine

- Vastavustunnistused kohalikul esindajalt

Uponor Ecoflex kummist otsakate Single

- Ühele voolutorule
- Kaitseb toru otsa niiskuse ja mustuse eest
- Veetihe kuni 0,3 bar
- EPDM kummist otsakate, roostevaba terasest klamber ja tihend

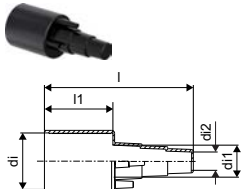

NEW

Art. nr.	Dimension	l mm	l1 mm	d1 mm	d1 mm	d2 mm	d0 mm	no. tk	Weight kg	pakend	UOM
1018316	25+32+40/68	174	80	66	37,4	21,4		1	0,150	1	tk
1018315	25+28+32/140+145	184	90	132	30	21,4		1	0,330	1	tk
1036248	32+40+50/90	174	80	87	47	28		1	0,190	1	tk
1018313	32+40+50/175	184	90	166	47	28		1	0,420	1	tk
1018314	40+50+63/140+145	184	90	132	59	34,5		1	0,340	1	tk
1095801	63+75+90/140						63+75+90/140			1	tk
1018312	63+75/175	184	90	166	70,3	56		1	0,440	1	tk
1018310	75+90+110/200	184	90	190	103	67		1	0,510	1	tk
1067757	125/200	142	90	190	117	109		1	0,550	1	tk
1083869*	90+110+125/250	200	90	235	117	81		1	0,670	1	tk

Uponor Ecoflex

Uponor Ecoflex kummist otsakate Twin

- Kahele voolutorule
- Kaitseb toru otsa niiskuse ja mustuse eest
- Veetihe kuni 0,3 bar
- Komplektis EPDM kummist otsakate, roostevabast terasest klamber ja tihend

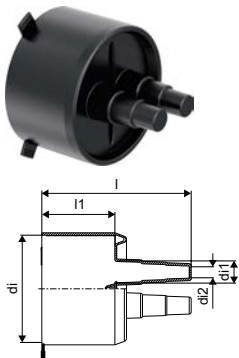

Art. nr.	Dimension	l mm	l1 mm	di mm	di1 mm	di2 mm	no. tk	Weight kg	pakend UOM	
1034305*	18-20+22-25+28/140+145	184	90	132	18	28	2	0,330	1	tk
1034306*	18-22+25+28/25-28+32+40/175	184	90	166	18	40	2	0,440	1	tk
1018309	25+32+40/175	184	90	166	25	40	2	0,440	1	tk
1018308	25+32+50/175	184	90	166	25	50	2	0,450	1	tk
1018307	40+50+63/200	184	90	190	40	63	2	0,520	1	tk
1088979	75+90/250	194	90	235	67	84	2	0,800	1	tk

Uponor Ecoflex Quattro

- Neljale voolutorule
- Kaitseb toru otsa niiskuse ja mustuse eest
- Veetihe kuni 0,3 bar
- Komplektis EPDM kummist otsakate, roostevabast terasest klamber ja tihend

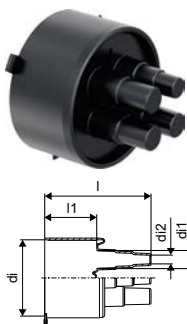

Art. nr.	Dimension	l mm	l1 mm	di mm	di1 mm	di2 mm	no. tk	Weight kg	pakend UOM	
1086838*	20+25+32/140	184	90	132	30	15	4	0,450	1	tk
1018306	18-32+25-32/175	184	90	166	30	15	4	0,490	1	tk
1034308	18-28+32+40/200	184	90	182	37,5	21,4	4	0,800	1	tk

Uponor Ecoflex kolmiku isol komplekt

- Kaitsekesta kolmiku pakett
- ABS isolatsioonikoorigud koos isolatsiooni ja üleminekutega
- Liikluskoormus kuni 60 tonni

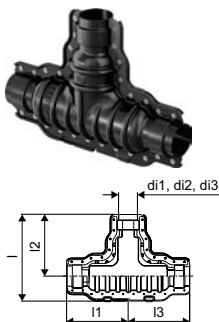

Art. nr.	Dimension	l mm	l1 mm	l2 mm	l3 mm	di1 mm	di2 mm	di3 mm	Weight kg	2. pak.	pakend UOM	
1060986	140/90/68	666	470	470	470	140	90	68	9,770	5	1	tk
1060982	200/175/145/140	786	562	562	562	200	175	140	13,530	4	1	tk

Uponor Ecoflex

Uponor Ecoflex põlve isol. komplekt

- Kaitsekesta põlve pakett
- ABS isolatsioonikoorikud koos isolatsiooni ja üleminekutega
- Liikluskoormus kuni 60 tonni

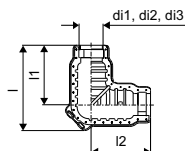

Art. nr.	Dimension	l mm	l1 mm	l2 mm	di1 mm	di2 mm	di3 mm	Weight kg	2. pak.	pakend	UOM
1060985	200/175/145/140	806	563	563	200	175	140	10,550	3	1	tk

Uponor Ecoflex jätku isol. komplekt

- Kaitsekesta jätku pakett
- ABS isolatsioonikoorikud koos isolatsiooni ja üleminekutega
- Liikluskoormus kuni 60 tonni

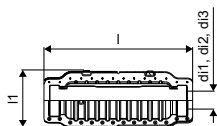

Art. nr.	Dimension	l mm	l1 mm	di1 mm	di2 mm	di3 mm	Weight kg	2. pak.	pakend	UOM
1060984	200/175/145/140	1125	426	200	175	140	9,660	6	1	tk

Uponor Ecoflex kolmiku vahtkoorik

- PUR vaht isolatsioonielemendid, kahest poolest koosnev komplekt, kasutatav koormuseta alal

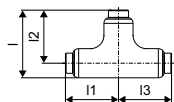

Art. nr.	Dimension	l mm	l1 mm	l2 mm	l3 mm	Weight kg	pakend	UOM
1090042	200/175/145/140	450	353	353	353	1,080	1	tk

Uponor Ecoflex kaitsekesta ühenduskompl.

- Kaitsekesta jätku pakett
- Komplektis muhv ja kaks kuumahenevat hülssi
- Koormustaluvus 60 tonni

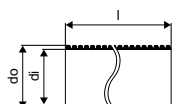

Art. nr.	Dimension	l mm	di mm	do mm	s mm	Weight kg	2. pak.	pakend	UOM
1084574*	175+200	650	218	250		2,800	10	1	tk
1083872*	250	720	275	315		4,700	9	1	tk

Uponor Ecoflex

Uponor Ecoflex harukaev

- Ühenduskaev
- PE korpus, isolatsioon ja üleminekud
- Saadaval T ja X mudelid
- Liikluskoormus 500 kg, suuremate koormuste puhul kasutada spetsiaalseid betoonkonstruktsioone

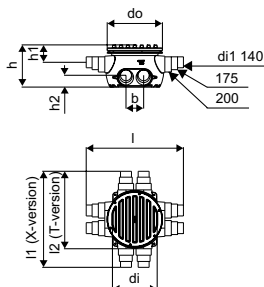

Art. nr.	Dimension	l mm	l1 mm	l2 mm	di mm	do mm	b mm	h mm	h1 mm	h2 mm	no. tk	Weight kg	pakend UOM
1018326	6x140/145/175/200	1652		1316	760	940	300	725	420	200	6	52,000	3 tk
1018327*	8x140/145/175/200	1652	1632		760	940	300	725	420	200	8	53,000	3 tk
1084576*	2x250-6x140/145/175/200	1652	1486		760	940	300	725	420	165	8	53,000	1 tk
1084577*	4x250-4x140/145/175/200	1652	1304		760	940	300	725	420	165	8	53,000	1 tk
1084578*	6x250-2x140/145/175/200	1486	1304		760	940	300	725	420	165	8	53,000	1 tk

Uponor Ecoflex kuumahenev tihend

- Tihendab kaitsekaevu või mõne muu väljundiga

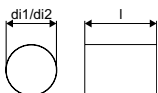

Art. nr.	Dimension	l mm	di1 mm	di2 mm	Weight kg	2. pak.	pakend UOM
1084575	250	300	330	165	0,720	15	1 tk

Uponor Ecoflex kuumahenev kattetihend

- Paigalduspogna või kaevu ühenduse tihendamiseks, tõmbelukuga
- Võimalik hilisem paigaldus

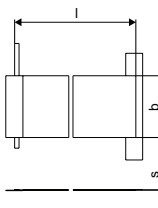

Art. nr.	Dimension	l mm	s mm	b mm	Weight kg	2. pak.	pakend UOM
1034312	140/175/200/250	960	1,3	220	0,473	10	1 tk

Uponor Ecoflex

Uponor Ecoflex ühenduspõlv Twin

- Eelisoleeritud PE-Xa toru põlv
- Kaks PE-Xa voolutoru
- Max. 6 bar / 95°C
- PUR vaht, PE kaitsekiht

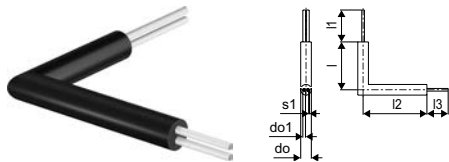

Art. nr.	Dimension	l mm	l1 mm	l2 mm	l3 mm	do1 mm	do2 mm	s1 mm	Weight kg	pakend	UOM
1085105	2X63X5,8/205	900	600	1200	400	200	63	63	5,8	17,300	1 ea
1088822	2x75x6.8/250	900	560	1200	375	250	75	75	6,8	22,400	1 ea

Uponor Ecoflex läbiviigukomplekt NPW

- Valubeton või kivisein, läbiviigu tihendamiseks
- NWP = mitte survele vee isoleerimiseks
- Komplektis PE toru ja kuumahenev käis

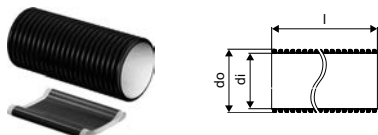

Art. nr.	Dimension	l mm	di mm	do mm	Weight kg	2. pak.	pakend	UOM
1018267	68+90	550	95	110	1,00		1	tk
1018269	140+145	550	175	200	1,300		1	ea
1018268	175+200	550	218	250	1,900		1	tk
1083871*	250	550	275	315	2,9	16	1	tk

Uponor Ecoflex läbiviigutihend

- Betoon või kiviseintele
- Vältib niiskuse tungimist hoonesse
- Radooni tõkestamine testitud. Läbiviigutihend koos pingutusvõõga

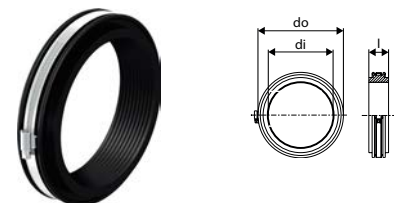

Art. nr.	Dimension	l mm	di mm	do mm	Weight kg	2. pak.	pakend	UOM
1034202	140+145	40	140	190	0,349	40	1	tk
1034203	175	40	175	225	0,435	30	1	tk
1034204	200	50	200	250	0,616	20	1	tk
1090415	250	50	250	300	0,785		1	tk

Uponor Ecoflex paigalduspöogen

- Kasutatakse Ecoflex toru sisenemisel hoonesse läbi valatud põrand



Art. nr.	Dimension	d mm	r mm	Weight kg	pakend	UOM
1030269	175/140	140-175	1200	12,000	9	tk
1030270	200	200	1000	17,000	9	tk

Uponor Ecoflex läbiviigukomplekt NPW

- Valubeton või kiviseinale
- NWP = mitte survele vee isoleerimiseks
- Komplektis PE toru ja kuumahenev käis

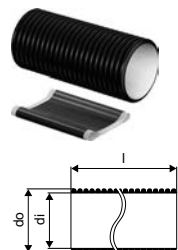

Art. nr.	Dimension	l mm	di mm	do mm	Weight kg	pakend	UOM
1018267	68+90	550	95	110	1,000	1	tk

Uponor Ecoflex

Uponor Ecoflex paranduskäis

- Kuumahenev lint kaitsekesta kahjustuste kõrvaldamiseks

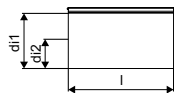

Art. nr.	Dimension	l mm	di1 mm	di2 mm	s mm	Weight kg	pakend	UOM
1036014	140+145+175+200-700mm	700	226	98	1,7	1,200	1	tk

Uponor Ecoflex hoiatuslint punane

- Paigaldatud Ecoflex torude asukoha markeerimiseks
- Lindi markeering vastavalt nõuetele

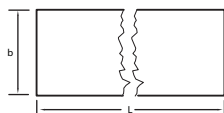

Art. nr.	Dimension	L m	b mm	Weight kg	pakend	UOM
1018385	40mm x 250m	250	40	2,000	1	tk

Uponor ventilatsiooni torustikud

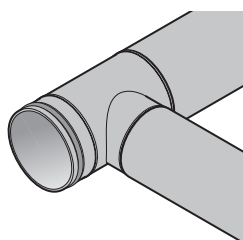

Uponor ventilatsioonisüsteem on hügieeniline ja lõhnatu lahendus korteripõhise või eramu ventilatsiooni ehitamiseks. Patenteeritud ühendussüsteem lihtsustab paigaldust.

Eelised

- Lihtne ja kiire paigaldus
- Püsivalt antistaatiline
- Väikesed energiakaod
- Ei vaja eri tööriistu
- Täielik valik liitmikke



Kirjeldus

- Tooraine lõhnatu ja mittetoksiiline polüpropüleen
- Antistaatiline
- Värvus must

Kasutusala

- Ventilatsiooni torud ja liitmikud

Sertifitseerimine

- VTT sertifikaadid nr. 158/01 ja VTT-C-6220-10

Uponor Ventilation toru

- Kaitsekorkidega torud
- Sisepind püsivalt antistaatiline
- Patenteeritud välispind antistaatiline 2 aastat peale tootmist, et vältida torude määrdumist ladustamisel ja paigaldamisel

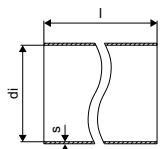

Art. nr.	Dimension	l mm	di mm	s mm	pakend	UOM
1068037	100mm 3m	3000	100	2,0	50	tk
1068038	125mm 3m	3000	125	2,0	32	tk
1068039	160mm 3m	3000	160	3,0	18	tk
1068040	200mm 3m	3000	200	3,0	20	tk

Uponor Ventilation põlv

- Patenteeritud ühendusmeetod, tihedusklass D
- Pakitud individuaalsesse hügieenilisse pakendisse
- Püsivalt antistaatiline

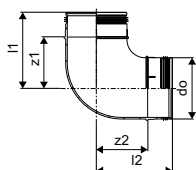

Art. nr.	Dimension	l1 mm	l2 mm	do mm	z1 mm	z2 mm	α	2. pak.	pakend	UOM
1068053	100X90°	124	124	100	84	84	90°	10	1	tk
1068054	125X90°	163	163	125	113	113	90°	10	1	tk
1068055	160X90°	213	213	160	163	163	90°	6	1	tk
1068052	200X90°	180	180	199	130	130	90°	4	1	tk

Uponor ventilatsiooni torustikud

Uponor Ventilation põlv

- Patenteeritud ühendusmeetod, tihedusklass D
- Pakitud individuaalsesse hügieenilisse pakendisse
- Püsivalt antistaatiline

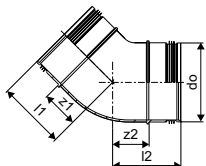

Art. nr.	Dimension	l1 mm	l2 mm	do mm	z1 mm	z2 mm	α	2. pak.	pakend	UOM
1068057	100X45°	86	86	100	46	46	45°	11	1	tk
1068058	125X45°	86	86	125	36	36	45°	14	1	tk
1068059	160X45°	95	95	160	45	45	45°	12	1	tk
1068056	200X45°	103	103	199	53	53	45°	8	1	tk

Uponor Ventilation kolmik

- Patenteeritud ühendusmeetod, tihedusklass D
- Pakitud individuaalsesse hügieenilisse pakendisse
- Püsivalt antistaatiline

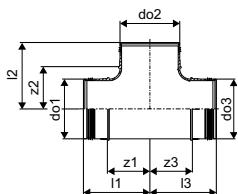

Art. nr.	Dimension	l1 mm	l2 mm	l3 mm	do1 mm	do2 mm	do3 mm	z1 mm	z2 mm	z3 mm	2. pak.	pakend	UOM
1068060	100/100X90°	111	111	111	99	99	100	71	71	71	15	1	tk
1068064	125/100X90°	122	124	122	124	99	125	72	74	72	15	1	tk
1068061	125/125X90°	134	134	134	124	124	125	84	84	84	10	1	tk
1068065	160/100X90°	122	141	122	159	99	159	72	91	72	10	1	tk
1068062	160/125X90°	134	151	134	160	125	160	84	101	84	7	1	tk
1068063	160/160X90°	151	151	151	159	159	159	101	101	101	6	1	tk
1068066	200/160X90°	151	171	151	199	159	199	101	121	101	5	1	tk

Uponor Ventilation jätk

- Patenteeritud ühendusmeetod, tihedusklass D
- Pakitud individuaalsesse hügieenilisse pakendisse
- Püsivalt antistaatiline

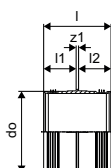

Art. nr.	Dimension	l mm	l1 mm	l2 mm	do mm	z1 mm	2. pak.	pakend	UOM
1068049	100mm	83	40	40	100	3	20	1	tk
1068050	125mm	103	50	50	125	3	30	1	tk
1068051	160mm	103	50	50	160	3	15	1	tk
1068048	200mm	103	50	50	200	3	12	1	tk

Uponor ventilatsiooni torustikud

Uponor Ventilation kork

- Patenteeritud ühendusmeetod, tihedusklass D
- Pakitud individuaalsesse hügieenilisse pakendisse
- Püsivalt antistaatiline

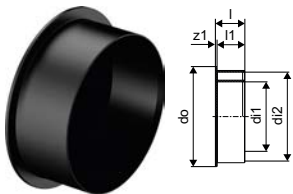

Art. nr.	Dimension	l mm	l1 mm	di1 mm	di2 mm	do mm	s mm	z1 mm	2. pak.	pakend	UOM
1068067	100mm	43	40	100		120	2,2	3	20	1	tk
1068068	125mm	33	30	125		145	2,2	3	40	1	tk
1068069	160/125mm	53	50	125	160	180	2,8	3	30	1	tk

Uponor Ventilation siirdmik

- Patenteeritud ühendusmeetod, tihedusklass D
- Pakitud individuaalsesse hügieenilisse pakendisse
- Püsivalt antistaatiline

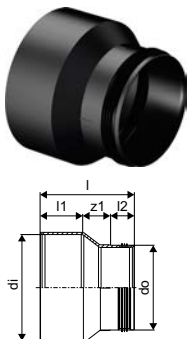

Art. nr.	Dimension	l mm	l1 mm	l2 mm	di mm	do mm	z1 mm	2. pak.	pakend	UOM
1068070	125-100mm	111	50	30	125	100	33	12	1	tk
1068071	160-125mm	131	50	33	160	125	48	15	1	tk
1068072	200-160mm	141	50	33	200	160	59	12	1	tk

Uponor Ventilation Flex põlv

- Gofreeritud keskosaga torulõik
- Võimaldab paindenurki 0-45 ja 0-90 kraadi

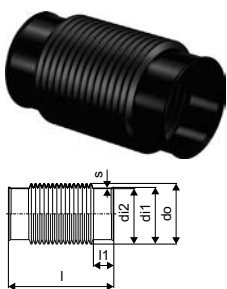

Art. nr.	Dimension	l mm	l1 mm	di1 mm	di2 mm	do mm	s mm	2. pak.	pakend	UOM
1061401	125 0-45	262	52	131	125	150	1,5	12	1	tk
1061402	125 0-90	419	52	131	125	150	1,5	8	1	tk
1061403	160 0-45	334	52	166	160	197,2	2,0	6	1	tk
1061404	160 0-90	563	52	166	160	197,2	2,0	4	1	tk

Uponor isoleeritud ventilatsiooni torustikud

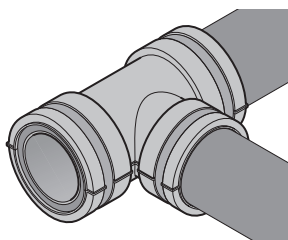

Uponor ventilatsioonisüsteem on hügieeniline ja lõhnatu lahendus korteripõhise või eramu ventilatsiooni ehitamiseks. Isolatsioon väldib kondensaadi tekkimise välispinnale. Patenteeritud ühendussüsteem lihtsustab

paigaldust.

Eelised

- Lihtne ja kiire paigaldus
- Püsivalt antistaatiline
- Väikesed energiakaod
- Ei vaja eri tööriistu
- Täielik valik liitmikke



Kirjeldus

- Tooraine lõhnatu ja mittetoksiline polüpropüleen
- Antistaatiline materjal
- Torude ja liitmike värvus must, isolatsioon hall
- Isolatsioon vahtpolüetüleen
- Isolatsiooni paksus 15mm

Kasutusala

- Kondensatsiooni kaitse isolatsiooniga kaetud ventilatsiooni torud ja liitmikud

Sertifitseerimine

- VTT sertifikaadid nr. 158/01 ja VTT-C-6220-10

Uponor Ventilation toru isoleeritud

- Kaitsekorkidega torud
- Sisepind püsivalt antistaatiline
- Patenteeritud välispind antistaatiline 2 aastat peale tootmist, et vältida torude määrdumist ladustamisel ja paigaldamisel

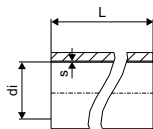

Art. nr.	Dimension	l mm	di mm	s mm	pakend	UOM
1068041	100mm 3m	3000	100	17,1	40	tk
1068042	125mm 3m	3000	125	17,1	28	tk
1068043	160mm 3m	3000	160	17,5	20	tk
1068044	200mm 3m	3000	200	18,0	20	tk

Uponor isoleeritud ventilatsiooni torustikud

Uponor Ventilation põlv isoleeritud

- Patenteeritud ühendusmeetod, tihedusklass D
- Pakitud individuaalsesse hügieenilisse pakendisse
- Püsivalt antistaatiline
- Iga liitmik varustatud vajaliku arvu pingutitega

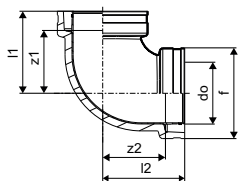

Art. nr.	Dimension	l1 mm	l2 mm	do mm	z1 mm	z2 mm	f mm	α	2. pak.	pakend	UOM
1068078	100 X 90°	124	124	100	84	84	170	90°	10	1	tk
1068079	125 X 90°	163	163	125	113	113	195	90°	7	1	tk
1068080	160 X 90°	213	213	160	163	163	230	90°	8	1	tk
1068077	200 X 90°	180	180	199	130	130	270	90°	6	1	tk

Uponor Ventilation põlv isoleeritud

- Patenteeritud ühendusmeetod, tihedusklass D
- Pakitud individuaalsesse hügieenilisse pakendisse
- Püsivalt antistaatiline
- Iga liitmik varustatud vajaliku arvu pingutitega

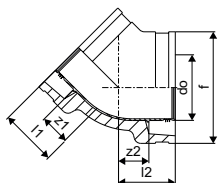

Art. nr.	Dimension	l1 mm	l2 mm	do mm	z1 mm	z2 mm	f mm	α	2. pak.	pakend	UOM
1068082	100 X 45°	86	86	100	46	46	169	45°	10	1	tk
1068083	125 X 45°	86	86	125	36	36	195	45°	6	1	tk
1068084	160 X 45°	95	95	160	45	45	230	45°	6	1	tk
1068081	200 X 45°	103	103	199	53	53	269	45°	10	1	tk

Uponor Ventilation kolmik isoleeritud

- Patenteeritud ühendusmeetod, tihedusklass D
- Pakitud individuaalsesse hügieenilisse pakendisse
- Püsivalt antistaatiline
- Iga liitmik varustatud vajaliku arvu pingutitega

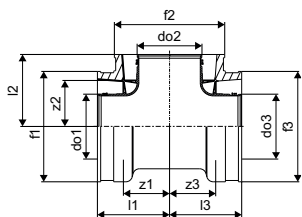

Art. nr.	Dimension	l1 mm	l2 mm	l3 mm	do1 mm	do2 mm	do3 mm	z1 mm	z2 mm	z3 mm	f mm	g mm	2. pak.	pakend	UOM
1068085	100/100X90°	111	111	111	99	99	100	71	71	71	170	8	1	tk	
1068086	125/125X90°	122	124	122	124	99	125	72	74	72	195	10	1	tk	
1068087	160/125X90°	134	134	134	124	124	125	84	84	84	230	195	10	1	tk
1068088	160/160X90°	122	141	122	159	99	159	72	91	72	230	10	1	tk	
1068089	125/100X90°	134	151	134	160	125	160	84	101	84	195	170	8	1	tk
1068090	160/100X90°	151	151	151	159	159	159	101	101	101	230	170	10	1	tk
1068091	200/160X90°	151	171	151	199	159	199	101	121	101	270	230	5	1	tk

Uponor isoleeritud ventilatsiooni torustikud

Uponor Ventilation jätk isoleeritud

- Patenteeritud ühendusmeetod, tihedusklass D
- Pakitud individuaalsesse hügieenilisse pakendisse
- Püsivalt antistaatiline
- Iga liitmik varustatud vajaliku arvu pingutitega

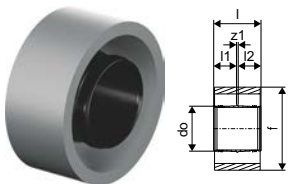

Art. nr.	Dimension	l mm	l1 mm	l2 mm	do mm	z1 mm	2. pak.	pakend	UOM
1068074	100mm	83	40	40	100	3	9	1	tk
1068075	125mm	103	50	50	125	3	10	1	tk
1068076	160mm	103	50	50	160	3	9	1	tk
1068073	200mm	103	50	50	200	3	10	1	tk

Uponor Ventilation kork isoleeritud

- Patenteeritud ühendusmeetod, tihedusklass D
- Pakitud individuaalsesse hügieenilisse pakendisse
- Püsivalt antistaatiline
- Iga liitmik varustatud vajaliku arvu pingutitega

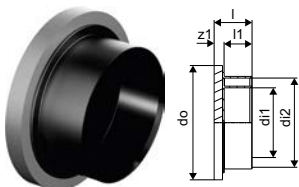

Art. nr.	Dimension	l mm	l1 mm	di1 mm	di2 mm	do mm	do1 mm	do2 mm	s mm	s2 mm	z1 mm	2. pak.	pakend	UOM
1068092	100mm	58	40	100		140	25	48	2,0	10,0	18	10	1	tk
1068093	125mm	48	30	125		165			2,0		18	6	1	tk
1068094	160/125mm	68	50	125	160	205			2,0		18	10	1	tk

Uponor Ventilation siirdmik isoleeritud

- Patenteeritud ühendusmeetod, tihedusklass D
- Pakitud individuaalsesse hügieenilisse pakendisse
- Püsivalt antistaatiline
- Iga liitmik varustatud vajaliku arvu pingutitega

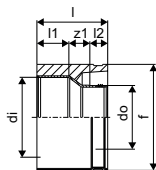

Art. nr.	Dimension	l mm	l1 mm	l2 mm	di mm	do mm	z1 mm	f mm	2. pak.	pakend	UOM
1068095	125-100mm	111	48	30	125	100	33	160	10	1	tk
1068096	160-125mm	131	50	33	160	125	48	206	8	1	tk
1068097	200-160mm	141	49	33	200	160	59	246	8	1	tk

Uponor Combi Port

Uponor Combi Port

Kirjeldus

- Täielikult eelkoostatud ja survetestitud sõlm
- Tehnilised piirangud tootelehtedel
- Plastist toru kinnitusklaamid müra summutamiseks ja soojuskadude vähendamiseks
- DVGW sertifitseeritud PM klapp
- Vahetükk soojusmõõtjale
- Potentsiaali ühtlustamise ühenduse võimalus (markeeritud)
- max kütte töö rõhk: PN10
- max tarbevee töö rõhk: PN10
- max töötemperatuur: 85 °C
- max kütte rõhkude vahe: 2,5 bar
- min. tarbevee rõhk: 2,0 bar
- Tarbevee liitmike materjal: CW617N
- Kütte liitmike materjal: CW617N, CW614N
- Toru materjal: roostevaba teras 1.4401

Uponor Combi Port B 1000 B 1000 UFH/RC

- Külma vee sisendil vahetükk veemõõtja paigaldamiseks
- Termostaatiline möödaviik klapp
- Primaarpoole diferentsiaalrõhu juhtimine
- Põrandkütte segamissõlm, 3-punkti ajam, komplektis ohutustemperatuuri piiraja
- Teine, segamiseta kütteväljund
- Tühjenduskomplekt
- Sooja tarbevee temperatuuri piiraja
- Soojusmõõtja
- Külma vee mõõtja
- Smatrix Move
- Smatrix Wave
- Smart S kollektor 5 kontuurile koos ajamitega
- Joodetud vasest plaatsoojusvaheti
- Õhueraldi
- Külma vee filter 0,5 mm
- Primaarpoole kütte pealevoolu filter HZ-VL-PR 0,5 mm
- Sekundaarpoole kütte tsooni ventiil: Kvs 0,06-0,9
- Mõõtmed: L/K/S 610 x 1.200 x 150 mm



Art. nr.	Dimension	b mm	h mm	d mm	Weight kg	pakend	UOM
1089500*	19 l/min 5L	610	1200	150	32,000	1	tk

Uponor Combi Port

Uponor Combi Port B 1000 B 1000 H/C

- Külma vee sisend vahetükiga veemõõtja paigaldamiseks
- Termostaatiline möödaviikkapp
- Primaarpoole diferentsiaalrõhu juhtimine
- Põrandkütte segamissõlm, 3-punkti ajam, komplektis ohutustemperatuuri piiraja
- Sooja tarbevee temperatuuri piiraja
- Soojusmõõtja
- Külma vee mõõtja
- Tühjenduskomplekt
- Jahutusmoodul koos diferentsiaalrõhu juhtimisega
- Jahutusenergia mõõtja
- Smatrix Wave
- Smatrix Move PLUS
- Vario M kollektor 8 kontuurile koos ajamitega
- Seinapealne kapp koos raami ja uksega RAL 9016
- Joodetud vasest plaatsoojusvaheti
- Tehnilised piirangud tootelehel
- Õhu eraldaja
- Külma vee filter 0,5 mm
- Kütte primaarpoole pealevoolu filter HZ-VL-PR 0,5 mm
- Sekundaarpoole küttekontuuri tsooni ventiil: Kvs 0,06-0,9;
- Mõõtmed: L/K/S 810 x 1.200 x 150 mm



Art. nr.	Dimension	b mm	h mm	d mm	Weight kg	pakend	UOM
1089499*	19 l/min 8L	810	1200	150	30,000	1	tk

Uponor Combi Port B 1000 B 1000 HY UFH

- Külma vee sisend vahetükiga veemõõtja paigaldamiseks
- Termostaatiline möödaviikkapp
- Sekundaarpoole diferentsiaalrõhu juhtimine
- Tühjenduskomplekt
- Vahetükk soojusmõõtjale
- Joodetud vasest plaatsoojusvaheti
- Õhueraldaja
- Külma vee filter 0,5 mm
- Kütte primaarpoole pealevoolu filter HZ-VL-PR 0,5 mm
- Sekundaarpoole küttekontuuri tsooniventil: Kvs 0,06-0,9;
- max. töötemperatuur: 60 °C
- max. kütte rõhkude vahe: 2,5 bar
- min. tarbevee rõhk: 3 bar
- Mõõtmed: L/K/S 556 x 620 x 145 mm



Art. nr.	Dimension	b mm	h mm	d mm	Weight kg	pakend	UOM
1089501	15 l/min 13kW	556	620	145	23,000	1	tk
1089502	17 l/min 21kW	556	620	145	23,000	1	tk

Uponor Combi Port

Uponor Combi Port T 1000 T 1000 RC

- Termostaatiline möödaviiguventiil
- Primaarpoole diferentsiaalrõhu juhtimine
- Tühjenduskomplekt
- Vahetükk soojusmõõtjale
- Joodetud vasest plaatsoojusvaheti
- Õhueraldaja
- Külma vee filter 0,5 mm
- Kütte primaarpoole pealevoolu filter HZ-VL-PR 0,5 mm
- Sekundaarpoole küttekontuuri tsooniventiiil: Kvs 0,06-0,9;
- Mõõtmed: L/K/S 436 x 690 x 125 mm



Art. nr.	Dimension	b mm	h mm	d mm	Weight kg		pakend	UOM
1089503	15 l/min	436	690	125	15,700		1	tk

Uponor Combi Port PRO RC



Art. nr.	Dimension	l mm	l1 mm	b mm	h mm	h1 mm	w mm	w1 mm	2. pak.	pakend	UOM
1093769	15l/min	556	83	65	108	65	618	600	16	1	tk
1093777	VA 15l/min	556	83	65	108	65	618	600	16	1	tk
1093773	19l/min	556	83	65	108	65	618	600	16	1	tk
1093781	VA 19l/min	556	83	65	108	65	618	600	16	1	tk

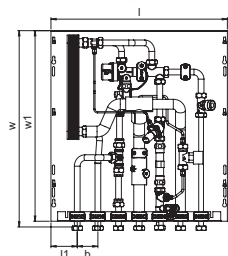

Uponor Combi Port PRO RC TWB



Art. nr.	Dimension	l mm	l1 mm	b mm	h mm	h1 mm	w mm	w1 mm	2. pak.	pakend	UOM
1093770	15l/min	556	83	65	108	35	618	600	16	1	tk
1093778	VA 15l/min	556	83	65	108	35	618	600	16	1	tk
1093774	19l/min	556	83	65	108	35	618	600	16	1	tk
1093782	VA 19l/min	556	83	65	108	35	618	600	16	1	tk

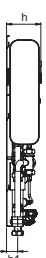
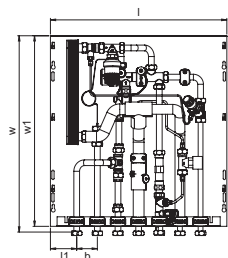

Uponor Combi Port

Uponor Combi Port PRO RC RTB



NEW
NEW
NEW
NEW

Art. nr.	Dimension	l mm	l1 mm	b mm	h mm	h1 mm	w mm	w1 mm	2. pak.	pakend	UOM
1093771	15l/min	556	83	65	108	35	618	600	16	1	tk
1093779	VA 15l/min	556	83	65	108	35	618	600	16	1	tk
1093775	19l/min	556	83	65	108	35	618	600	16	1	tk
1093783	VA 19l/min	556	83	65	108	35	618	600	16	1	tk

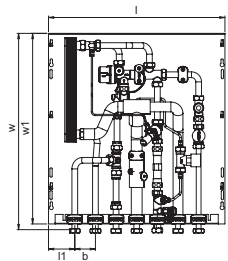

Uponor Combi Port PRO RC TWB RTB



NEW
NEW
NEW
NEW

Art. nr.	Dimension	l mm	l1 mm	b mm	h mm	h1 mm	w mm	w1 mm	2. pak.	pakend	UOM
1093772	15l/min	556	83	65	108	35	618	600	16	1	tk
1093780	VA 15l/min	556	83	65	108	35	618	600	16	1	tk
1093776	19l/min	556	83	65	108	35	618	600	16	1	tk
1093784	VA 19l/min	556	83	65	108	35	618	600	16	1	tk

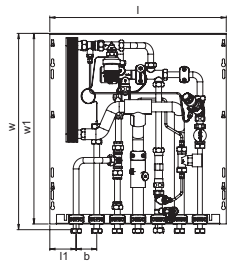

Uponor Combi Port PRO UFH



NEW
NEW
NEW
NEW

Art. nr.	Dimension	l mm	l1 mm	b mm	h mm	h1 mm	w mm	w1 mm	2. pak.	pakend	UOM
1093785	15l/min	556	83	65	107	35	618	600	16	1	tk
1093793	VA 15l/min	556	83	65	107	35	618	600	16	1	tk
1093789	19l/min	556	83	65	107	35	618	600	16	1	tk
1093797	VA 19l/min	556	83	65	107	35	618	600	16	1	tk

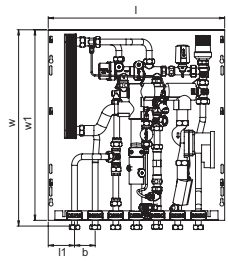

Uponor Combi Port

Uponor Combi Port PRO UFH TWB



NEW
NEW
NEW
NEW

Art. nr.	Dimension	l mm	l1 mm	b mm	h mm	h1 mm	w mm	w1 mm	2. pak.	pakend	UOM
1093787	15l/min	556	83	65	107	35	618	600	16	1	tk
1093795	VA 15l/min	556	83	65	107	35	618	600	16	1	tk
1093791	19l/min	556	83	65	107	35	618	600	16	1	tk
1093799	VA 19l/min	556	83	65	107	35	618	600	16	1	tk

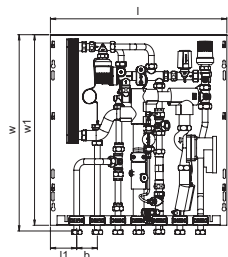

Uponor Combi Port PRO UFH 2.HC



NEW
NEW
NEW
NEW

Art. nr.	Dimension	l mm	l1 mm	b mm	b1 mm	h mm	h1 mm	w mm	w1 mm	2. pak.	pakend	UOM
1093786	15l/min	556	33	65	50	107	35	618	600	16	1	tk
1093794	VA 15l/min	556	33	65	50	107	35	618	600	16	1	tk
1093790	19l/min	556	33	65	50	107	35	618	600	16	1	tk
1093798	VA 19l/min	556	33	65	50	107	35	618	600	16	1	tk

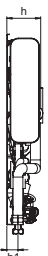
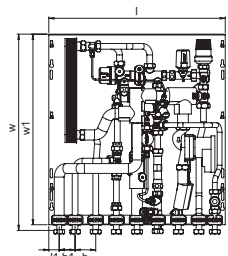

Uponor Combi Port PRO UFH 2.HC TWB



NEW
NEW
NEW
NEW

Art. nr.	Dimension	l mm	l1 mm	b mm	b1 mm	h mm	h1 mm	w mm	w1 mm	2. pak.	pakend	UOM
1093788	15l/min	556	33	65	50	107	35	618	600	16	1	tk
1093796	VA 15l/min	556	33	65	50	107	35	618	600	16	1	tk
1093792	19l/min	556	33	65	50	107	35	618	600	16	1	tk
1093800	VA 19l/min	556	33	65	50	107	35	618	600	16	1	tk

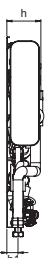
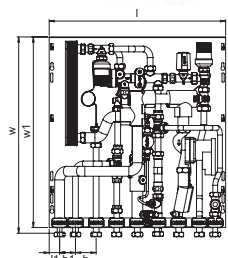

Uponor Combi Port

Uponor Combi Port Base



Art. nr.	Dimension	l mm	l1 mm	b mm	h mm	h1 mm	w mm	w1 mm	2. pak.	pakend	UOM
1093801	15l/min	556	83	65	107	35	618	600	16	1	tk
1093803	VA 15l/min	556	83	65	107	35	618	600	16	1	tk
1093805	19l/min	556	83	65	107	35	618	600	16	1	tk
1093807	VA 19l/min	556	83	65	107	35	618	600	16	1	tk

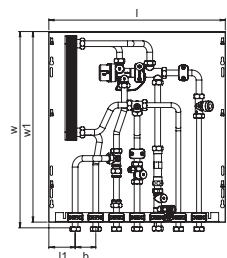

Uponor Combi Port Base TWB



Art. nr.	Dimension	l mm	l1 mm	b mm	h mm	h1 mm	w mm	w1 mm	2. pak.	pakend	UOM
1093802	15l/min	556	83	65	107	35	618	600	16	1	tk
1093804	VA 15l/min	556	83	65	107	35	618	600	16	1	tk
1093806	19l/min	556	83	65	107	35	618	600	16	1	tk
1093808	VA 19l/min	556	83	65	107	35	618	600	16	1	tk

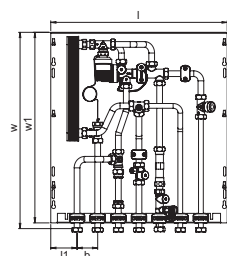

Uponor Aqua Port

Uponor Aqua Port

Kirjeldus

- Täielikult eelkoostatud ja survetestitud sõlm
- Tehnilised piirangud tootelehtedel
- Plastist toru kinnitusklaamid müra summutamiseks ja soojuskadude vähendamiseks
- DVGW sertifitseeritud PM klapp
- Vahetükk soojusmõõtjale
- Potentsiaali ühtlustamise ühenduse võimalus (markeeritud)
- max kütte töö rõhk: PN10
- max tarbevee töö rõhk: PN10
- max töötemperatuur: 85 °C
- max kütte rõhkude vahe: 2,5 bar
- min. tarbevee rõhk: 2,0 bar
- Tarbevee liitmike materjal: CW617N
- Kütte liitmike materjal: CW617N, CW614N
- Toru materjal: roostevaba teras 1.4401

Uponor Aqua Port S 1000 S 1000

- Primaarpoole diferentsiaalrõhu juhtimine
- Termostaatiline möödviiguventiil
- Joodetud vasest plaatsoojusvaheti
- Õhueraldaja
- Külma vee filter 0,5 mm
- Primaarpoole kütte pealevoolu filter HZ-VL-PR 0,5 mm
- Külma vee sisend vahetükiga veemõõtja paigaldamiseks
- Mõõtmed: L/K/S 436 x 620 x 145 mm



Art. nr.	Dimension	b mm	h mm	d mm	Weight kg	pakend	UOM
1089517*	12 l/min	436	620	145	14,500	1	tk
1089518*	15 l/min	436	620	145	15,000	1	tk
1089519*	17 l/min	436	620	145	16,400	1	tk
1089520*	20 l/min	436	620	145	17,800	1	tk

Uponor Aqua Port Central

Uponor Aqua Port Central

Kirjeldus

- õ odetud vasest plaatsoojusvaheti
- Suure efektiivsusega pump
- Kuulkraanid kütte ühendusteks
- Sulgventiilid külma tarbevee sisendil
- Plastist toru kinnitusklambrid müra ja soojuskadude vähendamiseks
- Täielikult koostatud ja survetestitud sõlm
- Potentsiaaliühtlustuse ühenduse võimalus (markeeritud)
- Tarbevee liitmike materjal: CW617N
- Kütte liitmike materjal: CW617N, CW614N
- Torude materjal: roostevaba teras 1.4401
- max kütte töö rõhk: PN10
- max tarbevee töö rõhk: PN10
- max töötemperatuur: 85 °C
- Toitepinge: 230 V/50 Hz

Uponor Aqua Port Central 100 100

- DVGW sertifitseeritud PM klapp
- Sooja tarbevee segisti 45°C-65°C
- Kogu sõlm kaetud EPP isolatsiooniga
- Mõõtmed: L/K/S 450 x 700 x 283 mm
- Tootekood 1089526, komplektis tsirkulatsioonimoodul



Art. nr.	Dimension	b mm	h mm	d mm	Weight kg	pakend	UOM
1089525	22 l/min	450	890	283	18,800	1	tk
1089526	22 l/min C	450	970	283	19,100	1	tk

Uponor Aqua Port Central 200 200

- Elektronilise juhtimisega sõlm sooja tarbevee valmistamiseks
- Komplektis tsirkulatsioonimoodul
- Sõlm täielikult kaetud EPP isolatsiooniga
- Mõõtmed: L/K/S 450 x 700 x 283 mm



Art. nr.	Dimension	b mm	h mm	d mm	Weight kg	pakend	UOM
1089527	25 l/min C	450	970	283	22,000	1	tk
1089528	45 l/min C	450	1030	283	28,500	1	tk
1089529	60 l/min C	450	1090	283	35,400	1	tk

Uponor Aqua Port Central

Uponor Aqua Port Central 500 500

- Elektroonilise juhtimisega sõlm sooja tarbevee valmistamiseks
- Komplektis tsirkulatsioonimoodul
- Metallkate, valge RAL9016
- Mõõtmed: L/K/S 720 x 1090 x 550 mm



Art. nr.	Dimension	b mm	h mm	d mm	Weight kg	pakend	UOM
1089530	75 l/min C	720	1190	550	95,000	1	tk
1089531	100 l/min C	720	1190	550	105,000	1	tk

Kerilaud, torusirgesti

Uponor MLC torusirgesti

- Toru sirgesti ei ole seotud Uponor kerilauaga



Art. nr.	Dimension	pakend	UOM
1010512	14-25	1	tk

Uponor Magna kerilaud juhikuga



Art. nr.	2. pak.	pakend	UOM
1035807	4	1	tk

Uponor Wipex klambervöö tangid

- WIPEX liitmiku klambervöö avamiseks



Art. nr.	Dimension	l mm	Weight kg	2. pak.	pakend	UOM
1046407	1 - 1 1/2	145	0,148	25	1	tk
1046408	1 1/2 - 3 1/2	200	0,228	25	1	tk

Torulõikurid, kalibreerijad, painutusvedrud

Uponor Multi toru ja hülsi lõikur

- Kolmnurkse teraga torulõikur
- välisläbimõõdule 12-25 mm



Art. nr.	Dimension	2. pak.	pakend	UOM
1089674	12-25	36	1	tk
1089776	12-25	varutera	1	tk

Uponor Multi torulõikur

- välisläbimõõdule 25 - 63 mm



NEW

NEW

Art. nr.	Dimension	2. pak.	pakend	UOM
1089675	25-63	12	1	tk
1089777	25-63	torulõikuri varutera	1	tk

Uponor Flex toru lõikur PEX

- Uponor PEX torude lõikamiseks, läbimõõtudele 12-25 mm. #Terad ei ühildu Uponor torulõikuriga 1001369



NEW

NEW

Art. nr.	Dimension	2. pak.	pakend	UOM
1089673	12-25	36	1	tk
1089780	12-25	varutera	1	tk

Uponor MLC torulõikur faasija



Art. nr.	Dimension	2. pak.	pakend	UOM
1014334	63-110	32	1	tk

Uponor MLC faasilõikur

- Uponor Uni Pipe PLUS ja MLC torude faasimiseks.
- Varustatud pööraga. Ilma pöörata kasutatav koos akudrelliga.



Art. nr.	Dimension	pakend	UOM
1015762	32	1	tk

Uponor MLC faasilõikur



Art. nr.	Dimension	pakend	UOM
1006638	40	1	tk
1015808	50	1	tk
1014339	63	1	tk
1014344	75	1	tk

Torulõikurid, kalibreerijad, painutusvedrud

Uponor MLC faasilõikur

- Uponor Uni Pipe PLUS ja MLC torude faasimiseks.



Art. nr.	Dimension	2. pak.	pakend	UOM
1015739	16/20/25		1	tk

Uponor MLC universaalne faasija



Art. nr.	2. pak.	pakend	UOM
1060167	50	1	tk

Uponor MLC sise painutusvedru

- Uponor Uni Pipe PLUS ja MLC torude painutusvedru.



Art. nr.	Dimension	2. pak.	pakend	UOM
1013729	16		1	tk
1013734	20		1	tk
1013737	25	50	1	tk
1013739	32	40	1	tk

Uponor MLC välis painutusvedru

- Uponor Uni Pipe PLUS ja MLC torude painutusvedru.



Art. nr.	Dimension	2. pak.	pakend	UOM
1006639*	14		1	tk
1006640	16		1	tk
1013792	20	45	1	tk
1013794	25	45	1	tk

Uponor Uni Pipe PLUS toru painuti

- Uponor Uni Pipe PLUS torude painutamiseks, läbimõõdud kuni 32 mm.
- Painuti koos painutus segmentidega.



Art. nr.	Dimension	2. pak.	pakend	UOM
1071925*	16-32		1	tk

Torulõikurid, kalibreerijad, painutusvedrud

Uponor MLC toru painuti

- Uponor MLC torude painutamiseks, läbimõõdud kuni 32 mm.
- Painuti koos painutus segmentidega.



Art. nr.	Dimension	2. pak.	pakend	UOM
1013773*	16-32	48	1	tk

Uponor presstöörüistad

Uponor S-Press käsipress presspaledeta

- vahetatavate presspaledega
- Tarnitakse kohvris ilma presspaledeta



Art. nr.	Dimension	d mm	2. pak.	pakend	UOM
1015764	14-20	14-20		1	tk

Uponor S-Press presspaled käsipressile

- Vahetatavad presspaled käsipressile



Art. nr.	Dimension	d mm	2. pak.	pakend	UOM
1015776*	14	14	1	1	tk
1015777	16	16	50	1	tk
1015780	20	20	50	1	tk

Uponor S-Press akupress UP110 presspeadeta

- Tarnitakse kohvris koos aku ja laadijaga
- presspeadeta.
- Toruühendustele kuni 110 mm.

Tehnilised andmed:

- Lühike presstsükkel
- Pressimisjõud: lineaarne, ligikaudu 32 kN
- Aku mahtuvus: High-power Makita 3.0 Ah Li-Ion aku
- Laadimisaeg: 22 min
- Kaal koos akuga: ilma presspeata 3.5 kg
- Mõõtmed: 377 x 75 x 116 mm
- Pööratav: presspea hoidik pööratav ligikaudu 350°



Art. nr.	2. pak.	pakend	UOM
1083612	20	1	kompl.

Uponor SPI S-Press varuaku UP110

- Aku 18 V / 3,0 Ah, Li-Ion (54 Wh)
- Aku pinget: 18 V
- Aku mahtuvus: 3.0 Ah
- Laadimisaeg: SPI S-PRESS akulaadijaga: 22 min
- Aku tüüp: Li-Ion
- Kaal: 0,6 kg



Art. nr.	TP V	2. pak.	pakend	UOM
1083608*	18	12	1	tk

Uponor presstööriistad

Uponor S-Press elektripress presspeadeta UP75

- andmed:
- Kaal: 3.30 kg
- Toitepinge: 230 V AC / 50 Hz
- Nimivõimsus: 200 Watt
- Pressimisjõud: ca. 32 kN
- Pressimisaeg: ca. 7 sec.



Art. nr.	d mm	TP V	2. pak.	pakend	UOM
1007082	- 110	230	20	1	tk

Uponor S-Press presspea UPP1

- presspead Uponor MLC pressliitmikele



Art. nr.	Dimension	d mm	pakend	UOM
1007084	16	16	1	tk
1007086	20	20	1	tk
1007087	25	25	1	tk
1007088	32	32	1	tk

Uponor S-Press presspea UPP1

- presspead Uponor MLC pressliitmikele



Art. nr.	Dimension	d mm	pakend	UOM
1015768	40	40	1	tk
1015792	50	50	1	tk

Uponor S-Press pressmooduli korpus

- Presskorpus pressmoodulitele Uponor MLC pressliitmike 63 - 110 mm. Kasutatakse pressidega UP 110, UP 75 ja UP 75 EL



Art. nr.	Dimension	d mm	pakend	UOM
1046545	63-110	63-110	1	tk

Uponor S-Press pressmoodul

- Pressmoodul Uponor MLC pressliitmikele 63 - 110 mm, kasutatakse koos presskorpusega. Pressidele UP 110, UP 75 and UP 75 EL



Art. nr.	Dimension	d mm	pakend	UOM
1046541	63	63	1	tk
1046542	75	75	1	tk
1046543*	90	90	1	tk
1046544*	110	110	1	tk

Uponor presstöörüistad

Uponor S-Press akupress Mini2 KSP0 presspeadega

- Uponor S-Press akupress Mini², tarnitakse kohvris, komplektis aku, laadija ja presspead.
- Läbimõõtudele kuni 32 mm.

Tehnilised andmed:

- Pressimistsükli kestvus 3-4 sekundit
- Pressimisjõud: lineaarne, ligikaudu 15 kN
- Aku maht: High-power Makita 1.3 Ah Li-Ion aku (3.0 Ah lisavõimalus)
- Laadimisaeg: 1.5 Ah 15 min. 3.0 Ah 22 min
- Kaal koos akuga: ilma presspeadeta 1.7 kg
- Mõõtmed: 377 x 75 x 116 mm
- Pööratav: presspea hoidik pööratav ligikaudu 350°



Art. nr.	Dimension	2. pak.	pakend	UOM
1083586	16/20/25/32	30	1	kompl.

Uponor SPI S-Press Mini2 aku

- Aku 18 V / 1.5 Ah, Li-Ion (27 Wh)
- Aku pinge: 18 V
- Aku mahtuvus: 1.5 Ah
- Laadimisaeg: SPI S-PRESS akulaadija: 15 min
- Aku tüüp: Li-Ion
- Kaal: 0,4 kg



Art. nr.	TP V	2. pak.	pakend	UOM
1083605*	18	48	1	tk

Uponor SPI S-Press akulaadija

- Kiirlaadija 18V Li-Ion akudele, 230 V
- Laadimisaeg: 1.3 Ah 15 min,
3.0 Ah 22 min
- Toitepinge: 230 V AC
- Aku pinge: 18 V
- Kaal: 1,0 kg



Art. nr.	Dimension	TP V	pakend	UOM
1083610*	Mini2, UP110	230	1	tk

Uponor SPI S-Press aku Mini

- Aku: 9.6V, Uponor akupressile Mini KSP0.



Art. nr.	TP V	pakend	UOM
1015703*	9.6	1	tk

Uponor presstöörüistad

Uponor S-Press presspea Mini KSP0

■ Uponor presspead MLC Mini KSP0



Art. nr.	Dimension	d mm	2. pak.	pakend	UOM
1007091*	16	16	5	1	tk
1007093*	20	20	5	1	tk
1007094*	25	25	5	1	tk
1007095*	32	32	5	1	tk

PEX laiendustööriistad

Uponor Q&E käsilaiendi S3,2 S5,0



Art. nr.	Dimension	p bar	pakend	UOM
1004064	16/20/25	6+10	1	kompl.

Uponor Q&E laienduspea



Art. nr.	Dimension	Tüüp	d	s	p	pakend	UOM
		-	mm	mm	bar		
1004006	32x2,9	32x2.9	32	2,9	6	1	tk

Uponor Q&E laienduspea



Art. nr.	Dimension	Tüüp	d	s	p	pakend	UOM
		-	mm	mm	bar		
1004059	16x2,2	16x2.2	16	2,2	10	1	tk

Uponor Q&E akulaiendi laienduspeadega M12



Art. nr.	Dimension	p	stroke	pakend	UOM
		bar	mm		
1057166	16/20/25 6bar	6	14	1	kompl.
1057167	16/20/25 10bar	10	14	1	kompl.

Uponor Q&E laienduspea M12/M18



Art. nr.	Dimension	d	s	p	stroke	pakend	UOM
		mm	mm	bar	mm		
1057172	16x1,8/2,0/2,2	16	1,8/2,0/2,2	6+10	14/25	1	tk
1057173*	20x1,9/2,0	20	1,9/2,0	6	14/25	1	tk
1057174	20x2,8	20	2,8	10	14/25	1	tk
1057175	25x2,3	25	2,3	6	14/25	1	tk
1057176	25x3,5	25	3,5	10	14/25	1	tk
1057177	32x2,9	32	2,9	6	14/25	1	tk

Uponor Q&E varuaku M12



Art. nr.	Dimension	2. pak.	pakend	UOM
1061185	4Ah	12	1	tk

PEX laiendustööriistad

Uponor Q&E akulaiendi laienduspeadega M18 6bar



Art. nr.	Dimension	p bar	stroke mm	pakend	UOM
1063908	16/20/25/32	6	25	1	kompl.

Uponor Q&E akulaiendi laienduspeadega M18 10bar



Art. nr.	Dimension	p bar	stroke mm	pakend	UOM
1063909	16/20/25/H32	10	25	1	kompl.

Uponor Q&E laienduspea M18 H



Art. nr.	Dimension	d mm	s mm	p bar	stroke mm	pakend	UOM
1057182	32x2,9/4,4	32	2,9/4,4	6+10	25	1	tk
1057183	40x3,7	40	3,7	6	25	1	tk

Uponor Q&E akulaiendi M18 VLD PEX



Art. nr.	Dimension	stroke mm	pakend	UOM
1085099	40-75	56	1	tk

Uponor Q&E laienduspea VLD



Art. nr.	Dimension	d mm	s mm	p bar	stroke mm	pakend	UOM
1085095	40x3,7/5,5	40	3,7/5,5	6+10	56	1	tk
1085096	50x4,6/6,9	50	4,6/6,9	6+10	56	1	tk
1085097	63x5,8/8,6	63	5,8/8,6	6+10	56	1	tk
1085098	75x6,8/10,3	75	6,8/10,3	6+10	56	1	tk

PEX laiendustööriistad

Uponor SPI Q&E akulaiendi varuaku M18 PEX



Art. nr.	Dimension	pakend	UOM
1085100*	5,0Ah	1	tk

Uponor Q&E grafiitmääre



Art. nr.	Dimension	Weight kg	pakend	UOM
1008334	30g	0,030	20	tk

Kinnitustööriistad

Uponor Tacker klambripaigaldi

- Tacker klambripaigaldi
- kasutatakse koos Uponor Tacker klambritega



Art. nr.	Dimension	2. pak.	pakend	UOM
1002295	14-20mm l=700mm	32	1	tk

Uponor Multi sidumiskonks

- sidumistraadi sidumiseks torude kinnitamisel armatuurvõrgule



Art. nr.	pakend	UOM
1034533*	1	tk

Muud tööriistad

Uponor Smart Aqua PLUS põlve paigaldi M7

- Paigaldusabinõu



Art. nr.	Dimension	2. pak.	pakend	UOM
1062944	G1/2"MT	20	1	tk

Uponor Smart Aqua PLUS karbi frees M7

- Aqua Plus ühenduskarbi frees
- Karp freesitakse kuni 3 mm seinapinnast
- Kasutakse koos elektritrelliga



Art. nr.	2. pak.	pakend	UOM
1062950	25	1	tk

Uponor Vario PLUS ventiili võti

- Võti kollektori ventiilide vahetamiseks



Art. nr.	2. pak.	pakend	UOM
1009216	10	1	tk

Põrandaküttekollektorid ja ajamid

uponor

Kontrolli kollektori ja ajami sobivust

UPONOR VARIO M PLASTKOLLEKTORID EUROKOONUSLIITMIKUTEGA



	Uponor-nr	Väljundid
2x3/4 Euro	1085944	2
3x3/4 Euro	1085945	3
4x3/4 Euro	1085946	4
5x3/4 Euro	1085947	5
6x3/4 Euro	1085948	6
7x3/4 Euro	1085949	7
8x3/4 Euro	1085950	8
9x3/4 Euro	1085951	9
10x3/4 Euro	1085952	10
11x3/4 Euro	1086250	11
12x3/4 Euro	1086251	12

Uponor Vario - sulgventiil, sirge



	Uponor-nr
NP G1-G1	1059132

Uponor Vario -seadeventiil



	Uponor-nr
G1-Rp1	1005100

Tagasivoolu-ventiil



Uponor-nr
1085957

Vooluhulga regulaator



Uponor-nr
1085956

UPONOR VARIO SMART SURVELIITMIKUD



Eurokoonus

G3/4" FTE	Uponor-nr
14x2,0	1086580
16x2,0	1086582
20x2,0	1086583

UPONOR VARIO PEX -LIITMIKUD Eurokoonus



G3/4" FT EC	Uponor-nr
16x1,8 / 2,0	1086284
20x1,9 / 2,0	1086290

UPONOR VARIO S RST -KOLLEKTORID

Uponor Vario S -kollektor
Eurokoonus liitmikutega



	Uponor-nr	Väljundid
FM 2X3/4 Euro	1086538	2
FM 3x3/4 Euro	1086539	3
FM 4x3/4 Euro	1086540	4
FM 5x3/4 Euro	1086541	5
FM 6x3/4 Euro	1086542	6
FM 7X3/4 Euro	1086543	7
FM 8x3/4 Euro	1086544	8
FM 9x3/4 Euro	1086545	9
FM 10x3/4 Euro	1086546	10
FM 11x3/4 Euro	1086547	11
FM 12x3/4 Euro	1086548	12

Uponor Vario - sulgventiil, sirge



	Uponor-nr
NP G1-G1	1059132

Uponor Vario -seadeventiil



	Uponor-nr
G1-Rp1	1005100

Tagasivoolu-ventiil



Uponor-nr
1087609

Vooluhulga regulaator



Uponor-nr
1087608

UPONOR VARIO S JA M -AJAM 230 V JA 24 V



Vario S	Uponor-nr	Pinge V
230 V	1087763	230
24 V	1087778	24

UPONOR SMATRIX RETROFIT -AJAM 24 V

Ühendamiseks teiste tootjate kollektoritele



	Uponor-nr	Pinge V
A-XXX 24V, NC, 1W	1083575	24

Varuosad

UPONOR VARIO B -KOLLEKTORI VARUOSAD



Vario B -pealevoolu-ventiil WGF

Uponor-nr
1034556



Vario B -vooluhulga regulaator WGF

Uponor-nr
1009142



UPONOR VARIO B -AJAM



Uponor Vario B - toimilaite	Uponor-nr
PRO 1W NC 24 V	1090264
PRO 1W NC 230 V	1090265

UPONOR VARIO PLUS -KOLLEKTORI VARUOSAD

Uponor Vario PLUS -kollektor
Q&E-ühendus



Vooluhulga regulaator

Uponor-nr
1009217



Tagasivooluventiil

Uponor-nr
1005250



Peavooluventiil

Uponor-nr
1034523



UPONOR VARIO PLUS -AJAM PRO 1W NC



Uponor Vario PLUS - ajam	Uponor-nr
PRO 1W NC 24 V	1090262
PRO 1W NC 230 V	1090263

Push-12 pump

Uponor-nr
1095132



Push-23 pump

Uponor-nr
1059854



Push pumbagrupi termostaat

Uponor-nr
1063461



Kõik ühes rakenduses: Uponor PRO App

Tooteteave, paigaldusjuhendid, edasimüüjate info, kontaktid ja Uponor & More preemiaprogramm alati käepärast.

Lae alla või uuenda Uponor PRO rakendus:

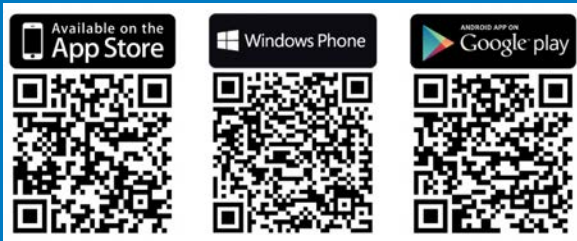

Uponor Eesti OÜ
Osmussaare 8
13811 Tallinn
Eesti

T +372 6 052 070
E uponor.estonia@uponor.com
04/2020

