

TABLETOP SOAP DISPENSER WP191-1



Ø 68 x 310 x 130 mm

chrome-plated brass

- Tabletop soap dispenser in chrome-plated brass.
- Solid body in brass; visible surfaces high-gloss chrome-plated.
- Design height: 62 mm
Outlet height: 37 mm
Projection: 74 mm
- Non-drip soap pump with 500 ml soap container and pressure valve in brass.
- Also available with 250 ml or 1000 ml containers.
- 500 ml container in stainless steel as an option for a surcharge.
- Designed for standard liquid soaps.
- Refillable from above by unscrewing the top part.
- Wear parts can be replaced as modules.
- Installation dimensions: Ø 22-26 mm, surface thickness max. 40 mm.
- Mounting: With one counternut.
- Delivery includes fixing material.
- Weight, including single package: 0.7 kg



Suggested text for specifications:

Tabletop soap dispenser in chrome-plated brass for counter mounting. Solid body in brass; visible surfaces high-gloss chrome-plated. Non-drip soap pump with 500 ml soap container and pressure valve in brass. Designed for standard liquid soaps. Refillable from above by unscrewing the top part. Delivery includes fixing material.

Dimensions: (with container) 65 x 310 x 130 mm

Design height: 62 mm

Outlet height: 37 mm

Projection: 74 mm

Article No. WP191-1

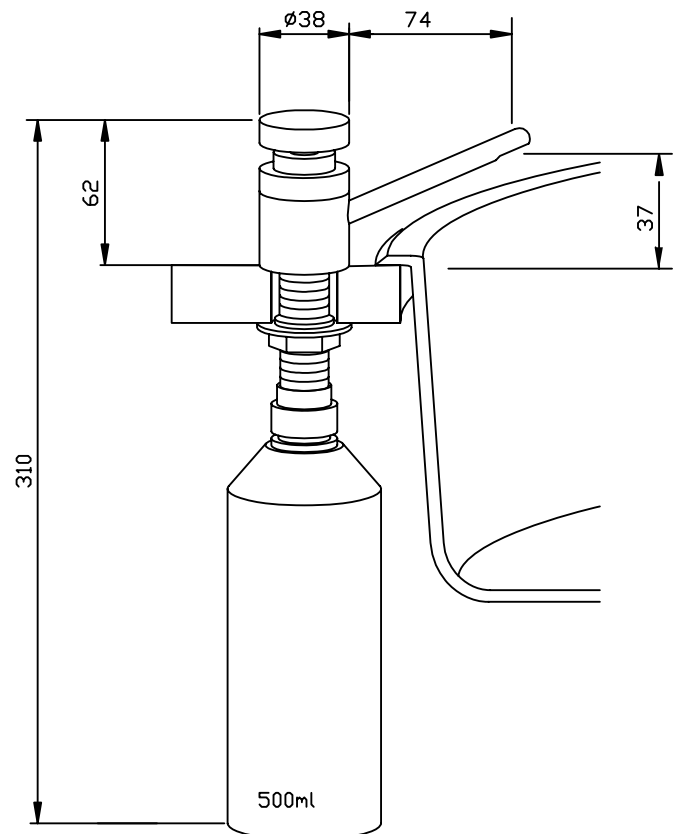

Options	ID No.
Washer / rosette	923 160

Available surface	ID No.
chrome-plated	923 942

Ernst Wagner GmbH & Co. KG

Ernst-Abbe-Straße 21 · D-72770 Reutlingen · Tel.: +49712151539-0 · Fax: -20
info@wagner-ewar.de · www.wagner-ewar.de

WAGNER
EWAR