

DISINFECTANT DISPENSER WP121



93 x 290 x 225 mm

1000 ml bottle disinfectant

- Disinfectant dispenser in robust, germ-reducing and easy-care stainless steel (AISI 304).
- Half-open stainless steel housing; visible surfaces satin finished and brushed.
- Elbow-operated disinfectant pump, can be set to different levels and autoclaved.
- Designed for standard 1000 ml disposable bottles of disinfectant.
- Accessible for refilling from the front side. Lockable cover plate in stainless steel as an option for a surcharge.
- Further accessories for a surcharge: drip tray
- Wear parts can be replaced as modules.
- Mounting: With three screws through holes in the back wall.
- Delivery includes fixing material.
- Weight, including single package: 1.2 kg



Suggested text for specifications:

Disinfectant dispenser in stainless steel (AISI 304) for surface mounting. Half-open stainless steel housing; visible surfaces satin finished and brushed. Elbow-operated disinfectant pump, can be set to different levels and autoclaved. Designed for standard 1000 ml disposable bottles of disinfectant. Accessible for refilling from the front side. Lockable cover plate in stainless steel as an option. Delivery includes fixing material.

Dimensions: 93 x 290 x 225 mm

Article No. WP121

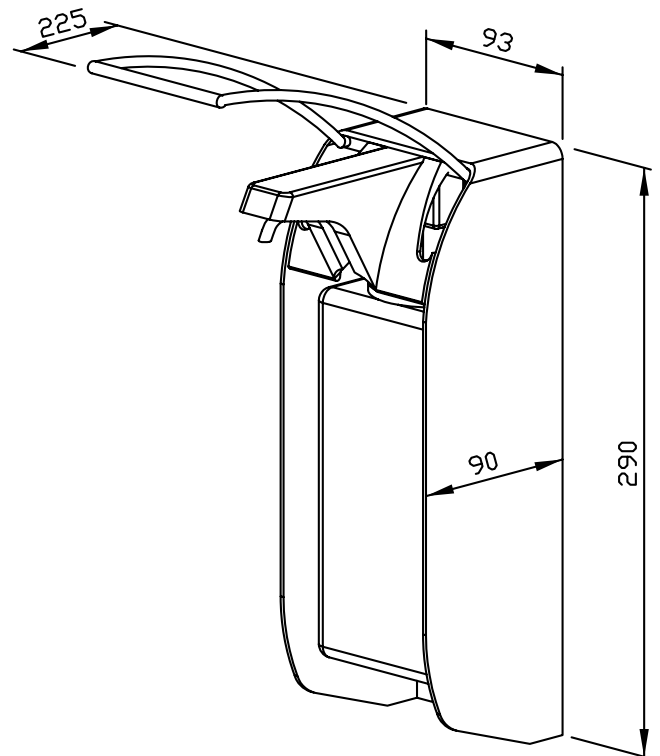

Options	ID No.
Lockable cover plate in stainless steel.	727 133
Drip tray	727 131

Available surface	ID No.
satin finished	727 121

Ernst Wagner GmbH & Co. KG

Ernst-Abbe-Straße 21 · D-72770 Reutlingen · Tel.: +49712151539-0 · Fax: -20
info@wagner-ewar.de · www.wagner-ewar.de

WAGNER
EWAR