

Spare parts 2023/24

Sanitary

SPARE PARTS

Tumblers	2 – 3
Soap dishes	3
Soap and disinfectant dispensers	4 – 9
Shelves	10 – 11
Walking aid holder, hooks	12
Mirrors	13
Waste bins, paper towel dispensers	14 – 15
Toilet brush units, toilet roll holder	16 – 19

Hinged support rails, backrests	20 – 23
Shower head holders, curtain rings	24 – 26
Roses	27 – 29
Seats	30 – 31
S 50 Height-adjustable modules	32 – 34
Fittings	35 – 41
Washbasins	42



Item Number

Dimensions in mm / Specification

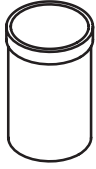

800.04.010

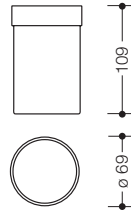

HEWI Tumbler

suitable for holder 800.00.10090 and 162.04.110..., product set 800.04.11041 and shelf with hole 950.13.00...

- cylindrical tumbler with flat bottom, \varnothing 69 mm, 109 mm high
- made of high-quality polyamide in 16 HEWI colours

800.04B010

suitable for product set 900.04.00060, holder 162.04.11060 and shelf with hole 950.13.00...

- do., made of high-quality matt polyamide in HEWI colours 98 (signal white) and 90 (jet black)

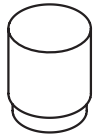

100.04.E01

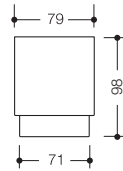

HEWI Glass tumbler

suitable for holder with tumbler 100.04.12145, 950.04.10045, 900Q04.000...

- \varnothing 79 mm, 98 mm high
- made of high-quality, satin-finished crystal glass

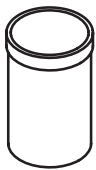

800.04.E01

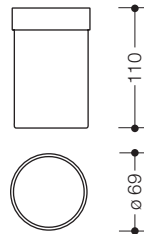

HEWI Glass tumbler

suitable for holder with tumbler 800.04.11045, 162.04.110540, 162.04.1105XA, 815.04.11..., 900.04.000...

- \varnothing 69 mm, 110 mm high
- made of high-quality, satin-finished crystal glass

Item Number

Dimensions in mm / Specification

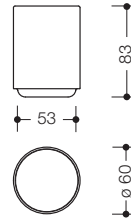
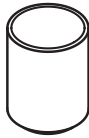

HEWI Tumbler
for cloakroom rails 33...PB8 with picto-set and
tumbler rack 800.03.4.../ 800.03B4...

- ø 60 mm, 83 mm high
- made of high-quality polyamide in 16 HEWI colours
- made of high-quality matt polyamide in 16 HEWI colours

41382
72320

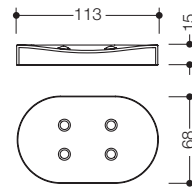

HEWI Soap dish

- rotatable soap dish, can sit flush with the holder or be used as a dish
- 113 mm wide, 15 mm high and 68 mm deep

800.02.E01

suitable for holder with soap dish 800.02.11045

- made of high-quality, satin-finished crystal glass

800.02.010

suitable for holder 800.02.10090 and product set 800.02.11041

- made of high-quality polyamide in 16 HEWI colours, please advise, colour when ordering

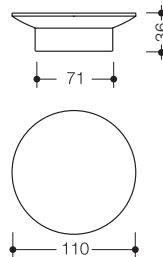

HEWI Soap dish

suitable for holder with soap dish 100.02.11145 and 950.02.10045

- ø 110 mm, 36 mm high
- made of high-quality, satin-finished crystal glass

62523

Item Number

Dimensions in mm / Specification

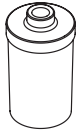

815.06.E01

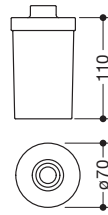

HEWI Glass container
for soap dispenser with holder 815.06.11... and 900.06.000...
· made of high-quality, satin-finished glass

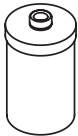

800.06.E02
67738

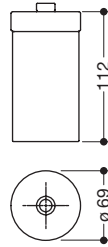

HEWI Container
for soap dispenser 800.06.010 and product sets 800.06.11041,
162.06.110..., 162.06.119..., 900.06.001...
· ø 69 mm, 112 mm high

· made of high-quality polyamide in 16 HEWI colours
· made of high-quality matt polyamide in HEWI colours 99 (pure white),
98 (signal white), 97 (light grey), 95 (stone grey), 92 (anthracite grey)
and 90 (jet black)

Please advise colour when ordering.

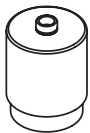

100.06.E01

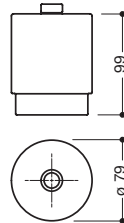

HEWI Glass container
for soap dispenser with holder 100.06.11045, 950.06.10045,
900Q03.002... and 900Q06.000...

· ø 79 mm, 99 mm high
· made of high-quality, satin-finished crystal glass

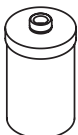

800.06.E01

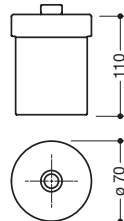

HEWI Glass container
for soap dispenser 800.06.11045 and 162.06.1105...

· ø 70 mm, 110 mm high
· made of high-quality, satin-finished crystal glass

Item Number

Dimensions in mm / Specification

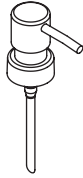

66988
66989

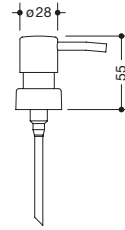

HEWI Pump head

· incl. riser tube, pump head stainless steel look

**for soap dispenser 900.06.000XA
for soap dispenser 900.06.001XA**

63910

HEWI Pump head

· incl. riser tube, pump head high-quality chrome-plated

63907

**for soap dispenser 815.06.11005, 815.06.11045, 815.06.11145,
815.06.11065, 815.06.11165, 815.06.11095 and 900.06.000..0
for soap dispenser 900.06.001..0**

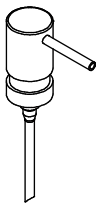

162.06.E01

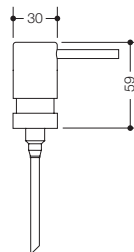

HEWI Pump head

for soap dispenser 162.06.110XA, 162.06.1105XA

· incl. riser tube

· pump head made of stainless steel, satin finished

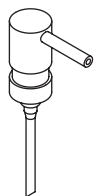

100.03.E02

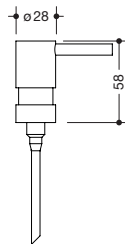

HEWI Pump head

**for soap dispenser 100.06.110..., 800.06.1104..., 800.06.010,
162.06.11...40, 950.06.10045, 900Q03.00240, 900Q06.00040**

· incl. riser tube

· pump head made of metal, high-quality chrome-plated

New 950.06.E02

**for soap dispenser 162.06.11165, 815.06.11265, 815.06.11365,
900.06.00160, 900Q03.00260, 900Q06.00060**

· when used in combination with soap dispensers 815.06.11065,
815.06.11165 and 900.06.00060, please order the glass container
800.06.E01 as well

· incl. riser tube

· pump head made of metal, black matt

New 950.06.E05

for soap dispenser 900.06.00160, 900Q03.00260, 900Q06.00060

· do., pump head made of metal, white matt

Item Number

Dimensions in mm / Specification



New 477.06.E04

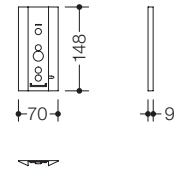

HEWI Wall-mounted base
for soap dispenser 477.06.1... and 800.06.10009...

- wall-mounted base to conceal drill holes
- made of high-quality polyamide in 16 HEWI colours

New 477.06BE04

for soap dispenser 477.06B1...

- do., made of high-quality matt polyamide in HEWI colours 99 (pure white), 98 (signal white), 97 (light grey), 95 (stone grey), 92 (anthracite grey), 90 (jet black), 74 (apple green) and 55 (aqua blue)

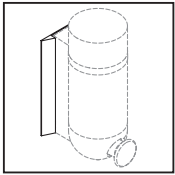

New 477.06DE04

for soap dispenser 477.06D10005

- do., made of polyamide in HEWI colour 98 (signal white), with active antimicrobial microsilver

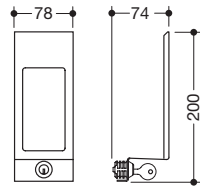

805.06.E01

HEWI Shutter
for disinfectant dispenser 805.06.350

- made of high-quality stainless steel, satin finished, with inspection window

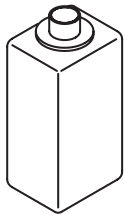

805.06.E02

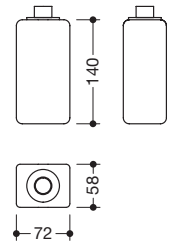

HEWI Empty container
for disinfectant dispenser 805.06.350

- made of synthetic material, capacity 500 ml

Item Number

Dimensions in mm / Specification

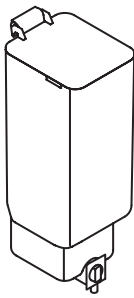

805.06.E03

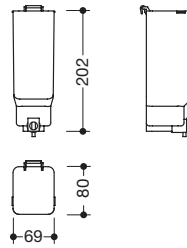

HEWI Empty container
for soap dispenser 805.06.100, 950.06.100 and 900.06.004...
 · incl. lotion pump
 · made of synthetic material, capacity 600 ml

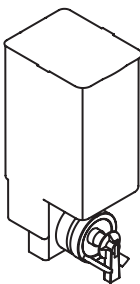

805.06.E04

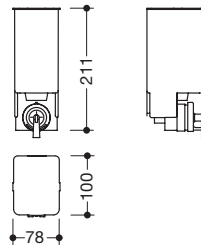

HEWI Empty container
for soap dispenser 805.06.150 and 950.06.150
 · incl. foam pump
 · made of synthetic material, capacity 1000 ml

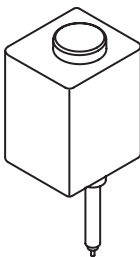

805.06.E05

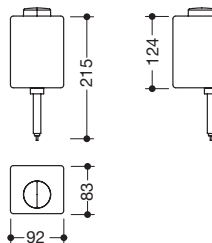

HEWI Empty container
for SENSORIC soap dispenser 805.06.115* and 950.06.115*
 · incl. lotion pump
 · made of synthetic material, capacity 1000 ml

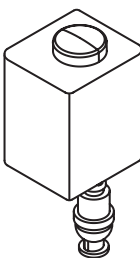

805.06.E06

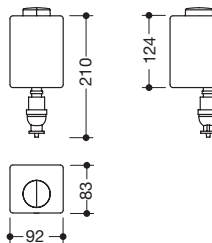

HEWI Empty container
for SENSORIC foam soap dispenser 805.06.155* and 950.06.155*
 · incl. foam pump
 · made of synthetic material, capacity 1000 ml

* for version up to 3/21

Item Number

Dimensions in mm / Specification

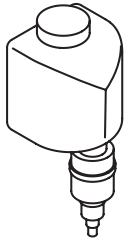

900.06.E02

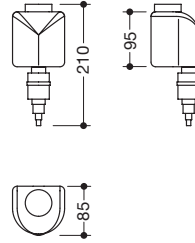

HEWI Soap tank and soap pump for SENSORIC soap dispenser 805, 900 and 950, 477/801**

- incl. soap pump
- made of synthetic material, capacity 500 ml

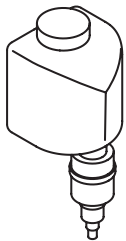

900.06.E03

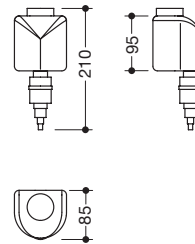

HEWI Disinfectant tank and spray pump for SENSORIC disinfectant dispenser 477/801, 805, 900 and 950**

- incl. spray pump
- made of synthetic material, capacity 500 ml

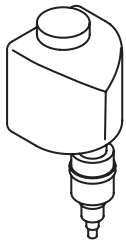

900.06.E04

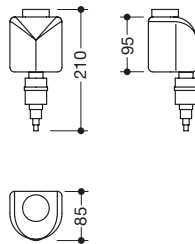

HEWI Soap tank and foam pump for SENSORIC foam soap dispenser 477/801, 805, 900 and 950**

- incl. foam pump
- made of synthetic material, capacity 500 ml

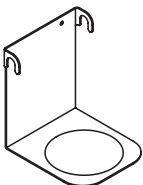

New 477.06.E0360

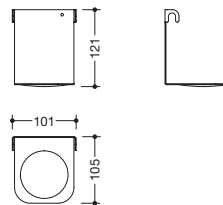

HEWI Drip tray for soap dispenser 477.06.101..., 477.06B101..., SENSORIC soap dispenser 477.06.102..., 477.06B102..., SENSORIC foam soap dispenser 477.06.103..., 477.06B103..., SENSORIC disinfectant dispenser 477.06.104..., 477.06B104...

- serves to collect dripping disinfectant and soap
- made of metal, powder-coated in HEWI colours DX (matt white) and FV (matt pure white)
- 101 mm wide, 121 mm high and 105 mm deep

** for version up to 3/21

Item Number

Dimensions in mm / Specification

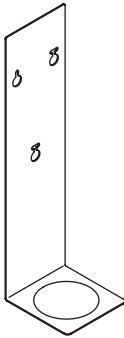

900.06.E0160

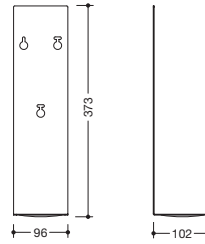

HEWI Drip tray
for disinfectant dispenser column 900.06.013...,
disinfectant dispenser 900.06.008..., soap dispenser 900.06.005...
and foam soap dispenser 900.06.007...

- serves to collect dripping disinfectant and soap
- 96 mm wide, 373 mm high and 102 mm deep
- fixed in place using the dispenser fixing points
- made of high-quality stainless steel, powder-coated in HEWI colours DX (matt white), AY (matt light grey pearl mica), SC (matt dark grey pearl mica) and DC (matt black)

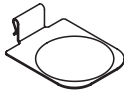

900.06.E0560

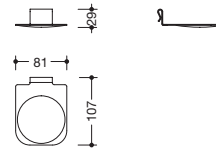

HEWI Drip tray
suitable for disinfectant or soap dispenser 900.06.00360,
900.06.00361 and 900.06.003XA

- serves to collect dripping disinfectant and soap
- 81 mm wide, 29 mm high and 107 mm deep
- to hang in the dispenser
- made of metal, powder-coated in HEWI colours DX (matt white), AY (matt light grey pearl mica), SC (matt dark grey pearl mica) and DC (matt black)



900.06.E0660

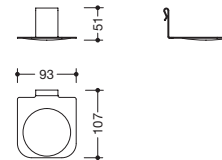

HEWI Drip tray
suitable for disinfectant or soap dispenser 900.06.002...,
disinfectant or soap dispenser column 900.06.012...

- serves to collect dripping disinfectant and soap
- 93 mm wide, 51 mm high and 107 mm deep
- to hang in the dispenser
- made of metal, powder-coated in HEWI colours DX (matt white), AY (matt light grey pearl mica), SC (matt dark grey pearl mica) and DC (matt black)

Item Number

Dimensions in mm / Specification

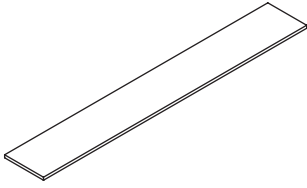

100.03.E01

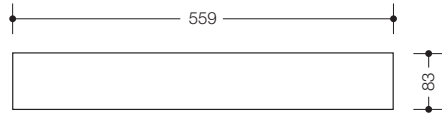

**HEWI Glass plate
for shelf 100.03.10045**

· made of high-quality, satin-finished glass

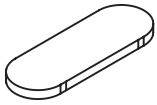

60169

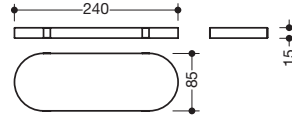

**HEWI Insert
for utility dishes 800.03.20041 and 800.03.2009...**

· made of high-quality polyamide in 16 HEWI colours

New 71819

for utility dish 800.03.20060

· made of high-quality matt polyamide in 98 (signal white) and 90 (jet black)

Please advise colour when ordering.

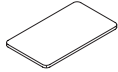

63499

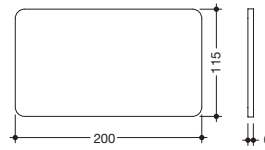

**HEWI Glass plate
for shelf 815.03.10005**

· 200 mm wide, 115 mm deep
· made of high-quality, satin-finished glass

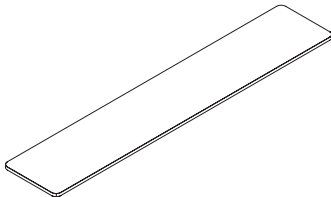

63484

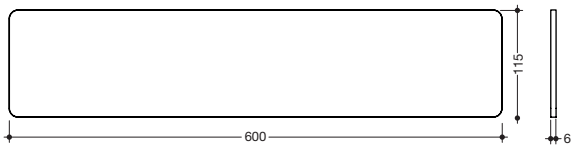

**HEWI Glass plate
for shelf 815.03.12005**

· 600 mm wide, 115 mm deep
· made of high-quality, satin-finished glass

Item Number

Dimensions in mm / Specification

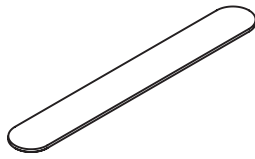
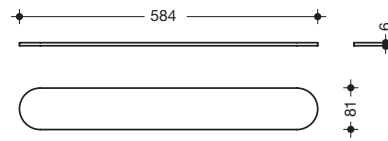
**58848**

**HEWI Glass plate
for shelf 800.03.10045**

- made of high-quality, satin-finished glass

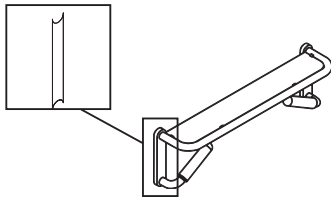
**802.03.WE02**

**HEWI Backplate cover, short White Edition
for shelf for mirror 802.03.W100, 802.03.W110L/R and
grab bar with backplate 802.03.W120L/R**

- two caps to cover the mounting points of the backplate
- in white powder coated metal

802.03.E02

**HEWI Backplate cover, short
for shelf for mirror 802.03.100, 802.03.110L/R and
grab bar with backplate 802.03.120L/R**

- do., in powder coated, matt silver metal

Item Number

Dimensions in mm / Specification

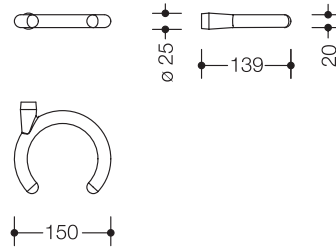
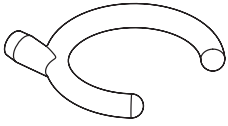

802.90.E01
802.90BE01

**HEWI Walking aid holder
for 950.90...60090**

- can be used in left hand or right hand position
- 150 mm wide, 20 mm high, 139 mm deep
- made of high-quality polyamide in 16 HEWI colours
- made of high-quality matt polyamide in 5 HEWI colours

Please advise colour when ordering.

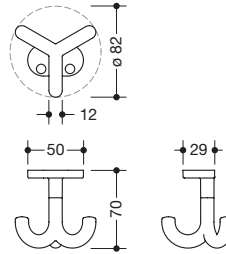

477.90.054

**HEWI Triple hook
for tumbler rack with hooks 800.03.402 and 800.03.412 and
shelf 800.03.404 and 800.03.414**

- for screwing on from underneath
- rotatable, 70 mm high, oval rose: 50 mm wide and 29 mm deep
- made of high-quality polyamide in 16 HEWI colours

New 477.90B054

**for tumbler rack with hooks 800.03B402 and 800.03B412 and
shelf 800.03B404 and 800.03.B414**

- do., made of high-quality matt polyamide in 16 HEWI colours

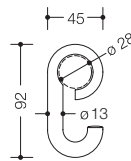

477.30.E01

HEWI Hook

- fits on to bath towel rails and grab bars \varnothing 28 mm
- can be moved anywhere on rail as required
- 92 mm high, 45 mm deep, \varnothing 13 mm
- made of high-quality polyamide in 16 HEWI colours

Item Number

Dimensions in mm / Specification

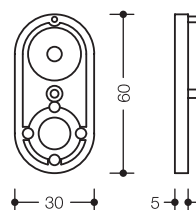

41939
68557

HEWI Extension piece

for mirror clip 477.01...100, 800.01.1009... and plate glass mirror with holders 801.01.300

- to compensate tile jumps, 5 mm thick
- more as needed extension pieces can be glued to each other
- made of high-quality polyamide in 16 HEWI colours
- made of high-quality matt polyamide in 5 HEWI colours

Please advise colour when ordering.

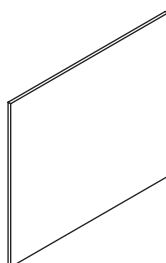

21755

HEWI Plate glass mirror with rigging for adjustable mirror 801.01...100 and 801.01.200

- 600 mm wide, 540 mm high and 6 mm thick
- with rounded edges and integrated splinter protection foil
- mirror is made of plate glass

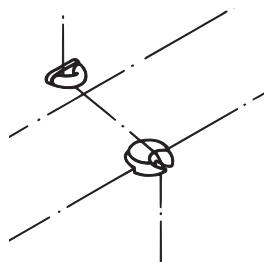

54436
68559

HEWI Cord re-routing

for adjustable mirror 801.01...100, 801.01...200 and 801.01...4...

- to guiding and deflecting the cord of the adjustable mirrors
- supplied with fixing material
- made of high-quality polyamide in 16 HEWI colours
- made of high-quality matt polyamide in 6 HEWI colours

Please advise colour when ordering.

62852

HEWI active+ Cord re-routing for adjustable mirror 801.01D100

- in HEWI colour 98 (signal white), with active antimicrobial microsilver



25244
68555

HEWI Rotating handle with cord

for adjustable mirror 801.01...100, 801.01...200 and 801.01...4...

- for adjusting inclination of the adjustable mirrors
- supplied with fixing material

- made of high-quality polyamide in 16 HEWI colours
- made of high-quality matt polyamide in 6 HEWI colours

Please advise colour when ordering.

62851

HEWI active+ Rotating handle with cord for adjustable mirror 801.01D100

- in HEWI colour 98 (signal white), with active antimicrobial microsilver

Item Number

Dimensions in mm / Specification

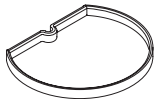

51876

**HEWI Ring insert
for waste bin 477.05.100 and 477.05.300**

- made of high-quality black polyamide
- for receiving the hygiene bag

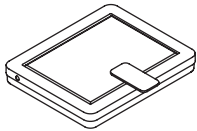
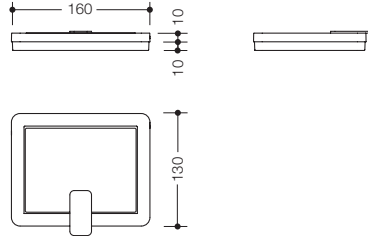

805.05.E03

**HEWI Lid with frame
for hygiene waste bin 805.05.200 and
hygiene combination 805.05.210**

- cover with lifting flap, made of high-quality stainless steel, satin finished
- frame made of high-quality polyamide in HEWI colours 90 (jet black), 92 (anthracite grey), 98 (signal white) or 99 (pure white)

Please advise colour when ordering.

950.05.E03

**HEWI Lid with frame
for hygiene waste bin 950.05.200 and
hygiene combination 950.05.210**

- cover with lifting flap, made of high-quality stainless steel, coated white
- frame made of high-quality, chrome-plated synthetic material

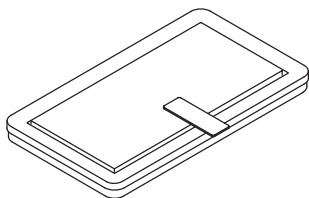
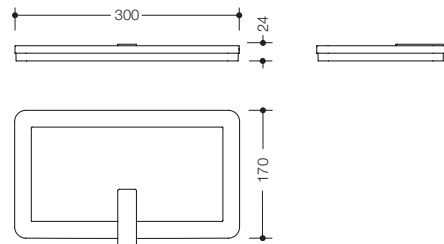

805.05.E01

**HEWI Lid with frame
for waste paper bin 805.05.100**

- cover with lifting flap, made of high-quality stainless steel, satin finished
- frame made of high-quality polyamide in HEWI colours 90 (jet black), 92 (anthracite grey), 98 (signal white) or 99 (pure white)

Please advise colour when ordering.

950.05.E01

**HEWI Lid with frame
for waste paper bin 950.05.100**

- cover with lifting flap, made of high-quality stainless steel, coated white
- frame made of high-quality, chrome-plated synthetic material

Item Number

Dimensions in mm / Specification

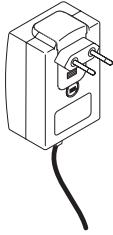

950.06.E01

HEWI Power supply
for electronic paper roll dispenser 900.06.010..., 805.06.55... and 950.06.55...

- 100–240 V, 50/60 Hz, 0,5 A
- 1x plug-type C (CEE 7/16 Euro plug) for Europe, except UK and Ireland
- protection class 2
- cable length approx. 1700 mm



477.06.E01

HEWI Key
for paper towel dispenser 477.06...60005, 805.06.500, 950.06.500 and 900.06.009...

- for locking the upper part

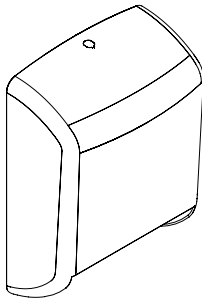

477.06.E02

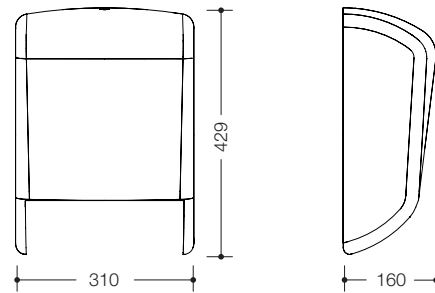

HEWI Container
for paper towel dispenser 477.06...60005

- 310 mm wide, 429 mm high, 160 mm deep
- made of high-quality white-translucent synthetic material

Item Number

Dimensions in mm / Specification

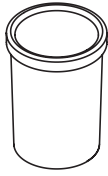

63500

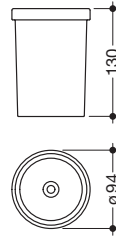

HEWI Brush container
for toilet brush unit 815.20.100... and 900Q20.000...
· 130 mm high
· made of high-quality, satin-finished glass

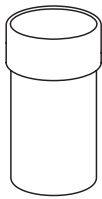

100.20.E01

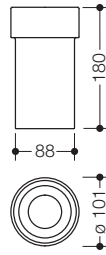

HEWI Glass for toilet brush
for toilet brush unit 100.20.10045
· container made of satin-finished crystal glass
· with inner reservoir



800.20.E01

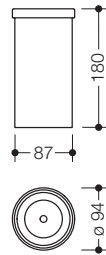

HEWI Glass for toilet brush
for toilet brush unit 800.20.10045
· made of high-quality, satin-finished crystal glass

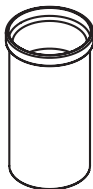

800.20.E02

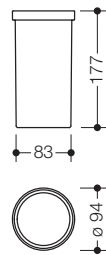

HEWI Brush container
for toilet brush unit 800.20.10041, 800.20.20041 and 800.20.2009...
· made of high-quality polyamide in 16 HEWI colours

for toilet brush unit 800.20.10260 and 800.20.20260
· made of high-quality matt polyamide in HEWI colours
(98) signal white and (90) jet black

New 71825

Please advise colour when ordering.

Item Number

Dimensions in mm / Specification

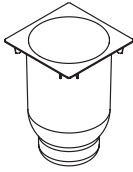

New 900Q20.E001

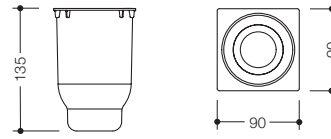

HEWI Insert
for toilet brush unit 900Q20.001...
 · 135 mm high
 · made of black matt synthetic material

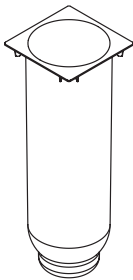

New 900Q20.E002

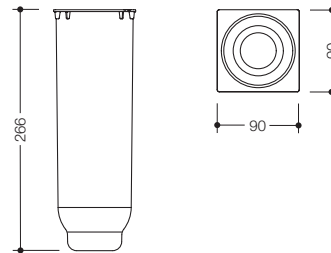

HEWI Insert
for toilet brush unit 900Q20.002...
 · 266 mm high
 · made of black matt synthetic material

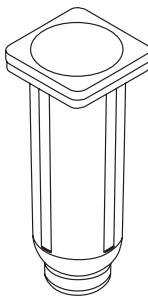

805.20.E02

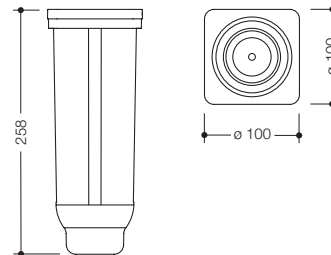

HEWI Insert
for toilet brush unit 805.20.200
 · made of high-quality polyamide in HEWI colours 90 (jet black),
 92 (anthracite grey) 98 (signal white) or 99 (pure white)
 Please advise colour when ordering.

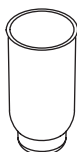

66823
 162.20.E01

HEWI Insert
 · made of synthetic material
for toilet brush unit 900.20.000...
for toilet brush unit 162.20.100...

Item Number

Dimensions in mm / Specification

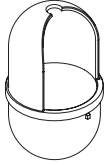

477.20.E04

**HEWI Toilet brush container
for toilet brush unit 477.20.100 and 805.20.100**

· made of high-quality polyamide in 16 HEWI colours

477.20.E05

for toilet brush unit 477.20.10005

· made of high-quality polyamide in HEWI colours 99 (pure white), 98 (signal white), 97 (light grey), 95 (stone grey), 92 (anthracite grey) and 90 (jet black)

· top made of translucent synthetic material in colour white

477.20BE04

for toilet brush unit 477.20B100

· made of high-quality matt polyamide in 5 HEWI colours

Please advise colour when ordering.

62850

**HEWI active[®] Toilet brush container
for toilet brush unit 477.20D100**

· in HEWI colour 98 (signal white), with active antimicrobial microsilver

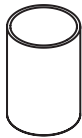

950.20.E01

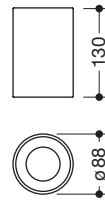

HEWI Glass for toilet brush

for toilet butler 950.20.50045 and toilet brush unit 950.20.10045

· made of high-quality satin-finished crystal glass

· ø 88 mm, 130 mm high

Item Number

Dimensions in mm / Specification



477.20.E03
68562

HEWI Brush handle
for toilet brush unit 477.20... and toilet brush 477.20...010

- suitable for brush head 921037, 921038 and 921044
- with bayonet fixing
- made of high-quality polyamide in 16 HEWI colours
- made of high-quality matt polyamide in 5 HEWI colours

Please advise colour when ordering.



921037
921044
921038

HEWI brush head
for toilet brush unit 477.20..., 801.20..., 802.20.100 and 805.20.100
for toilet brush 477.20..., 801.20..., 802.20.010 and 805.20.010

- for easy replacement on toilet brush by bayonet fixing
- with black bristles
- ø 81 mm

packing unit 1 pc
packing unit 5 pcs
packing unit 25 pcs

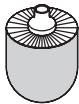

921050
921051
921052

HEWI brush head
for toilet brush unit 805.20.200, 162.20.100..., 100.20.100..., 800.20.100..., 800.20.200..., 815.20..., 900.20..., 900Q20...
for toilet brush 805.20.020, 100.20.010..., 800.20.010... and 59405

- for easy replacement on toilet brush by bayonet fixing
- brush head made of black polyamide with bristles in anthracite grey
- ø 76 mm

packing unit 1 pc
packing unit 5 pcs
packing unit 25 pcs



42527

HEWI Key
for toilet roll holder 477.21...150

- for anti-theft protection-unlocking in colour 33 (ruby red)
- made of high-quality polyamide



18565
68554

HEWI Retaining element
for toilet roll holder 477.21...150

- anti-theft protection due to concealed fitting
- made of high-quality polyamide in 16 HEWI colours
- made of high-quality matt polyamide in 5 HEWI colours

Please advise colour when ordering.

Item Number

Dimensions in mm / Specification



4471
68558

**HEWI End cap
for toilet roll holder 477.21...100**

- cap to cover the bow
- \varnothing 20 mm
- made of high-quality polyamide in 16 HEWI colours
- made of high-quality matt polyamide in 5 HEWI colours

Please advise colour when ordering.

62718

**HEWI active⁺ End cap
for toilet roll holder 477.21D100**

- in HEWI colour 98 (signal white), with active antimicrobial microsilver

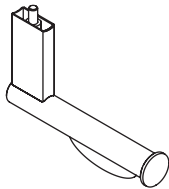

68424
68425
68426
67975
67976

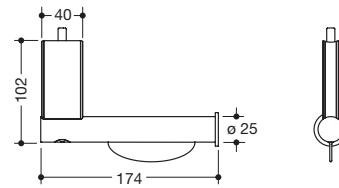

**HEWI Upgrade kit toilet roll holder
for retrofitting on HEWI rail system System 900**

- right angled add-on toilet roll holder
- easy installation, integrated roll brake
- 39 mm wide, 102 mm high, 174 mm deep
- for \varnothing 32 mm, made of high-quality stainless steel, satin finished
- for \varnothing 30 mm, made of high-quality stainless steel, chrome-plated
- for \varnothing 32 mm, made of high-quality stainless steel, chrome-plated
- for \varnothing 32 mm, made of high-quality stainless steel, powder-coated
- for \varnothing 30 mm, made of high-quality stainless steel, powder-coated

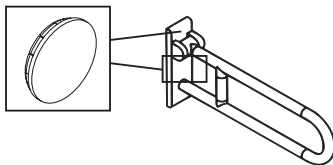

39006
68556

**HEWI Masking cap
for hinged support rail 801.50... and hinged seat 801.51...**

- two caps to cover the fixing points
- \varnothing 23 mm
- delivery in pairs

- made of high-quality polyamide in 16 HEWI colours
- made of high-quality matt polyamide in 5 HEWI colours

Please advise colour when ordering.

62853

**HEWI active⁺ Masking cap
for hinged support rail 801.50D.. and hinged seat 801.51D..**

- in HEWI colour 98 (signal white), with active antimicrobial microsilver

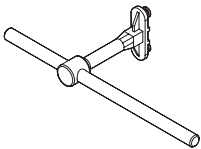

802.50.E04

**HEWI Installation key
for hinged support rails 802.50...**

- to the spring setting on the hinged support rail
- consists of mounting handle and axle

Item Number

Dimensions in mm / Specification

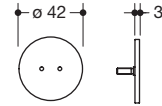

**HEWI Masking cap
for axle of hinged support rails System 900, Design A**

- \varnothing 42 mm
- made of high-quality stainless steel
- satin finished
- chrome-plated
- powder-coated

66865
66867
67724

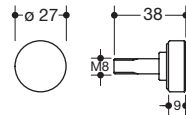

**HEWI Locking screw
for mobile hinged support rails System 900, Design A**

- made of high-quality stainless steel
- satin finished
- chrome-plated
- powder-coated

67364
67367
67978

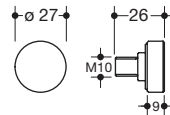

**HEWI Locking screw
for hinged support rails System 900, Design A**

- made of high-quality stainless steel
- satin finished
- chrome-plated
- powder-coated

67365
67368
67979

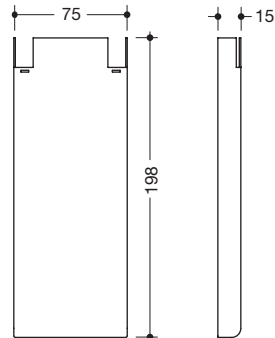
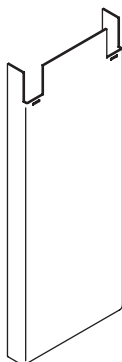

**HEWI Cover
for hinged support rails System 900, Design B**

- lower cover of the wall plate
- made of high-quality stainless steel
- satin finished
- chrome-plated
- powder-coated

67369
67370
68001

Item Number

Dimensions in mm / Specification

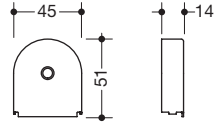

HEWI Joint cap
for hinged support rails System 900, Design B

- made of high-quality stainless steel
- satin finished
- chrome-plated
- powder-coated

67371
67372
68002

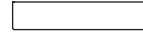
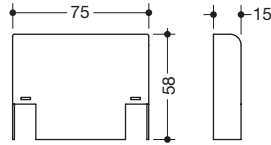
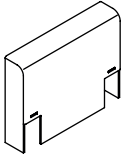

HEWI Cover
for hinged support rails System 900, Design B

- upper cover of the wall plate
- made of high-quality stainless steel
- satin finished
- chrome-plated
- powder-coated

67373
67374
68008

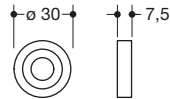

HEWI Stop element
for hinged support rails Duo System 900, Design B

- made of high-quality stainless steel

67378

Item Number

Dimensions in mm / Specification

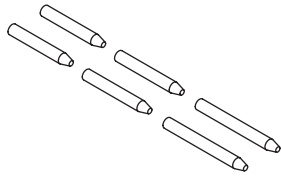
**New** BM1151**HEWI Set of dowel pins
for backrest 801.51.9..., 801.51.92...L/R, 801.51B9... and
801.51B92...L/R**

- for attaching the backrest to the hinged support rail
- included: 2x cylindrical pin \varnothing 4x28, 2x cylindrical pin \varnothing 4x30 and 2x cylindrical pin \varnothing 4x37
- made of stainless steel

Item Number

Dimensions in mm / Specification

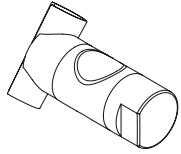

70899

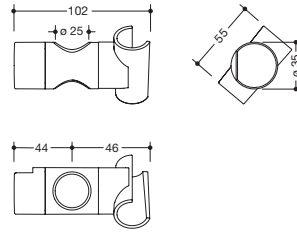

HEWI Shower head holder

for rails with shower head holder System 900 ø 25 mm

- suitable for various manufacturers' shower heads
- shower head holder can be tilted continuously and, after pressing a pushbutton, its height can be adjusted
- made of synthetic material, chrome-plated

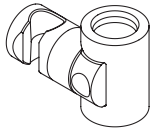

66771

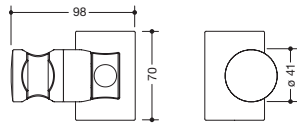

HEWI Shower head holder

for rails with shower head holder System 900 ø 32 mm

- suitable for various manufacturers' shower heads
- shower head holder can be tilted continuously and, after pressing a large pushbutton, its height can be adjusted
- conical adapter on shower head holder facilitates accommodation of handspray
- made of high-quality matt polyamide in HEWI colours 98 (signal white), 92 (anthracite grey) and 90 (jet black)

Please advise colour when ordering.

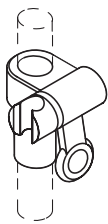

950.33.E0191

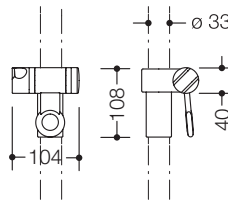

HEWI Shower head holder

- with conical holding element (left) for shower head
- suitable for various manufacturers' shower heads
- shower head holder adjustable to desired height (via lever control) and angle (smooth adjusting)
- conical holding element facilitates accommodation of handspray
- 108 mm high, 93 mm wide

for rail with shower head holder, L-shaped support rail with shower head holder and shower grab rail 950...91, 950...51

- made of high-quality polyamide in HEWI colour 98 (signal white)
- grip zone of the shower head holder in HEWI colours 98 (signal white), 92 (anthracite grey) and 33 (ruby red)

950.33.E0199

for rail with shower head holder, L-shaped support rail with shower head holder and shower grab rail 950...99

- made of high-quality polyamide in HEWI colour 99 (pure white)
- grip zone of the shower head holder in HEWI colours 99 (pure white), 92 (anthracite grey) and 33 (ruby red)

950.33.E0194

for rail with shower head holder, L-shaped support rail with shower head holder and shower grab rail 950...54

- made of high-quality polyamide in HEWI colour 92 (anthracite grey)

Item Number

Dimensions in mm / Specification

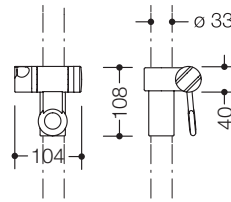
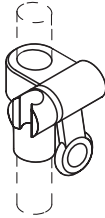

950.33.E0190
950.33BE0190

HEWI Shower head holder

for rail with shower head holder, L-shaped support rail with shower head holder and shower grab rail 477..., 801..., 950...90

- with conical holding element (left) for shower hose and shower head
- suitable for various manufacturers' shower heads
- shower head holder adjustable to desired height (via lever control) and angle (smooth adjusting)
- conical holding element facilitates accommodation of handspray
- 108 mm high, 93 mm wide
- with contrasting (white or black) marked shower head holder

- made of high-quality polyamide in 16 HEWI colours
- made of high-quality matt polyamide in 5 HEWI colours

Please advise colour when ordering.

950.33DE0190

HEWI active* Shower head holder for rails with shower head holder 477.33D1..., 801.33D... and shower grab rails 801.35D...

- in HEWI colour 98 (signal white), with active antimicrobial microsilver

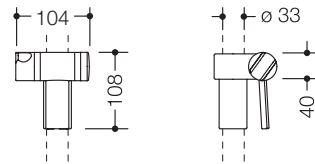
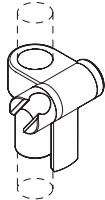

805.33.E01

HEWI Shower head holder

for rails with shower head holder 805.33... and shower grab rails 805.35...

- with conical holding element (left) for shower hose and shower head
- shower head holder adjustable to desired height (via lever control) and angle (smooth adjusting)
- 108 mm high, 93 mm wide
- made of high-quality polyamide in HEWI colours 90 (jet black), 92 (anthracite grey), 98 (signal white) or 99 (pure white)

Please advise colour when ordering.

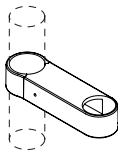

61979
68563

HEWI Shower hose holder

- for retrofitting on HEWI shower holder rods and shower and bath handrails Range 477 and 801

- is used to hold the shower hose to the shower head holder
- 131 mm lang, 38 mm wide, 25 mm high
- suitable for shower hose diameters up to 29 mm

- made of high-quality polyamide in 16 HEWI colours
- made of high-quality matt polyamide in 5 HEWI colours

Please advise colour when ordering.

Item Number

Dimensions in mm / Specification



921056
New 921060

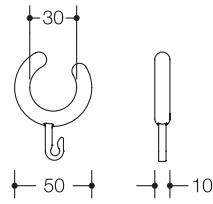

**HEWI Curtain rings
 for shower curtain rails 900.34...**

- open ring with small hook
- for hanging curtains to curtain rails \varnothing 24 mm
- outside \varnothing 50 mm, inside \varnothing 30 mm, 10 mm thick

- made of high-quality white POM
- made of high-quality black POM

Packing unit 5 pcs

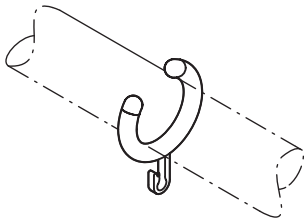

801.34.E01
68560

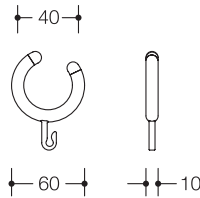

**HEWI Curtain rings
 for shower curtain rails 801.34...**

- open ring with small hook
- outside \varnothing 60 mm, inside \varnothing 40 mm, 10 mm thick
- ring ends made of white POM

- made of high-quality polyamide in 16 HEWI colours
- made of high-quality matt polyamide in 5 HEWI colours

Packing unit 5 pcs

Please advise colour when ordering.

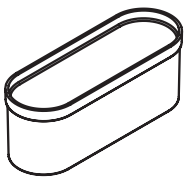

60170

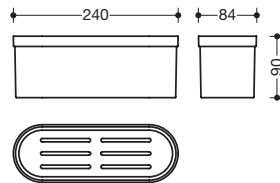

**HEWI Insert
 for shower basket 800.03.30041, 800.03.3009... and
 shelf with hole 950.13.00...**

- made of high-quality polyamide in 16 HEWI colours

Please advise colour when ordering.

Item Number

Dimensions in mm / Specification



66758
66759
67971

**HEWI Rose cap
for rails System 900 with \varnothing 25, 30 and 32 mm**

- \varnothing 67 mm
- made of stainless steel
- satin finished
- chrome-plated
- powder-coated



66760
66761
67970

**HEWI Rose cap
for shower curtain rails and ceiling supports System 900**

- \varnothing 67 mm
- made of stainless steel
- satin finished
- chrome-plated
- powder-coated



66762
66763
67972

**HEWI Rose cap with hole
for rails System 900 with \varnothing 30 mm**

- rose fixing on corner support, with hole
- \varnothing 67 mm
- made of stainless steel
- satin finished
- chrome-plated
- powder-coated



66764
66765
67973

**HEWI Rose cap with hole
for rails System 900 with \varnothing 32 mm**

- rose fixing on corner support, with hole
- \varnothing 67 mm
- made of stainless steel
- satin finished
- chrome-plated
- powder-coated



66766
66778
67974

**HEWI Rose cap with hole
for rails System 900 with \varnothing 32 mm**

- rose fixing on middle support, with hole
- \varnothing 67 mm
- made of stainless steel
- satin finished
- chrome-plated
- powder-coated



66779
71176
71177



**HEWI Tight round plate with bolt circle
for rail systems 900, 801 (steel core) and
805 Classic with bolt circle rose \varnothing 70 mm**

- for additional sealing of the drilling points at tile spacers and tile offset
- packing unit 10 pcs
- packing unit 50 pcs
- packing unit 100 pcs



71178
71179
71180

for rail system 801 (aluminum core and roses of synthetic mat.)

- do.
- packing unit 10 pcs
- packing unit 50 pcs
- packing unit 100 pcs

Item Number

Dimensions in mm / Specification



815.90.E0140

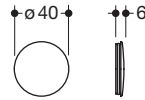

HEWI Rose cap

for all roses of articles 815.21.10040, 815.21.20040, 815.20.10045, 815.21.30040, 815.21.31040, 815.90.01040, 815.90.02040, 815.09.11040, 815.09.30040, 815.06.11045, 815.04.11045, 815.03.12045, 815.30.11040

· stainless steel, chrome-plated

815.90.E0160

for all roses of articles 815.21.10060, 815.21.20060, 815.20.10065, 815.21.30060, 815.21.31060, 815.90.01060, 815.90.02060, 815.09.11060, 815.09.30060, 815.06.11065, 815.04.11065, 815.03.12065, 815.30.11060

· stainless steel, black matt powder-coated



63510

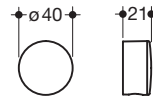

HEWI Rose

for tumbler with holder 815.04.11005, soap dispenser with holder 815.06.11005, toilet brush unit 815.20.10005, hook 815.90.010 and double hook 815.90.020

· high-quality chrome-plated

63511

for tumbler with holder 815.04.11090/...95, soap dispenser with holder 815.06.11090/...95, toilet brush unit 815.20.10090/...95, hook 815.90.01090 and double hook 815.90.02090

· high-quality synthetic material in 16 HEWI colours

63512

for bath towel rail 815.30.110, 815.30.120 and spare roll holder 815.21.300

· high-quality chrome-plated

63513

for bath towel rail 815.30.11090, 815.30.12090 and spare roll holder 815.21.30090

· high-quality synthetic material in 16 HEWI colours



63514

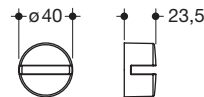

HEWI Rose

for shelf 815.03.10005, 815.03.11005 and 815.03.12005

· high-quality chrome-plated

63515

for shelf 815.03.10095, 815.03.11095 and 815.03.12095

· high-quality synthetic material in 16 HEWI colours



63516

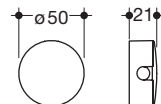

HEWI Rose

for towel holder 815.09.100 and 815.09.110

· high-quality chrome-plated

63517

for towel holder 815.09.10090 and 815.09.11090

· high-quality synthetic material in 16 HEWI colours

Item Number

Dimensions in mm / Specification



63518

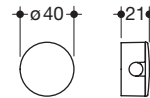

HEWI Rose
for toilet roll holder 815.21.100, toilet roll holder
with lid 815.21.200, spare roll holder double 815.21.310 and
towel ring 815.09.300

- high-quality chrome-plated

63519

**for toilet roll holder 815.21.10090, toilet roll holder
with lid 815.21.20090, spare roll holder double 815.21.31090 and
towel ring 815.09.30090**

- high-quality synthetic material in 16 HEWI colours



805.35.E01

HEWI Rose cap
for railing system \varnothing 33 mm, stainless steel

- for rose fixing on bend

- \varnothing 70 mm

- made of high-quality stainless steel, surface satin finished



805.35.E02

HEWI Rose cap
for railing system \varnothing 33 mm, stainless steel

- for rose fixing on support with hole

- \varnothing 70 mm

- made of high-quality stainless steel, surface satin finished

10856
68524

HEWI Rose cap
for railing system \varnothing 33 mm

- for rose fixing on bend

- \varnothing 70 mm

- made of high-quality polyamide in 16 HEWI colours

- made of high-quality matt polyamide in 5 HEWI colours

Please advise colour when ordering.

62800

HEWI active+ Rose cap
for railing system \varnothing 33 mm

- in HEWI colour 98 (signal white), with active antimicrobial microsilver

10862
68552

HEWI Rose cap, divided
for railing system \varnothing 33 mm

- for rose fixing on support

- \varnothing 70 mm

- made of high-quality polyamide in 16 HEWI colours

- made of high-quality matt polyamide in 5 HEWI colours

Please advise colour when ordering.

62737

HEWI active+ Rose cap, divided
for railing system \varnothing 33 mm

- in HEWI colour 98 (signal white), with active antimicrobial microsilver



921057

HEWI Cap
for rose cap 805.35.E02, stainless steel

- for concealing hole

- \varnothing 8 mm

- made of high-quality stainless steel, surface satin finished

- packing unit 3 pcs

Item Number

Dimensions in mm / Specification



65747

HEWI Eccentric washer

- for mobile hinged seats System 900 and 950
- packing unit 2 pcs



65966

HEWI Eccentric washer

- for hinged seats System 900 and 950
- packing unit 2 pcs

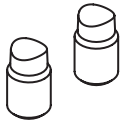

66644

HEWI Brake unit

- for hinged and removable hanging seats System 900



66863
67734

HEWI Locking screw

- for mobile hinged seats System 900
- made of high-quality stainless steel
- satin finished
- powder-coated



66864
66866
67723

HEWI Cap

- for axle of hinged seats System 900
- ø 42 mm
- made of high-quality stainless steel
- satin finished
- chrome-plated
- powder-coated



66865
66867
67724

HEWI Cap

- for axle of hinged seats System 900
- ø 42 mm
- made of high-quality stainless steel
- satin finished
- chrome-plated
- powder-coated



67723

HEWI Cap

- for axle of removable hanging seats System 900
- ø 42 mm
- made of high-quality stainless steel, powder-coated

Item Number

Dimensions in mm / Specification



67724

HEWI Cap

- for axle of removable hanging seats System 900
- ø 42 mm
- made of high-quality stainless steel, powder-coated



68252

**HEWI Locking screw
for mounting plate 950.51.014 of the mobile seats 950**

- made of high-quality stainless steel

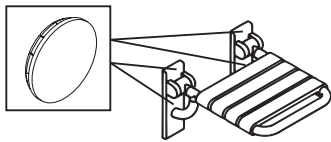

39006

68556

62853

**HEWI Masking cap
for hinged support rail 801.50... and hinged seat 801.51...**

- two caps to cover the fixing points
- ø 23 mm
- delivery in pairs

- made of high-quality polyamide in 16 HEWI colours
- made of high-quality matt polyamide in 5 HEWI colours

Please advise colour when ordering.

**HEWI active* Masking cap
for hinged support rail 801.50D.. and hinged seat 801.51D..**

- in HEWI colour 98 (signal white), with active antimicrobial microsilver

Spare parts | S 50 Height-adjustable modules

Item Number

Dimensions in mm / Specification

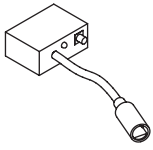

S50.02.02001

HEWI Radio receiver

- for linking the HEWI WC (radio) flushing mechanism add-on kits for hinged support rails to the S 50 height-adjustable toilet modules
- can only be used in combination with the height-adjustable toilet prewall elements with sensor-controlled flushing mechanism S50.02.02000, S50.02.02100 or S50.02.02200

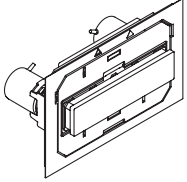

66246

HEWI Flushing plate, manual

- for height-adjustable toilet module with manual flushing mechanism S50.02.102010
- front white

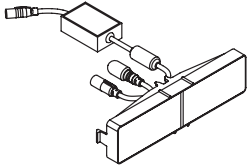

66638

HEWI Electronic unit

- for OLI 120 Plus cistern of the height-adjustable toilet modules with sensor-controlled flushing mechanism S50.02.02000, S50.02.02100 and S50.02200

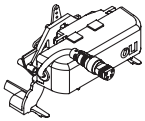

66640

HEWI Servomotor

- for OLI 120 Plus cistern of the height-adjustable toilet modules with sensor-controlled flushing mechanism S50.02.02000, S50.02.02100 and S50.02200

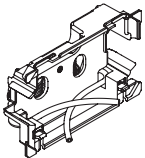

66260

HEWI Lever block for cistern

- for OLI 120 Plus cistern of the height-adjustable toilet modules with manual flushing mechanism S50.02.01000, S50.02.01100 or S50.02.01200

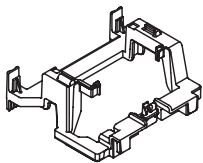

66262

HEWI Lever block for cistern

- for OLI 120 Plus cistern of the height-adjustable toilet modules with sensor-controlled flushing mechanism S50.02.02000, S50.02.02100 or S50.02.02200

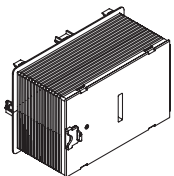

66269

HEWI Protective box

- for height-adjustable toilet prewall elements S50.02...

Item Number

Dimensions in mm / Specification

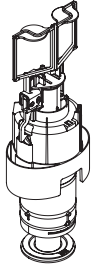

66256

HEWI Outlet valve for cistern

· for OLI 120 Plus cistern of the height-adjustable toilet modules with manual flushing mechanism S50.02.01000, S50.02.01100 or S50.02.01200

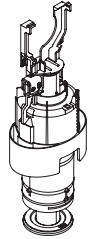

66258

HEWI Outlet valve for cistern

· for OLI 120 Plus cistern of the height-adjustable toilet modules with sensor-controlled flushing mechanism S50.02.02000, S50.02.02100 or S50.02.02200

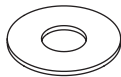

66268

HEWI Sealing rings for cistern

· for OLI 120 Plus cistern of the height-adjustable toilet modules S50.02...
· packing unit 10 pcs

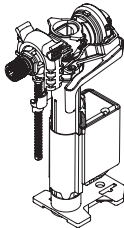

66264

HEWI Inlet valve for cistern

· for OLI 120 Plus cistern of the height-adjustable toilet modules S50.02...

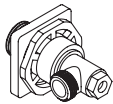

66266

HEWI Shut-off valve for cistern

· for OLI 120 Plus cistern of the height-adjustable toilet modules S50.02...

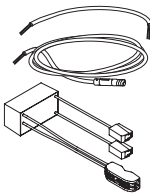

67672

HEWI Power supply unit

· for supplying power for the OLI120 Plus dual flush cistern
· for prewall elements of the S 50 toilet modules with sensor-controlled flushing mechanism S50.02.02...

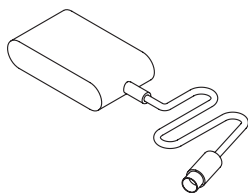

65057

HEWI Remote control receiver

· receiver of the remote control for adjusting the height of modules S 50

Item Number

Dimensions in mm / Specification

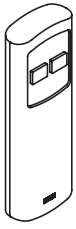

65056

HEWI Remote control

- for adjusting the height of modules S 50

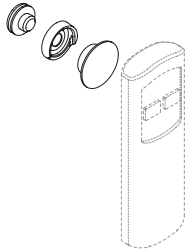

New S50.01.00001

HEWI Fidlock fixing S 50 for remote control

- magnetic latch lock with adhesive fixing incl. anti-theft device, in black
- for fixing the remote control onto the wall, onto the module or onto the washbasin

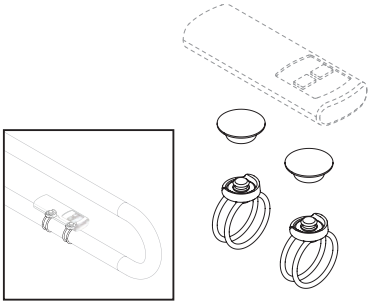

New S50.02.00001

HEWI Fidlock fixing S 50 for remote control

- magnetic latch locks with anti-theft device
- to protect the S 50 remote control from theft
- for attaching the remote control to HEWI hinged support rails of systems 801, 805, 900 and 950



70929

HEWI WC flushing mechanism symbol S 50

- consisting of pictograms made from special grey PVC film
- resistant to standard commercial cleaning agents
- for attaching to acrylic glass surfaces
- in dark grey

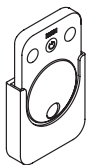

65058

HEWI Remote control LED mirror

- for controlling the light of the LED illuminated mirror of the height-adjustable washbasin modules S50.01.2...

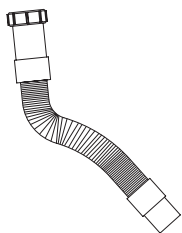

65059

HEWI Flex hose

- synthetic material-Flex hose McAlpine FYNE 240 x 40 comp
- for height-adjustable washbasin modules S50.01...

Item Number

Dimensions in mm / Specification



111705

**HEWI Laminar tap flow regulator
for washbasin fittings AQ 950, AQ 800, AQ 800 K**

- for single lever washbasin mixer tap AQ1.12M101..., AQ1.12M102... and AQ1.12M103...
- for electronic washbasin fittings AQ1.12S200..., AQ1.12S201..., AQ1.12S210... and AQ1.12S211...
- with dynamic flow control to 5 l/min



111706

**HEWI Laminar tap flow regulator
for washbasin fittings AQ 477/801, AQ 162**

- for single lever washbasin mixer tap AQ1.12M10440, AQ1.12M10540
- for electronic washbasin fittings AQ1.12S22040, AQ1.12S22140, AQ1.12S23040 and AQ1.12S23140
- with dynamic flow control to 5 l/min



111727

**HEWI Tap flow regulator with aeration
for single lever washbasin mixer tap AQ 100**

- for AQ1.12M10040



111731

**HEWI Flow rate controller
for shower thermostats**

- for AQ1.32T10040, AQ1.32T500... and AQ1.32T10140

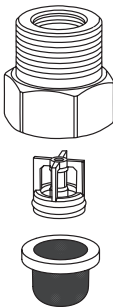

70247

**HEWI Backflow preventer with dirt filter
for electronic washbasin fittings**

111733

**HEWI Backflow preventer with integrated flow rate controller
for single lever shower mixer taps**

111734

**HEWI Backflow preventer without integrated flow rate controller
for shower thermostats and single lever bath mixer taps**

Item Number

Dimensions in mm / Specification



65699
71427

**HEWI Operating lever
for single lever washbasin mixer tap AQ 950**

- with hot-cold marking
- for AQ1.12M10340, high-quality chrome-plated
- for AQ1.12M10360, black powder-coated



68287
71428
70065

**HEWI Operating lever
for single lever washbasin mixer tap AQ 950**

- with hot-cold marking
- for AQ1.12M10940, high-quality chrome-plated
- for AQ1.12M10960, black powder-coated
- for AQ1.12M109XA, PVD coated stainless steel look

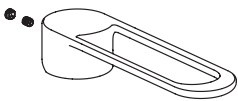

65697
71424

**HEWI Operating lever
for single lever washbasin mixer tap AQ 800**

- with hot-cold marking
- for AQ1.12M10140, high-quality chrome-plated
- for AQ1.12M10160, black powder-coated

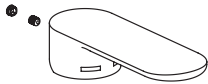

68286
71425

**HEWI Operating lever
for single lever washbasin mixer tap AQ 800**

- with hot-cold marking
- for AQ1.12M10840, high-quality chrome-plated
- for AQ1.12M10860, black powder-coated

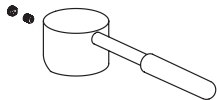

65698
65723
68288
71423

**HEWI Operating lever
for single lever washbasin mixer tap AQ 800 K**

- with coloured gripping element made of polyamide
- with hot-cold marking
- high-quality chrome-plated
- for AQ1.12M10240
- for AQ1D12M10240
- for AQ1B12M10240
- black powder-coated
- for AQ1.12M10260

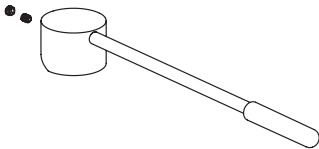

New 72019
New 72021
New 72020

New 72022

**HEWI Operating lever
for single lever washbasin mixer tap AQ 800 K**

- with long, coloured gripping element made of polyamide
- with hot-cold marking
- high-quality chrome-plated
- for AQ1.12M11040
- for AQ1B12M11040
- for AQ1D12M11040
- black powder-coated
- for AQ1.12M11060, AQ1B12M11060

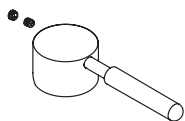

65718
65724

**HEWI Operating lever
for single lever washbasin mixer tap AQ 477/801**

- high-quality chrome-plated, with coloured gripping element made of polyamide
- with hot-cold marking
- for AQ1.12M10640
- for AQ1D12M10640

Item Number

Dimensions in mm / Specification

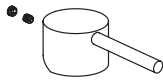

65700

HEWI Operating lever
for single lever washbasin mixer tap AQ 477/801, AQ 162
 · for AQ1.12M10440, AQ1.12M10540
 · high-quality chrome-plated
 · with hot-cold marking

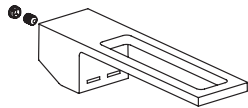

65696

HEWI Operating lever
for single lever washbasin mixer tap AQ 100
 · for AQ1.12M10040
 · high-quality chrome-plated
 · with hot-cold marking

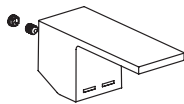

68285

HEWI Operating lever
for single lever washbasin mixer tap AQ 100
 · for AQ1.12M10740
 · high-quality chrome-plated
 · with hot-cold marking

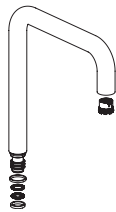

65687

HEWI Outlet
for single lever washbasin mixer tap AQ 477/801
 · for AQ1.12M10440

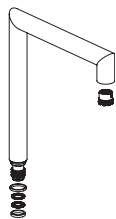

65689

HEWI Outlet
for single lever washbasin mixer tap AQ 162
 · for AQ1.12M10540

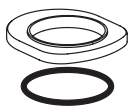

66601
 71429

HEWI Base
for single lever washbasin mixer tap AQ 950
 · for AQ1.12M10340 and AQ1.12M10940
 · for AQ1.12M10360 and AQ1.12M10960



65701
 71426

HEWI Base
for single lever washbasin mixer tap AQ 800, AQ 800 K, AQ 477/801, AQ 162
 · for AQ1.12M10140, AQ1.12M10240, AQ1.12M10440, AQ1.12M10540
 · for AQ1.12M10160, AQ1.12M10260, AQ1.12M10860, AQ1B12M10260

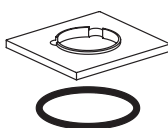

65702

HEWI Base
for single lever washbasin mixer tap AQ 100
 · for AQ1.12M10040

Item Number

Dimensions in mm / Specification

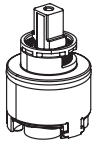

111702

HEWI Ceramic cartridge Kerox K-35OP
for single lever washbasin mixer tap AQ 950, AQ 800, AQ 800 K
 · for AQ1.12M101..., AQ1.12M102... and AQ1.12M103...

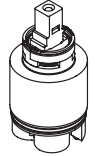

111703

HEWI Ceramic cartridge Kerox K-35B
for single lever washbasin mixer tap AQ 477/801, AQ 162
 · for AQ1.12M10440, AQ1.12M10540

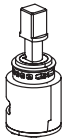

111704

HEWI Ceramic cartridge Kerox K-25OP-S
for single lever washbasin mixer tap AQ 100
 · for AQ1.12M10040

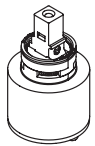

111732

HEWI Ceramic cartridge Kerox K-35A
for single-lever shower and bath mixer taps



65703

HEWI Electronic cartridge with sensor module
for electronic washbasin fittings



65677

HEWI Sensor module
for electronic washbasin fittings
 · for AQ1.12S...



65713

HEWI Bluetooth-Adapter
for electronic washbasin fittings
 · use only recommended for fittings with mains operation

Item Number

Dimensions in mm / Specification

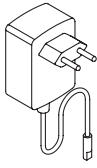

111707

**HEWI Power supply
for electronic washbasin fittings**

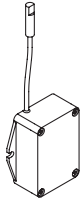

111708

**HEWI Battery compartment CR-P2 6V
for electronic washbasin fittings**

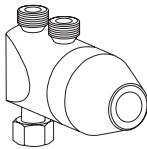

65087

HEWI Mini thermostat

- for limiting and monitoring the maximum discharge temperature, for mechanical or electronic washbasin fittings
- anti-scald protection is ensured using an expandable material thermostatic cartridge to EN 1111
- noise class 1
- one inlet 3/8" union nut (UN), two outputs 3/8" connecting thread (CT), one connection hose for cold water and one Y-piece included in delivery

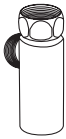

65754

**HEWI Shower hose drain valve
for shower thermostats, single-lever shower mixer taps,
single-lever bath mixer taps**

- for AQ1.32...

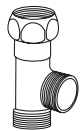

65755

**HEWI Tee fitting for cold water connection
for electronic washbasin fittings**

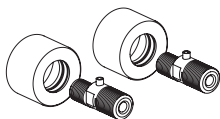

65757
71453

**HEWI S-connection set, lockable, round
for shower thermostats, single-lever shower mixer taps,
single-lever bath mixer taps**

- with push roses made of brass
- chrome-plated
- black powder-coated (for AQ1.32T50060)

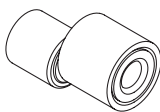

111752

**HEWI S-connection with silencer
for shower thermostats, single-lever shower mixer taps,
single-lever bath mixer taps**

- for AQ1.32...

Item Number

Dimensions in mm / Specification

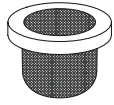

171061

HEWI Grit strainer
for electronic washbasin fittings



111741

HEWI Grit strainer
for shower thermostats, single-lever shower mixer taps,
single-lever bath mixer taps

- for AQ1.32...
- with fibreglass gasket



111696

HEWI Tap flow regulator dismantling key
for washbasin fittings **AQ 950, AQ 800, AQ 800 K**

- for single lever washbasin mixer tap AQ1.12M101..., AQ1.12M102... and AQ1.12M103...
- for electronic washbasin fittings AQ1.12S200..., AQ1.12S201..., AQ1.12S210... and AQ1.12S211...



111697

HEWI Tap flow regulator dismantling key
for washbasin fittings **AQ 477/801, AQ 162**

- for single lever washbasin mixer tap AQ1.12M10440, AQ1.12M10540
- for electronic washbasin fittings AQ1.12S22040, AQ1.12S22140, AQ1.12S23040 and AQ1.12S23140



111728

HEWI Tap flow regulator dismantling key
for single lever washbasin mixer tap **AQ 100**

- for AQ1.12M10040

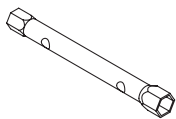

171060

HEWI Mounting key SW9 and SW11

- for fixing the washbasin fittings

Item Number

Dimensions in mm / Specification



BM1296

**HEWI Fixing material
for single lever washbasin mixer tap AQ 800, AQ 800 K,
AQ 477/801, AQ 162**
· for AQ1.12M101..., AQ1.12M102..., AQ1.12M104... and
AQ1.12M105...



BM1297

HEWI Fixing material
· for electronic washbasin fittings

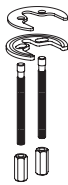

BM1300

**HEWI Fixing material
for single lever washbasin mixer tap AQ 100**
· for AQ1.12M10040



BM1302

**HEWI Fixing material
for single lever washbasin mixer tap AQ 950**
· for AQ1.12M103...

Item Number

Dimensions in mm / Specification

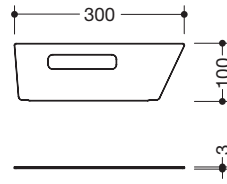
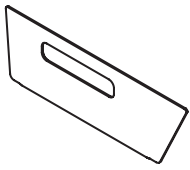

950.12.E001
950.12.E002

HEWI baffle
for row washbasin with height graduation 950.12.30...

- height 100 mm
- suitable for water play (not completely sealing)
- made of Plexiglas in blue (transparent)
- made of Plexiglas in green (opaque)

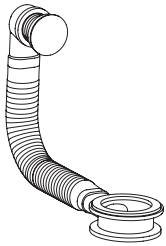

New 70498

HEWI Overflow
to replace the overflow in HEWI washbasins

- including rose and cover
- is fitted underneath the washbasin between the trap and drain, h=25 mm, ø=70 mm

57978

HEWI Repair kit
for washbasins made of mineral composite

- for all HEWI washbasin models
- colour: alpine white
- contains gelcoat, hardener, polishing compound, wooden spatula and abrasive material

