

Range: Washbasin self-closing mixer tap

Ref: 68052 - PRESTO NEO DUO S® deck-mounted tap - Dual timed-flow

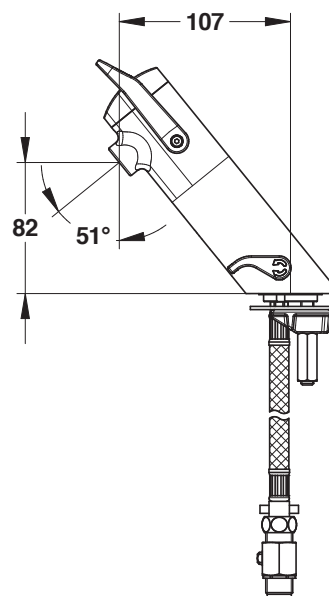

> Working pressure:

- 1 to 5 bar

> Flow:

- 3 l/min at 3 bars - 4-position setting
- Anti water-hammer system

> Flow time:

- 7 seconds - lever upwards
- 11 seconds - lever downwards

> Hydraulic supply:

- 2 PEX hoses DN8 G3/8" - 350mm

> Thermal resistance:

- This tap can withstand a thermal shock of 75°C for 30 minutes as part of a thermal shock programme

> Safety:

- With S® antiblocking system to prevent blocking in continuous flow
- With temperature limiter (at 38°C for cold water at 15°C/3 bar and hot water at 60°C/3 bar)

> Convenience:

- Soft-touch
- Two-coloured ergonomic lever, in glass fiber reinforced polymer

> Delivered with:

- 2 PEX hoses with swivel nut and NF check valves
- 1 base gasket
- 2 MM 3/8" (12x17) stop valves
- 2 Filter gaskets
- 1 Fixing bracket

> Standards / Approvals:

- Chrome-plated brass body compliant with standards NF EN1982 / NF EN12164 / NF EN12165
- Nickel-Chrome surface treatment compliant with NF EN12540
- Neutral Salt Spray (NSS) resistant: 200 h according to NF ISO 9227

