



FROST

An abstract, monochromatic graphic featuring several overlapping, elongated, metallic-looking shapes that resemble architectural hardware components like door pulls or handles. The shapes are rendered with soft gradients and highlights, creating a sense of depth and three-dimensionality against a solid black background. The overall composition is dynamic and modern.

ARCHITECTURAL HARDWARE

ARCHITECTURAL HARDWARE

FROST A WORK IN PROGRESS

Our vision and focus is to provide a broad platform of architectural elements that both inspire and provide comprehensive design and application solutions.

Our Danish culture of progressive contemporary design is conveyed through our products in a manner that blends design with function, creativity with solutions. Frost embraces the concept that Form is nothing without Function. Emphasis has been also placed on material, quality, and service.

THE STORY IS BEING TOLD AND YOU ARE PART OF IT

Frost has been the recipient of International Design Awards and have realized that our company is a Work In Progress that we attribute to the ongoing dialogue with architects worldwide that have been embraced as part of our company's culture. Frost is more than a company: it is a vision and quest for excellence.



DESIGN AND BUSINESS

WITH A PASSION

We are thrilled to introduce you to the latest additions to our current collection - our new range of ARCHITECTURAL HARDWARE.

With the emphasis on versatile design, clean lines and endless combination possibilities, this new concept creates a modern and yet timeless range of hardware such as door handles, door knobs, window handles and door stops.

We believe they give building architects and end-users a whole new set of tools to help achieve perfection in the important details of a building or a home by providing the finishing touches and functionality needed in our modern world.

We have already received national and international awards for our cutting-edge design and for being one of the most successful companies in our line of business. We are delighted and grateful that you, our valued customer, have chosen to be a part of that exciting story.

With these products, we hope that we continue to demonstrate our success as one of Denmark's fastest growing companies.

Please visit us on www.frostdesign.dk



CONTENTS

SO YOU CAN FIND YOUR WAY

Door Handles and Door Knobs p9

Escutcheons p49

Window Handles p69

Door Stops p93

Push-Pull Handles p103

Accessories p111

Designers p114

Index p116



DOOR HANDLES AND KNOBS

THE NEW HB100 SERIES

Two new door lever handles have been developed by Frost in collaboration with Danish design firm Bonnellycke MDD. This new architectural door hardware program embraces progressive design, material, function with a tactile quality.





A1007B - brushed

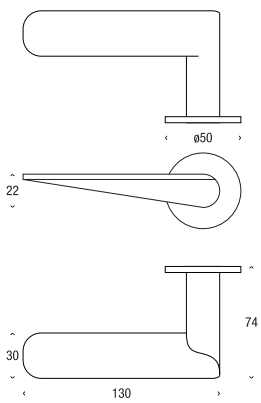



A1007P - polished

HB101 DOOR

Material: Stainless Steel in brushed or polished.

What is in the box: A pair of lever handles 30 x 22 mm with cover roses attached. Ø50 x 4mm round rose covers with concealed screws.

Machine screws (torx 15) M4 x 62 mm + M4 x 35mm break-off. Wood screws 4,5 x 16 mm. Plastic tube plug. Allen Key 2,5 mm. Rose key. Bushes.

Design: Bønnelycke mdd.



A1007SB - brushed

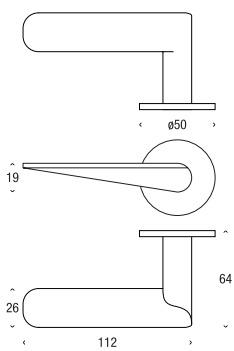



A1007SP - polished

HB101 DOOR SMALL

Material: Stainless steel in brushed or polished.

What is in the box: A pair of lever handles 26 x 19 mm with cover roses attached. Ø50 x 4 mm round rose covers with concealed screws.

Machine screws (torx 15) M4 x 62 mm + M4 x 35mm break-off. Wood screws 4,5 x 16 mm. Plastic tube plug. Allen Key 2,5 mm. Rose key. Bushes.

Design: Bønnelycke mdd.



A1008B - brushed

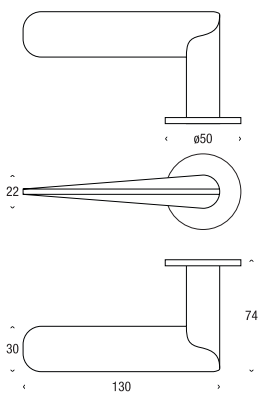



A1008P - polished

HB102 DOOR

Material: Stainless Steel in brushed or polished.

What is in the box: A pair of lever handles 30 x 22 mm with cover roses attached. Ø50 x 4 mm round rose covers with concealed screws.

Machine screws (torx 15) M4 x 62 mm + M4 x 35mm break-off. Wood screws 4,5 x 16 mm. Plastic tube plug. Allen Key 2,5 mm. Rose key. Bushes.

Design: Bønnelycke mdd.

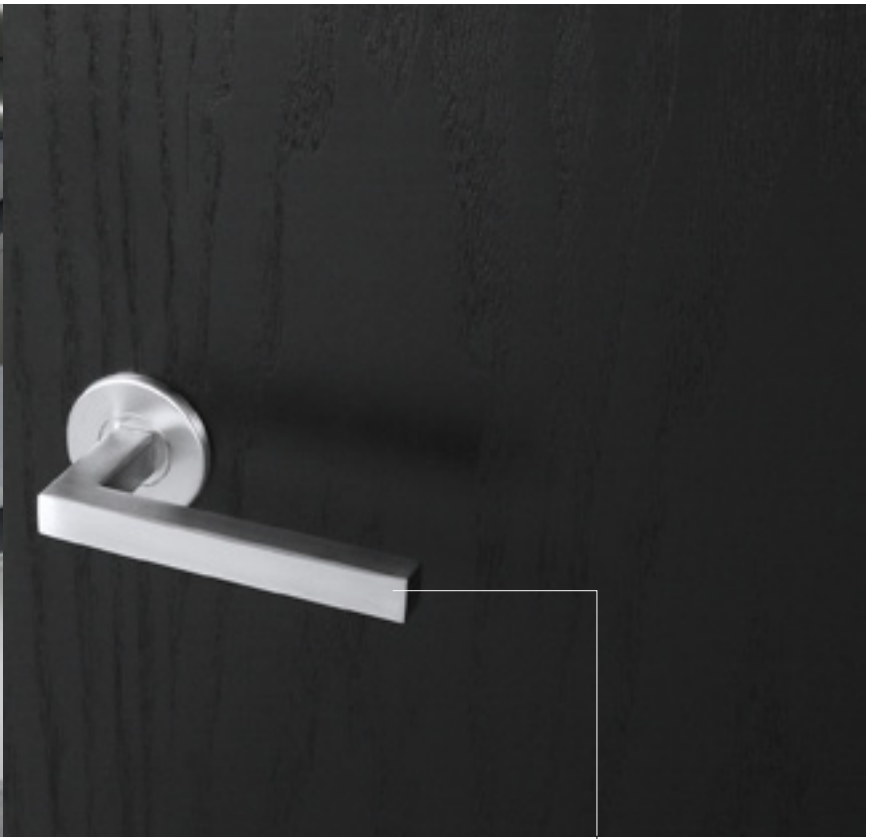

A1001B - brushed

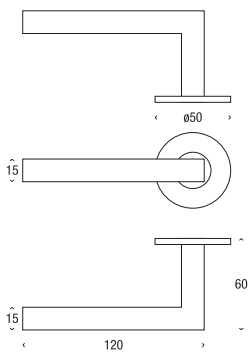



A1001P - polished

ELEMENT 1001

Material: Stainless steel in brushed or polished.

What is in the box: A pair of lever handles 15 x 15 mm with cover roses attached. Ø50 x 4 mm round rose covers with concealed screws.

Machine screws (torx 15) M4 x 62 mm + M4 x 35mm break-off. Wood screws 4,5 x 16 mm. Plastic tube plug. Allen Key 2,5 mm. Rose key. Bushes.

Design: Busk+Herzog

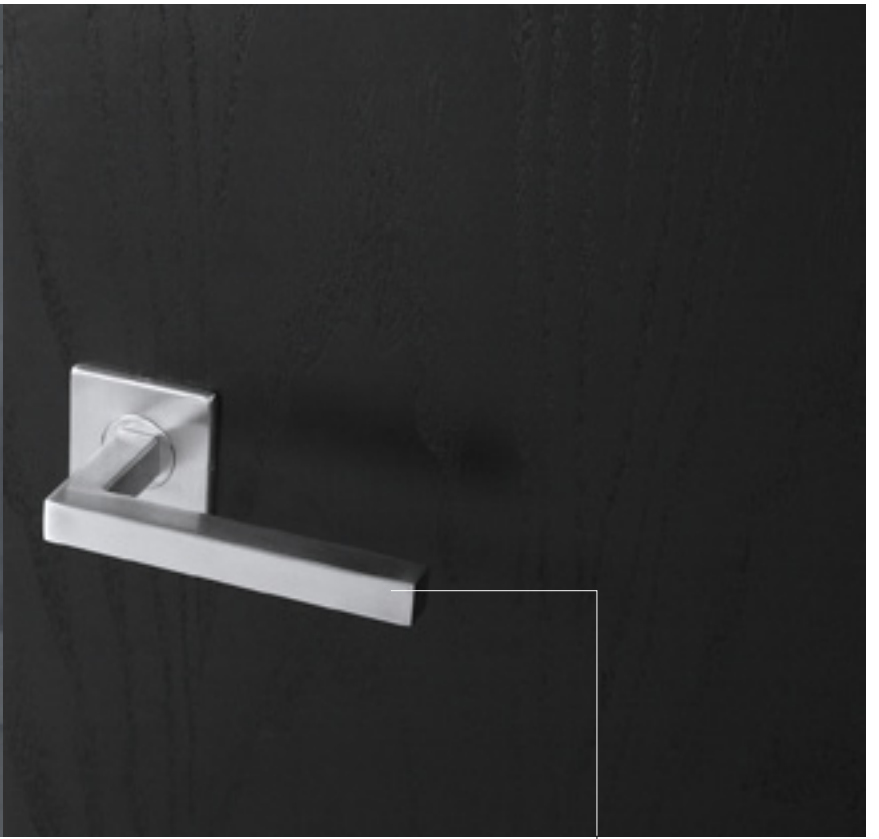
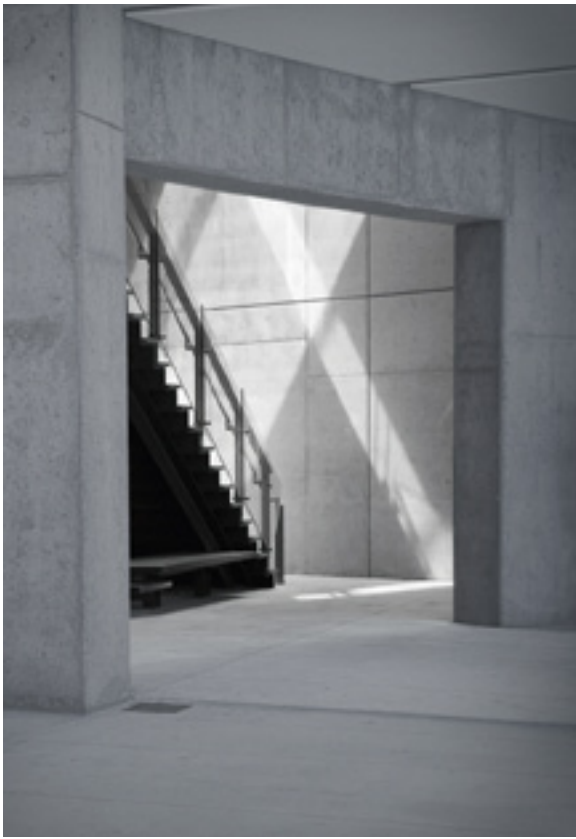

A1001BS - brushed

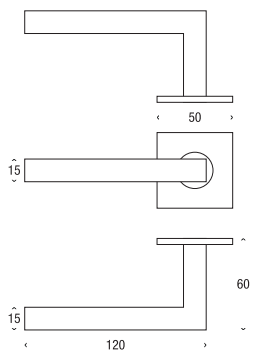



A1001PS - polished

KUBE 1001

Material: Stainless steel in brushed or polished.

What is in the box: A pair of lever handles 15 x 15 mm with cover roses attached. 50 x 50 x 4 mm square rose covers with concealed screws.

Machine screws (torx 15) M4 x 62 mm + M4 x 35mm break-off. Wood screws 4,5 x 16 mm. Plastic tube plug. Allen Key 2,5 mm. Rose key. Bushes.

Design: Busk+Herzog



A1002BS - brushed

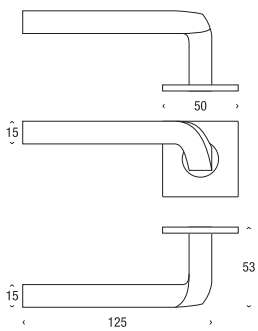



A1002PS - polished

KUBE 1002

Material: Stainless steel in brushed or polished.

What is in the box: A pair of cranked lever handles 15 x 15 mm with cover roses attached. 50 x 50 x 4 mm square rose covers with concealed screws. Machine screws (torx 15) M4 x 62 mm + M4 x 35mm break-off. Wood screws 4,5 x 16 mm. Plastic tube plug. Allen Key 2,5 mm. Rose key. Bushes.

Design: Busk+Hertzog

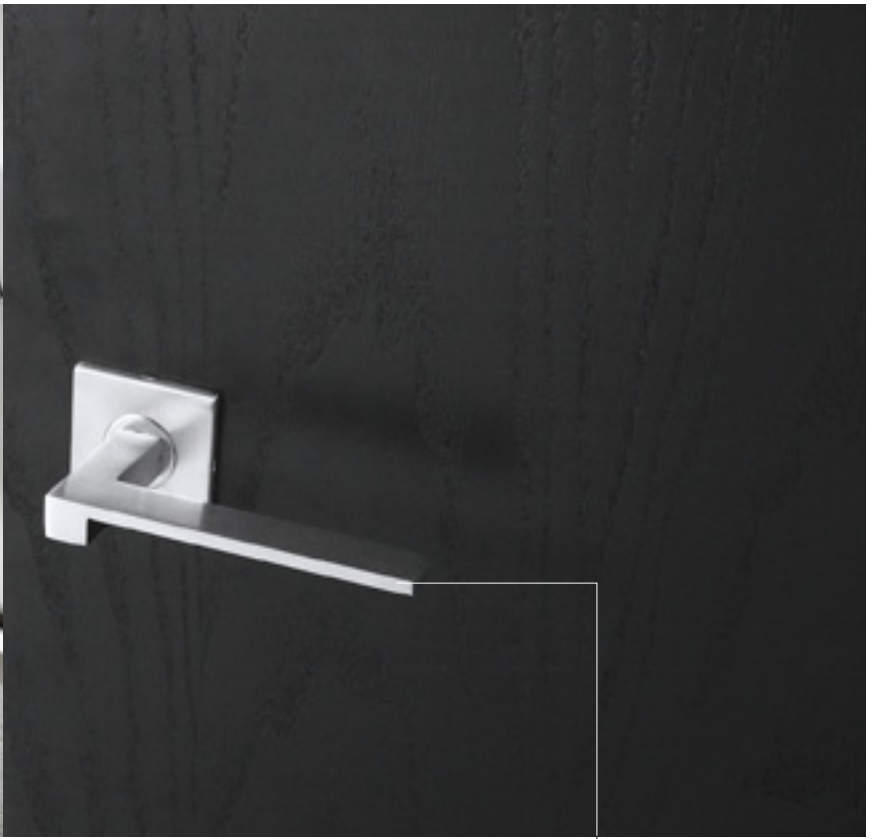

A1003BS - brushed

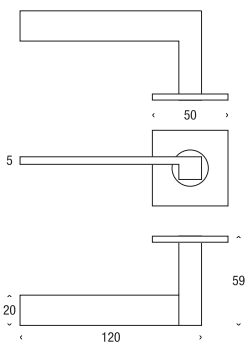



A1003PS - polished

KUBE 1003

Material: Stainless steel in brushed or polished.

What is in the box: A pair of lever handles 15 x 5 x 20 mm with cover roses attached. 50 x 50 x 4 mm square rose covers with concealed screws. Machine screws (torx 15) M4 x 62 mm + M4 x 35mm break-off. Wood screws 4,5 x 16 mm. Plastic tube plug. Allen Key 2,5 mm. Rose key. Bushes.

Design: Busk+Hertzog

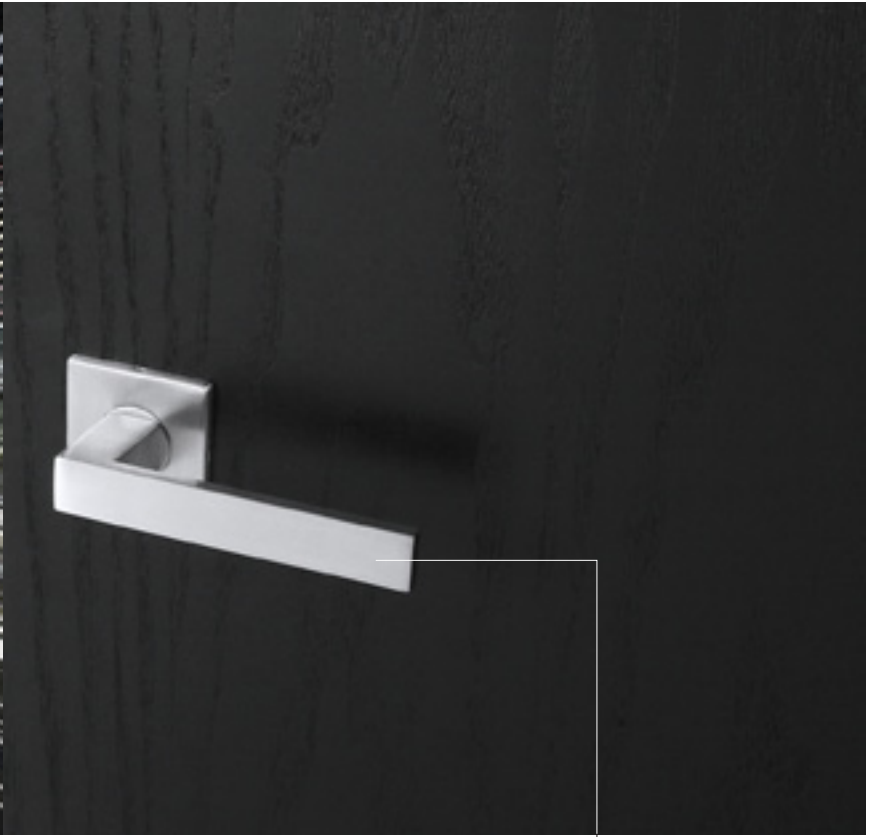

A1004BS - brushed

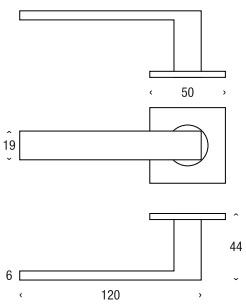



A1004PS - polished

KUBE 1004

Material: Stainless steel in brushed or polished.

What is in the box: A pair of lever handles 19 x 6 mm with cover roses attached. 50 x 50 x 4 mm square rose covers with concealed screws. Machine screws (torx 15) M4 x 62 mm + M4 x 35mm break-off. Wood screws 4,5 x 16 mm. Plastic tube plug. Allen Key 2,5 mm. Rose key. Bushes.

Design: Busk+Hertzog



A1005BS - brushed

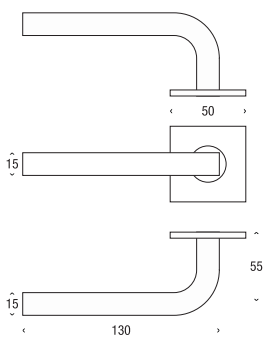



A1005PS - polished

KUBE 1005

Material: Stainless steel in brushed or polished.

What is in the box: A pair of lever handles 15 x 15 mm with cover roses attached. 50 x 50 x 4 mm square rose covers with concealed screws.

Machine screws (torx 15) M4 x 62 mm + M4 x 35mm break-off. Wood screws 4,5 x 16 mm. Plastic tube plug. Allen Key 2,5 mm. Rose key. Bushes.

Design: Busk+Hertzog



A1006BS - brushed

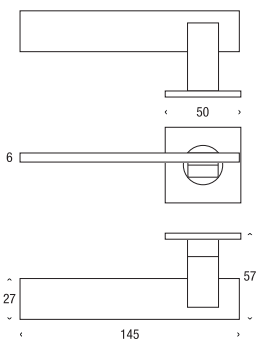



A1006PS - polished

KUBE 1006

Material: Stainless steel in brushed or polished.

What is in the box: A pair of lever handles 27 x 5 mm with cover roses attached. 50 x 50 x 4 mm square rose covers with concealed screws.

Machine screws (torx 15) M4 x 62 mm + M4 x 35mm break-off. Wood screws 4,5 x 16 mm. Plastic tube plug. Allen Key 2,5 mm. Rose key. Bushes.

Design: Busk+Hertzog

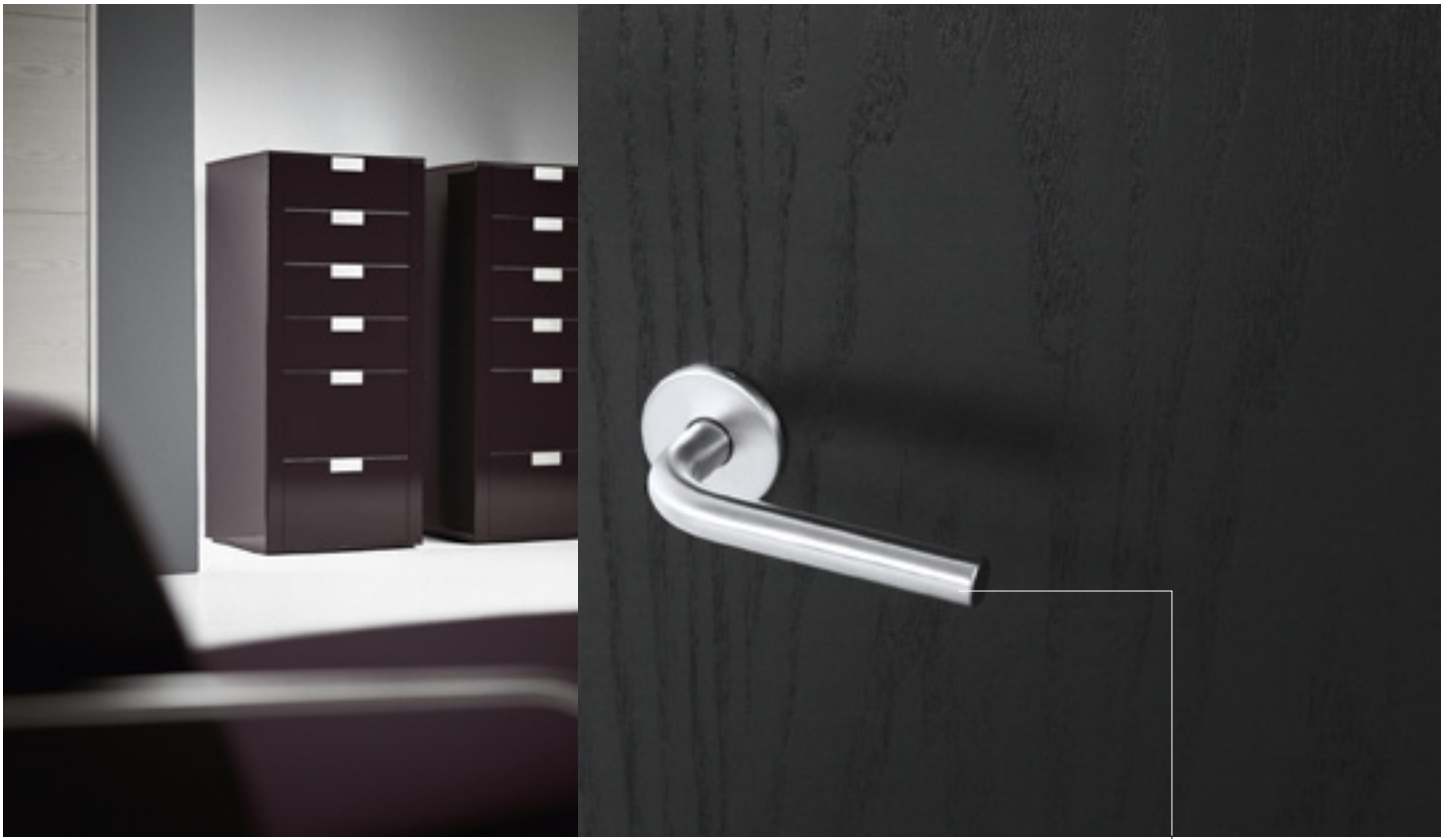

A1051B - brushed

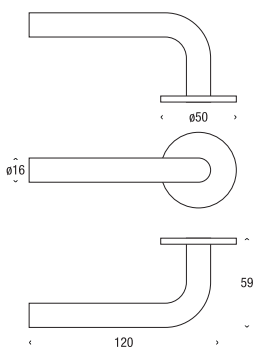



A1051P - polished

TUBE 1051

Material: Stainless steel in brushed or polished.

What is in the box: A pair of lever handles $\varnothing 16$ mm with cover roses attached. $\varnothing 50 \times 4$ mm round rose covers with concealed screws.

Machine screws (torx 15) M4 x 62 mm + M4 x 35mm break-off. Wood screws 4,5 x 16 mm. Plastic tube plug. Allen Key 2,5 mm. Rose key. Bushes.

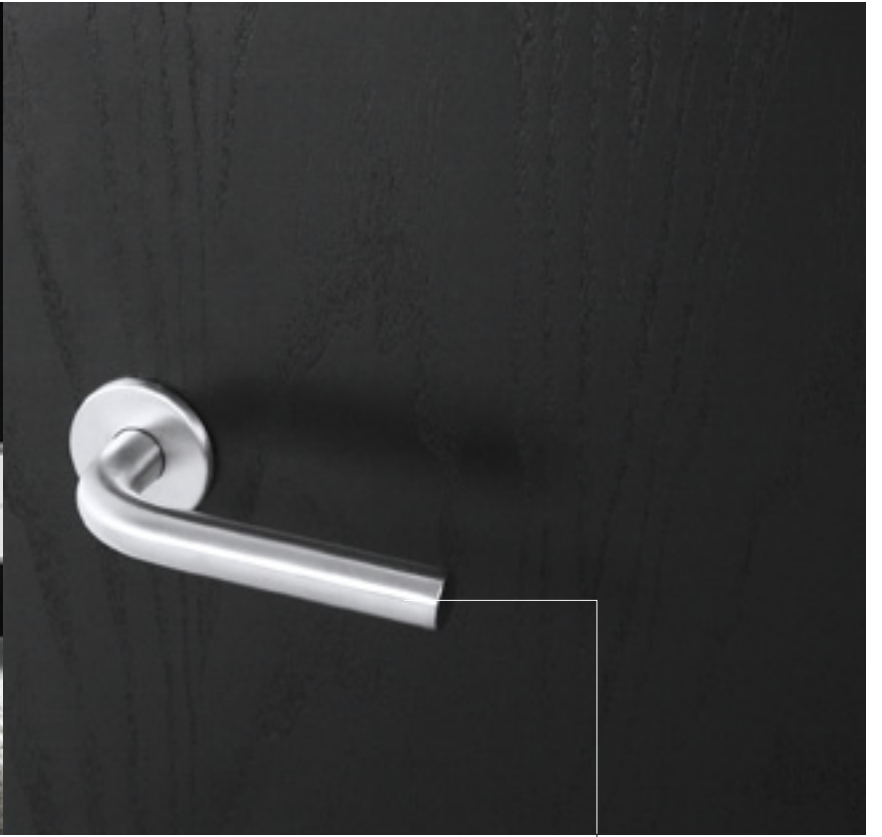

A1052B - brushed

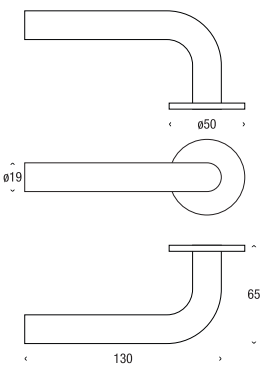



A1052P - polished

TUBE 1052

Material: Stainless steel in brushed or polished.

What is in the box: A pair of lever handles Ø19 mm with cover roses attached. Ø50 x 4 mm round rose covers with concealed screws.

Machine screws (torx 15) M4 x 62 mm + M4 x 35mm break-off. Wood screws 4,5 x 16 mm. Plastic tube plug. Allen Key 2,5 mm. Rose key. Bushes.



A1053B - brushed

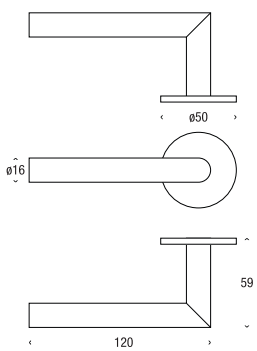



A1053P - polished

ELEMENT 1053

Material: Stainless steel in brushed or polished.

What is in the box: A pair of lever handles $\varnothing 16$ mm with cover roses attached. $\varnothing 50 \times 4$ mm round rose covers with concealed screws.

Machine screws (torx 15) M4 x 62 mm + M4 x 35mm break-off. Wood screws 4,5 x 16 mm. Plastic tube plug. Allen Key 2,5 mm. Rose key. Bushes.

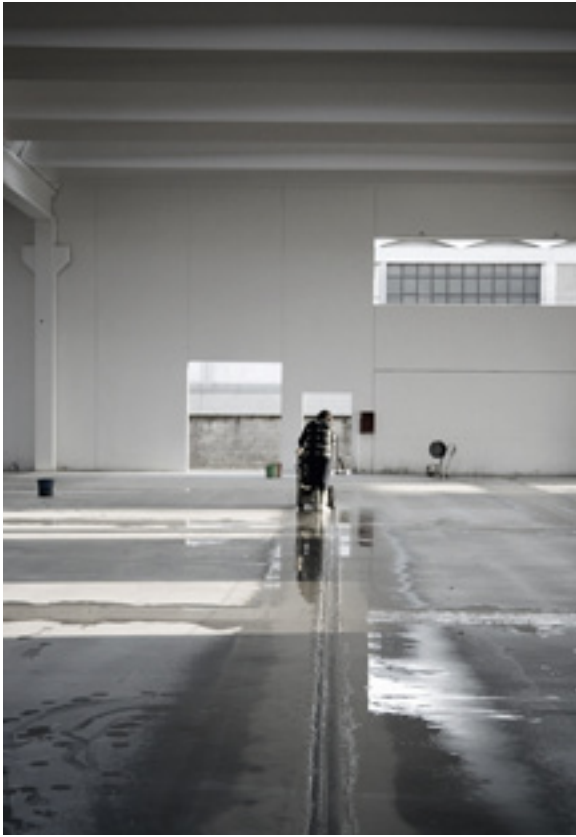

A1053BS - brushed

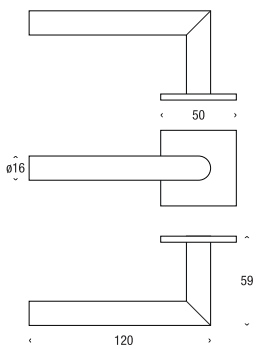



A1053PS - polished

KUBE 1053

Material: Stainless steel in brushed or polished.

What is in the box: A pair of lever handles Ø16 mm with cover roses attached. 50 x 50 x 4 mm square rose covers with concealed screws.

Machine screws (torx 15) M4 x 62 mm + M4 x 35mm break-off. Wood screws 4,5 x 16 mm. Plastic tube plug. Allen Key 2,5 mm. Rose key. Bushes.



A1054B - brushed

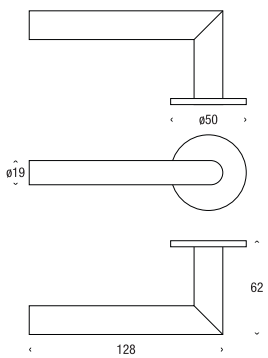

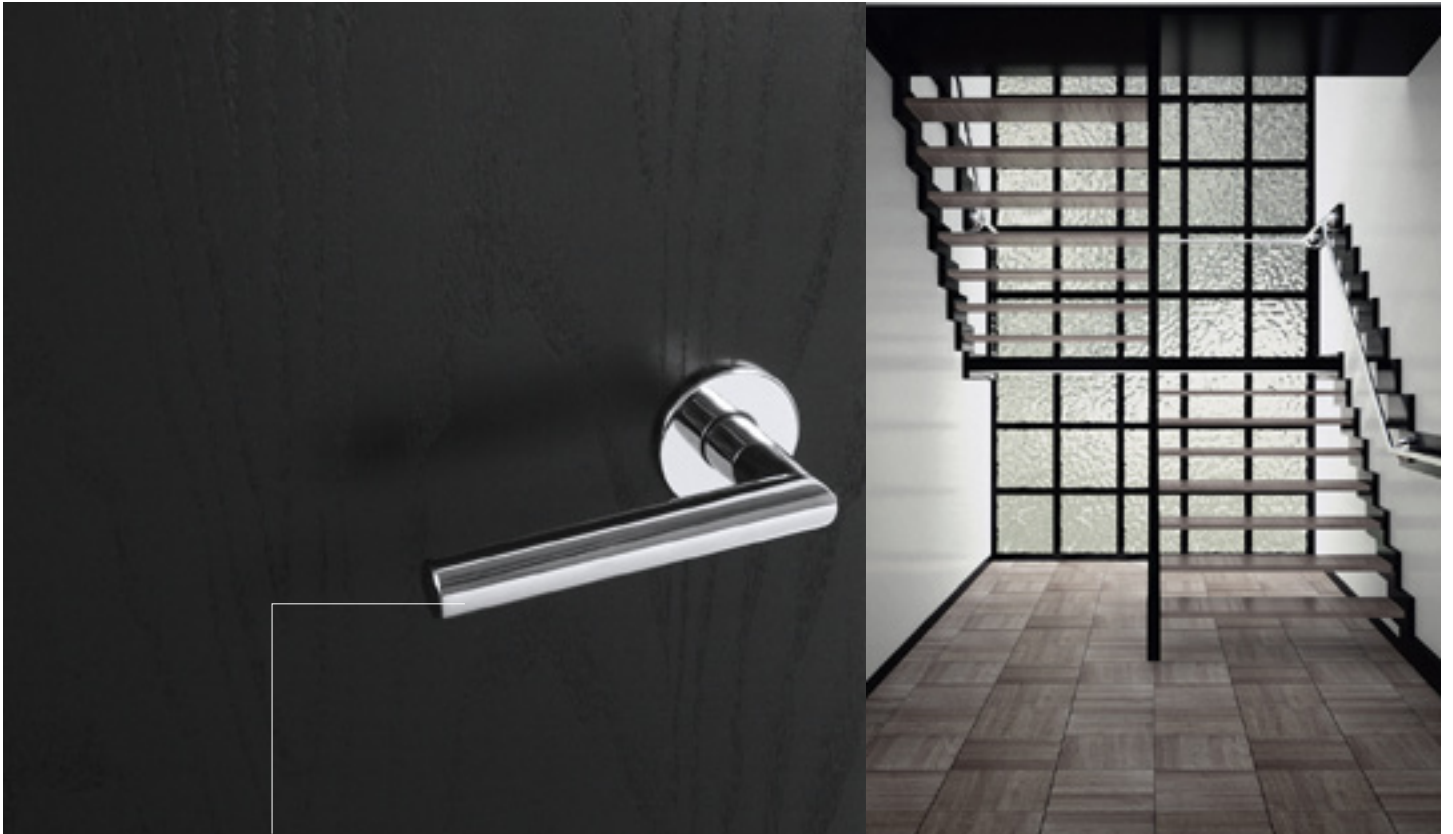

A1054P - polished

ELEMENT 1054

Material: Stainless steel in brushed or polished.

What is in the box: A pair of lever handles $\varnothing 19$ mm with cover roses attached. $\varnothing 50 \times 4$ mm round rose covers with concealed screws.

Machine screws (torx 15) M4 x 62 mm + M4 x 35mm break-off. Wood screws 4,5 x 16 mm. Plastic tube plug. Allen Key 2,5 mm. Rose key. Bushes.



A1054BS - brushed

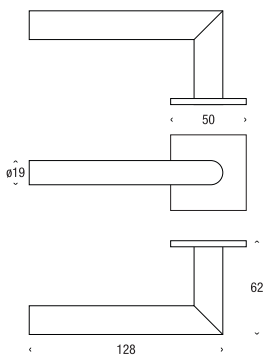



A1054PS - polished

KUBE 1054

Material: Stainless steel in brushed or polished.

What is in the box: A pair of lever handles Ø19 mm with cover roses attached. 50 x 50 x 4 mm square rose covers with concealed screws.

Machine screws (torx 15) M4 x 62 mm + M4 x 35mm break-off. Wood screws 4,5 x 16 mm. Plastic tube plug. Allen Key 2,5 mm. Rose key. Bushes.



A6001BS - brushed

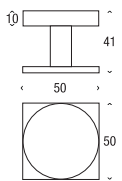



A6001PS - polished

DOOR KNOB KUBE 6001 (NOT TURNABLE)

Material: Stainless steel in brushed or polished.

What is in the box: Door knob $\varnothing 50 \times 10$ mm with rose attached. $50 \times 50 \times 4$ mm square rose cover with concealed screws. (Screw holes CC 38 mm).

Design: Busk+Hertzog



A6002BS - brushed

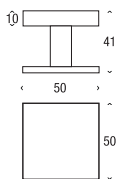

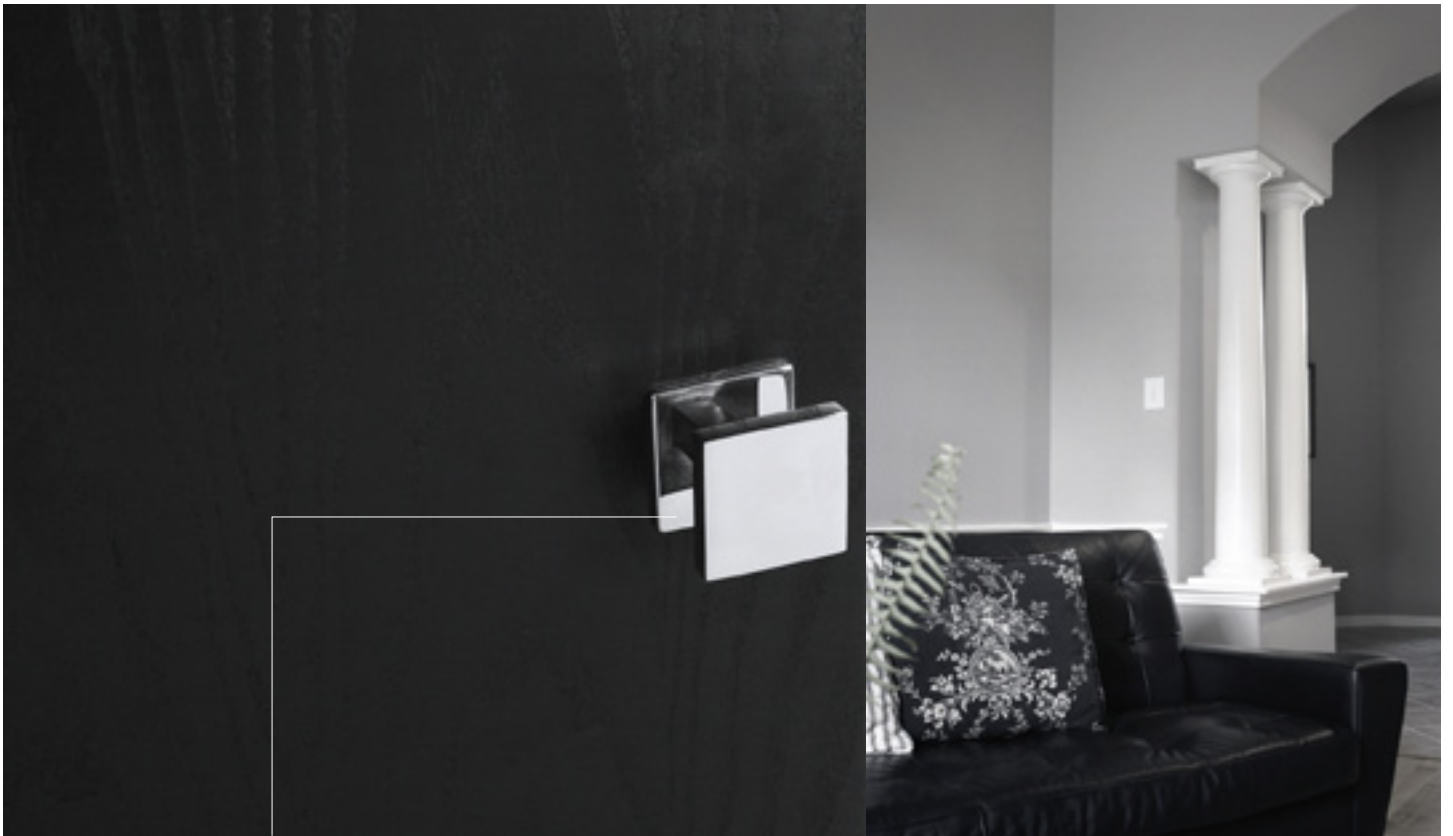

A6002PS - polished

DOOR KNOB KUBE 6002 (NOT TURNABLE)

Material: Stainless steel in brushed or polished.

What is in the box: Door knob 50 x 50 x 10 mm with rose attached. 50 x 50 x 4 mm square rose cover with concealed screws. (Screw holes CC 38 mm).

Design: Busk+Hertzog



A6003BS - brushed

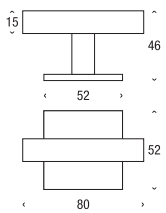



A6003PS - polished

DOOR KNOB KUBE 6003 (NOT TURNABLE)

Material: Stainless steel in brushed or polished.

What is in the box: Door knob 15 x 15 x 80 mm with rose attached. 50 x 50 x 4 mm square rose cover with concealed screws. (Screw holes CC 38 mm).

Design: Busk+Hertzog



ESCUTCHEONS

FOR PRIVACY...

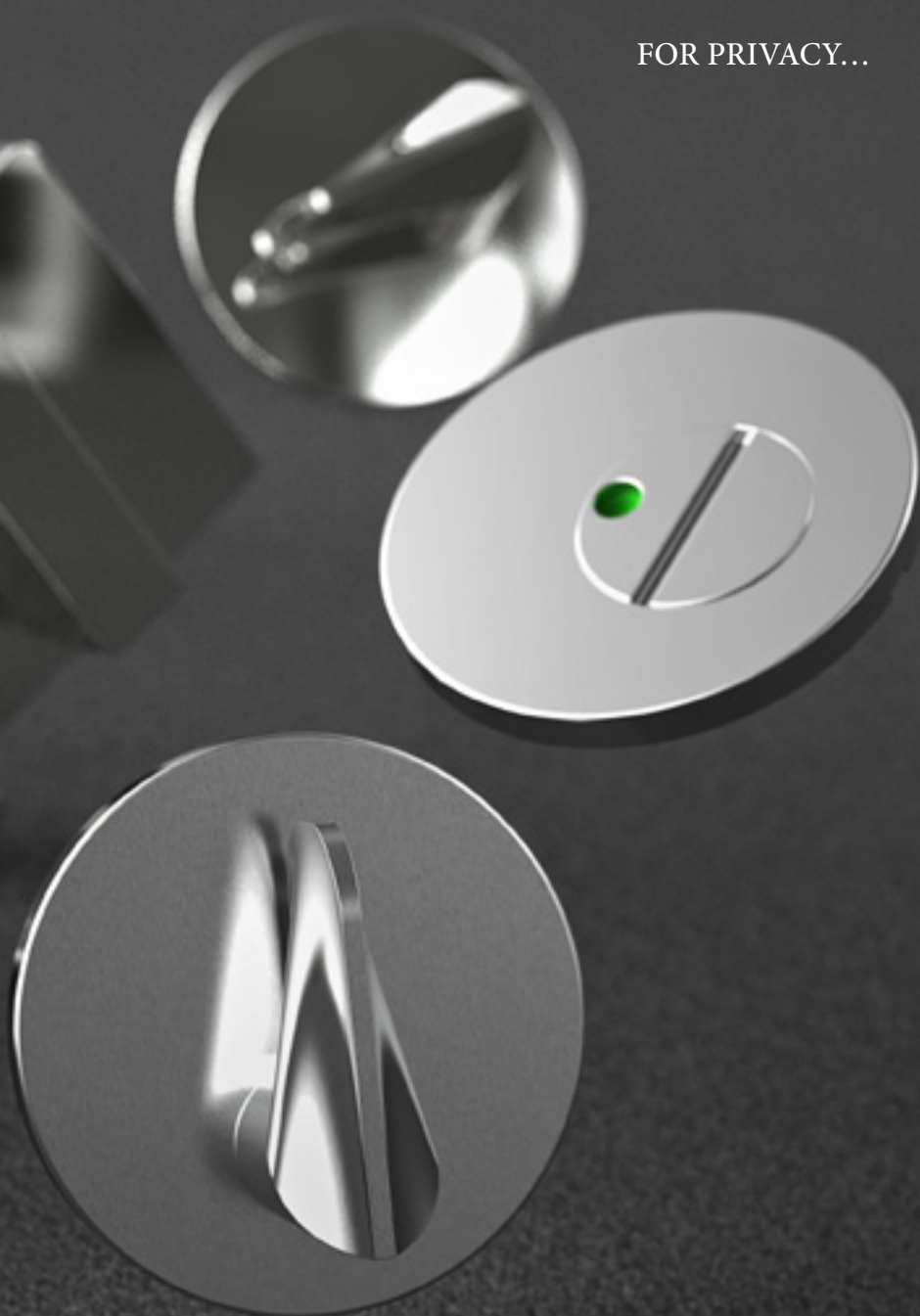

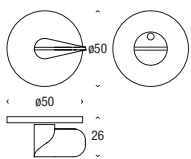
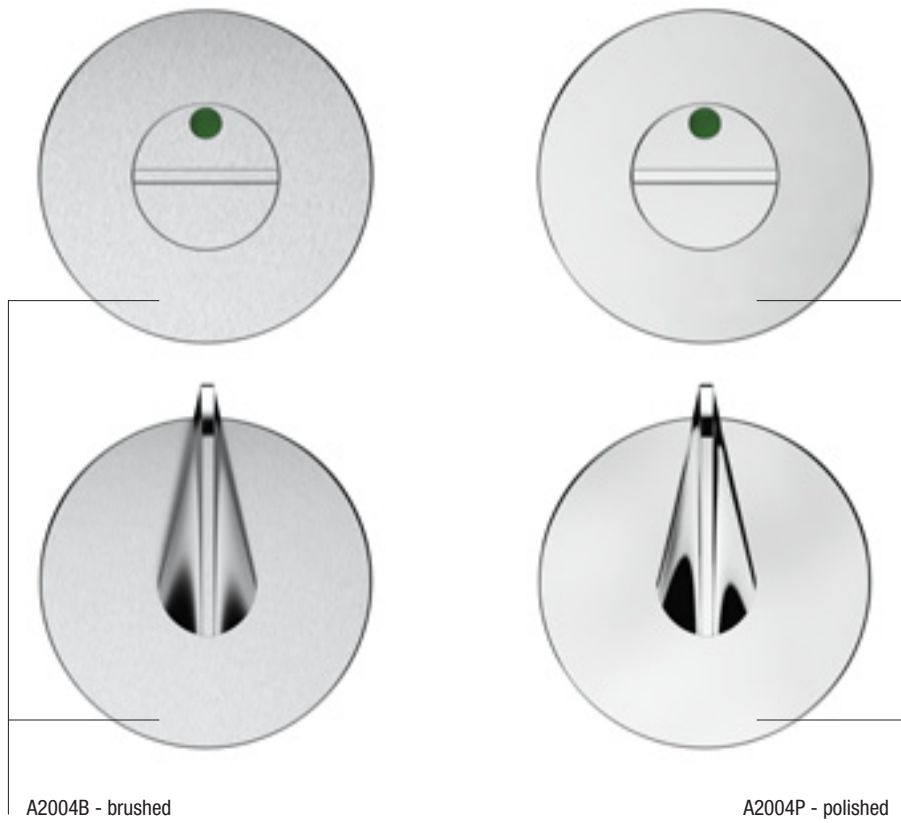

HB202

Material: Stainless steel in brushed or polished.

What is in the box: Escutcheon set with roses attached. Ø50 x 4 mm round rose covers with concealed screws.

Turn and red / green indicator sides. Machine screws (torx 15) M4 x 62 + M4 x 35 mm break-off. Wood screws 4,5 x 16 mm. Bushes.

Plastic tube plug. Allen key 2,5 mm. Spindle 5 x 5 x 53 mm.

Design: Bønnelycke mdd.

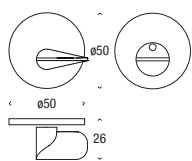
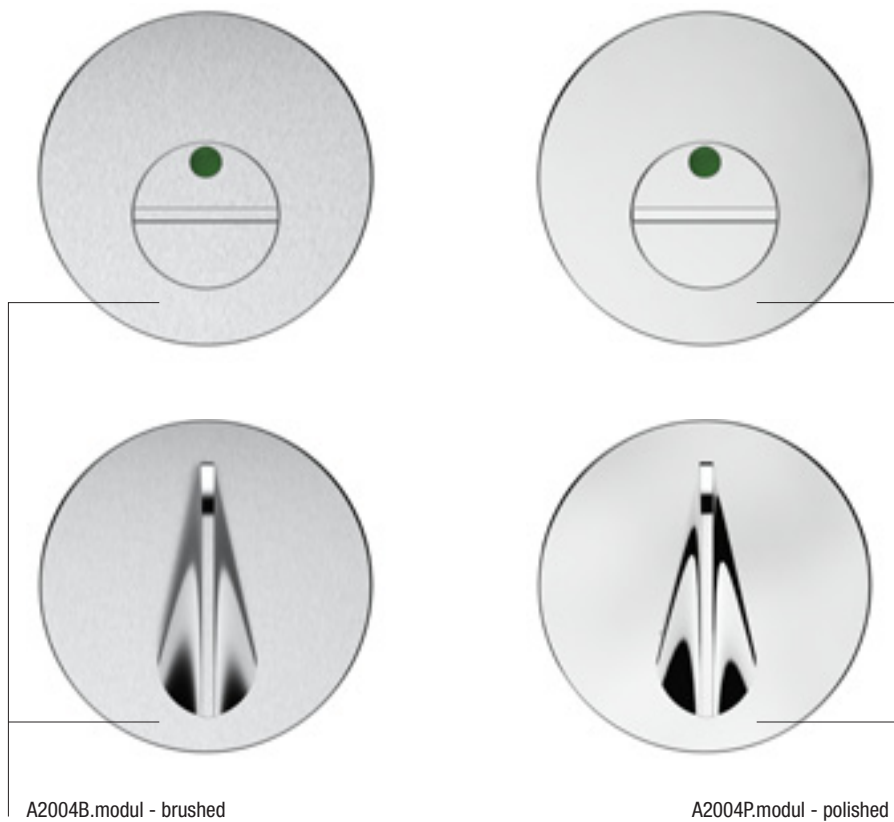

HB202 MODUL

Material: Stainless steel in brushed or polished.

What is in the box: Escutcheon set with roses attached. Ø50 x 4 mm round rose covers with concealed screws.

Turn and red / green indicator sides. Machine screws (torx 15) M4 x 62 + M4 x 35 mm break-off. Wood screws 4,5 x 16 mm. Bushes.

Plastic tube plug. Allen key 2,5 mm. Spindle 5 x 5 x 53 mm.

Design: Bønnelycke mdd.



A2001BS - brushed

A2001PS - polished

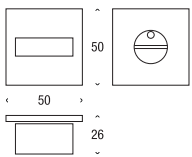

KUBE 2001

Material: Stainless steel in brushed or polished.

What is in the box: Escutcheon set with roses attached. 50 x 50 x 4 mm square rose covers with concealed screws.

Turn and red / green indicator sides. Machine screws (torx 15) M4 x 62 + M4 x 35 mm break-off. Wood screws 4,5 x 16 mm. Bushes.

Plastic tube plug. Allen key 2,5 mm. Spindle 5 x 5 x 53 mm.

Design: Busk+Hertzog.

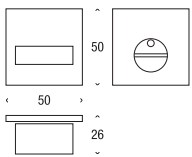
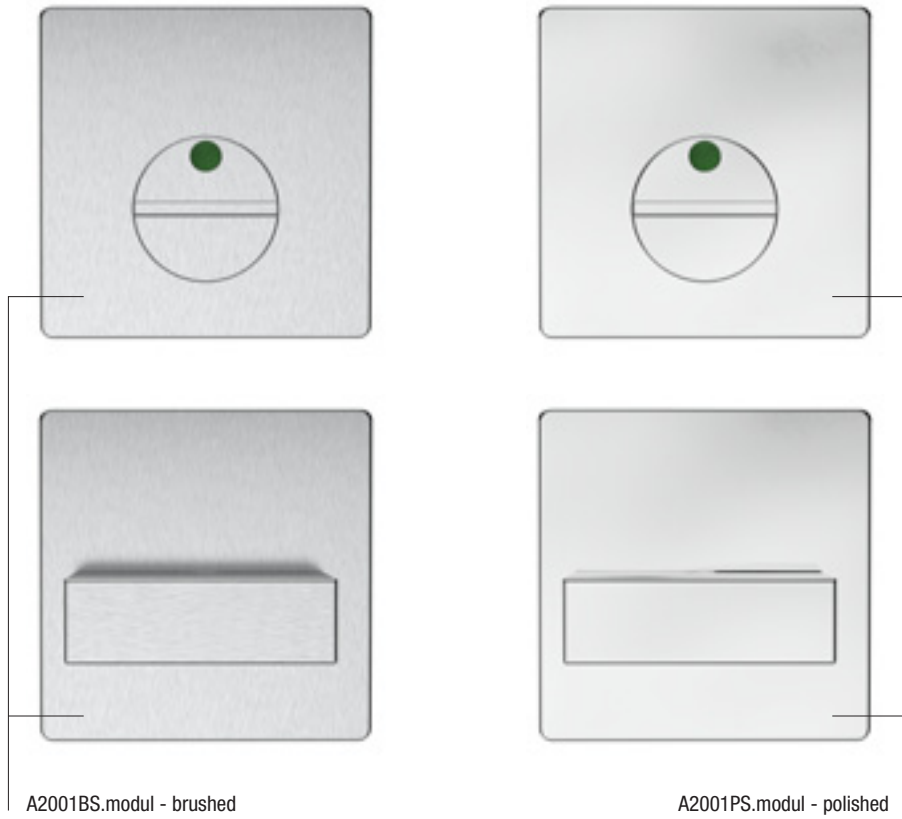

KUBE 2001 MODUL

Material: Stainless steel in brushed or polished.

What is in the box: Escutcheon set with roses attached. 50 x 50 x 4 mm square rose covers with concealed screws.

Turn and red / green indicator sides. Machine screws (torx 15) M4 x 62 + M4 x 35 mm break-off. Wood screws 4,5 x 16 mm. Bushes.

Plastic tube plug. Allen key 2,5 mm. Spindle 5 x 5 x 53 mm.

Design: Busk+Hertzog.



A2002BS - brushed

A2002PS - polished

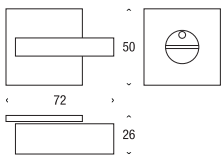

KUBE 2002

Material: Stainless steel in brushed or polished.

What is in the box: Escutcheon set for disabled with roses attached. 50 x 50 x 4 mm square rose covers with concealed screws.

Turn and red / green indicator sides. Machine screws (torx 15) M4 x 62 + M4 x 35 mm break-off. Wood screws 4,5 x 16 mm. Bushes.

Plastic tube plug. Allen key 2,5 mm. Spindle 5 x 5 x 53 mm.



A2003BS - brushed

A2003PS - polished

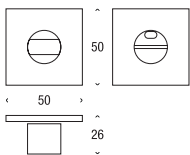

KUBE 2003

Material: Stainless steel in brushed or polished.

What is in the box: Escutcheon set with roses attached. 50 x 50 x 4 mm square rose covers with concealed screws.

Turn and red / green indicator sides. Machine screws (torx 15) M4 x 62 + M4 x 35 mm break-off. Wood screws 4,5 x 16 mm. Bushes.

Plastic tube plug. Allen key 2,5 mm. Spindle 5 x 5 x 53 mm.

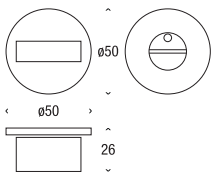
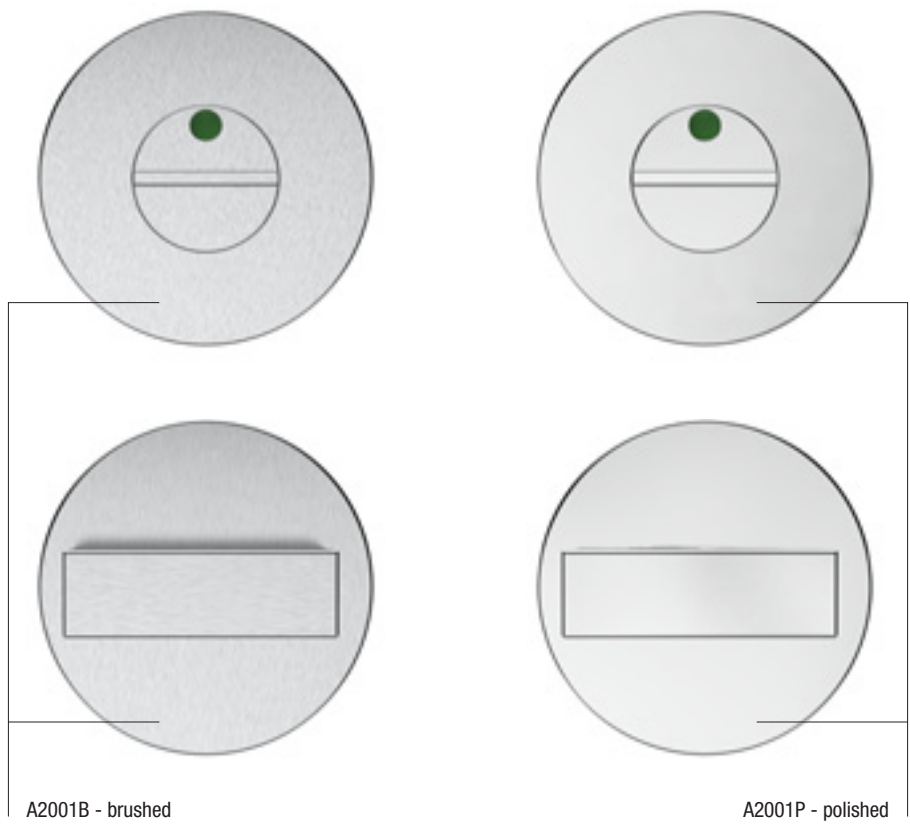

ELEMENT 2001

Material: Stainless steel in brushed or polished.

What is in the box: Escutcheon set with roses attached. Ø50 x 4 mm round rose covers with concealed screws.

Turn and red / green indicator sides. Machine screws (torx 15) M4 x 62 + M4 x 35 mm break-off. Wood screws 4,5 x 16 mm. Bushes.

Plastic tube plug. Allen key 2,5 mm. Spindle 5 x 5 x 53 mm.

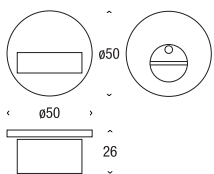
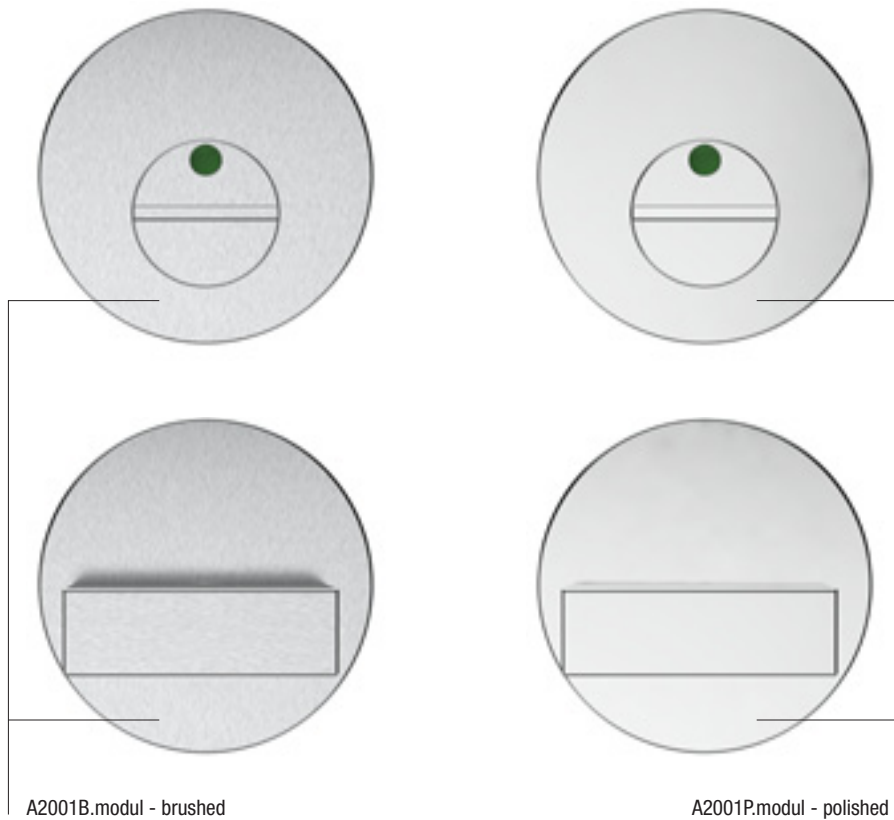

ELEMENT 2001 MODUL

Material: Stainless steel in brushed or polished.

What is in the box: Escutcheon set with roses attached. $\varnothing 50 \times 4$ mm round rose covers with concealed screws.

Turn and red / green indicator sides. Machine screws (torx 15) M4 x 62 + M4 x 35 mm break-off. Wood screws 4,5 x 16 mm. Bushes.

Plastic tube plug. Allen key 2,5 mm. Spindle 5 x 5 x 53 mm.



A2003B - brushed

A2003P - polished

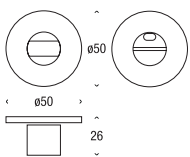

ELEMENT 2003

Material: Stainless steel in brushed or polished.

What is in the box: Escutcheon set with roses attached. Ø50 x 4 mm round rose covers with concealed screws.

Turn and red / green indicator sides. Machine screws (torx 15) M4 x 62 + M4 x 35 mm break-off. Wood screws 4,5 x 16 mm. Bushes.

Plastic tube plug. Allen key 2,5 mm. Spindle 5 x 5 x 53 mm.



A3007BS - brushed



A3007PS - polished

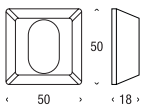

KUBE 3007

Material: Stainless steel in brushed or polished.

What is in the box - A3007: One safety cylinder for ASSA. 50 x 50 x 18 mm square rose covers with concealed screws and round fitted back plate.

Machine screws (torx 15) M4 x 62 + M4 x 35 mm break-off. Wood screws 4,5 x 16 mm. Plastic tube plug. Rose key. Bushes.

What is in the box - A3051: A pair of square replacement cover roses for lever handles. 50 x 50 x 4 mm plate. 2 break-off screws, bushes and woods crews.

Design: Busk+Hertzog.

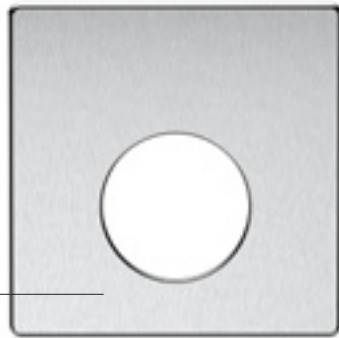

A3006BS - brushed

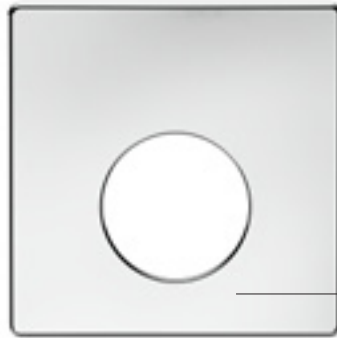

A3006PS - polished

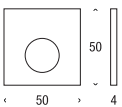

KUBE KABA 3006

Material: Stainless steel in brushed or polished.

What is in the box - A3006: A pair of Kaba roses. 50 x 50 x 4 mm square rose covers with concealed screws and round fitted back plate. Machine screws (torx 15) M4 x 62 + M4 x 35 mm break-off. Wood screws 4,5 x 16 mm. Plastic tube plug. Rose key. Bushes.

What is in the box - A3051: A pair of square replacement cover roses for lever handles. 50 x 50 x 4 mm plate. 2 break-off screws, bushes and woods crews.

Design: Busk+Hertzog.

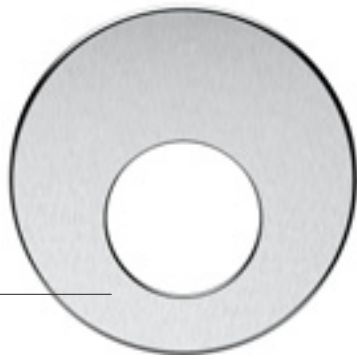

A3006B - brushed

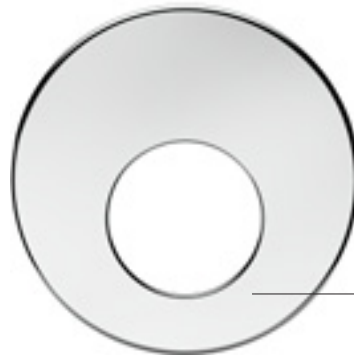

A3006P - polished

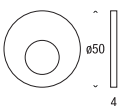

ELEMENT KABA 3006

Material: Stainless steel in brushed or polished.

What is in the box - A3006: A pair of Kaba roses. $\varnothing 50 \times 4$ mm round rose covers with concealed screws and round fitted back plate.

Machine screws (torx 15) M4 x 62 + M4 x 35 mm break-off. Wood screws 4,5 x 16 mm. Plastic tube plug. Rose key. Bushes.

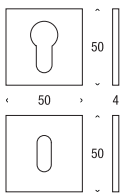

KUBE 3001 / 3002

Material: Stainless steel in brushed or polished.

What is in the box: A pair of roses. 50 x 50 x 4 mm square rose covers with concealed screws and round fitted back plate.

Machine screws (torx 15) M4 x 62 + M4 x 35 mm break-off. Wood screws 4,5 x 16 mm. Plastic tube plug. Rose key. Bushes.

Design: Busk+Hertzog.

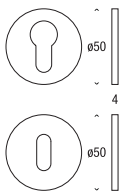
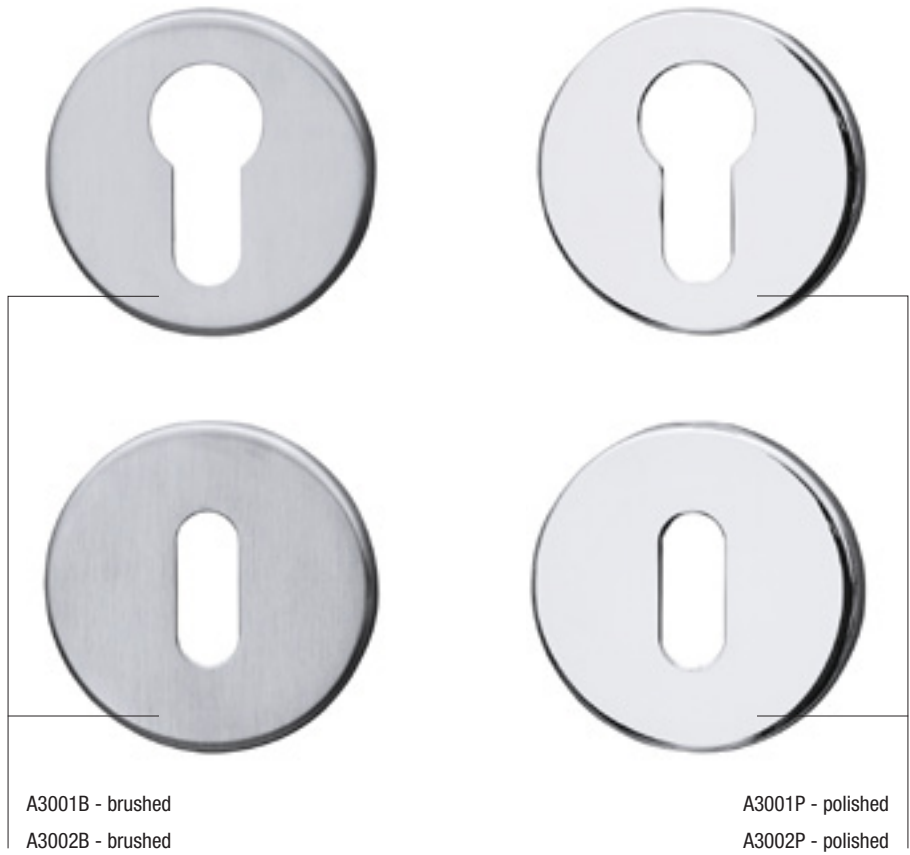

ELEMENT 3001 / 3002

Material: Stainless steel in brushed or polished.

What is in the box: A pair of roses. $\varnothing 50 \times 4$ mm round rose covers with concealed screws and round fitted back plate.

Machine screws (torx 15) M4 x 62 + M4 x 35 mm break-off. Wood screws 4,5 x 16 mm. Plastic tube plug. Rose key. Bushes.

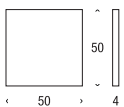
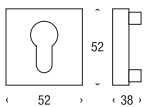

KUBE 3003 / 3004

Material: Stainless steel in brushed or polished.

What is in the box - A3003: Safety roses 52 x 52 x 11 mm with square rose covers and concealed screws. For door thickness 40-69 mm. $\varnothing 5,5 \times 70 \text{ mm} + \varnothing 5,5 \times 45 \text{ mm}$ bolts (torx 25).

What is in the box - A3004: A pair of roses. 50 x 50 x 4 mm square rose covers with concealed screws and round fitted back plate. Machine screws (torx 15) M4 x 62 + M4 x 35 mm break-off. Wood screws 4,5 x 16 mm. Plastic tube plug. Rose key. Bushes.

Design: Busk+Hertzog.

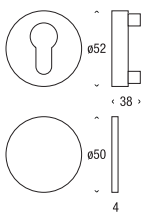
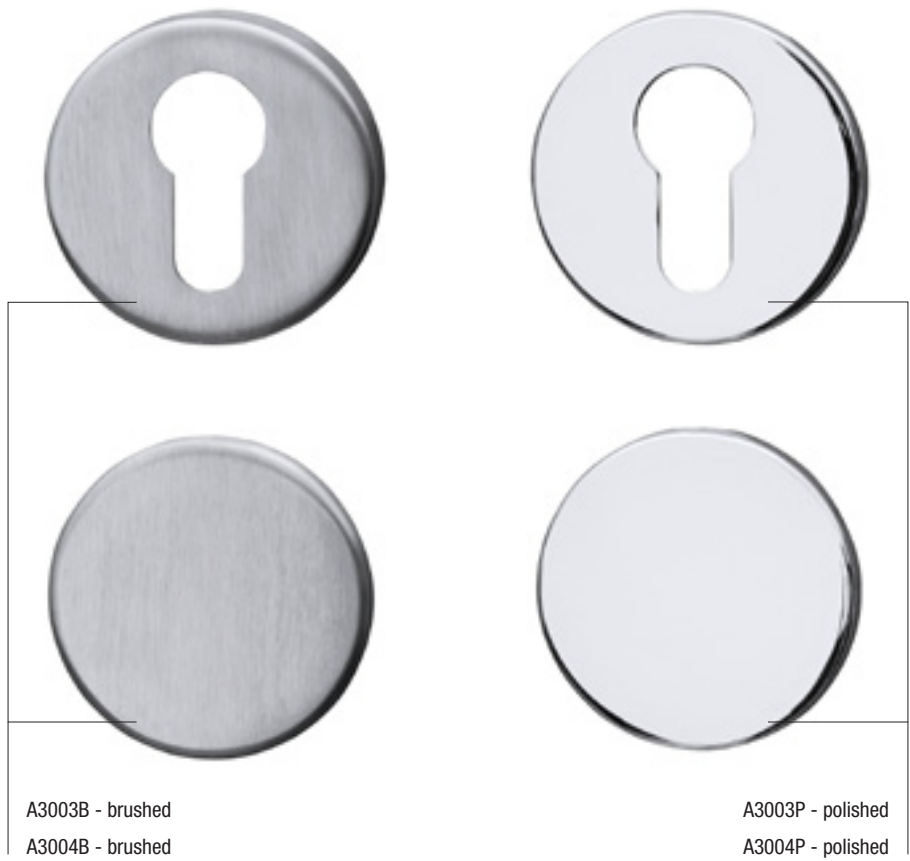

ELEMENT 3003 / 3004

Material: Stainless steel in brushed or polished.

What is in the box - A3003: Safety roses $\varnothing 52 \times 11$ mm with round rose covers and concealed screws. For door thickness 40-69 mm.
 $\varnothing 5,5 \times 70$ mm + $\varnothing 5,5 \times 45$ mm bolts (torx 25).

What is in the box - A3004: A pair of roses. $\varnothing 50 \times 4$ mm round rose covers with concealed screws and round fitted back plate.
Machine screws (torx 15) M4 x 62 + M4 x 35 mm break-off. Wood screws 4,5 x 16 mm. Plastic tube plug. Rose key. Bushes.

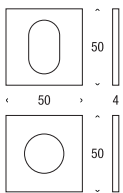
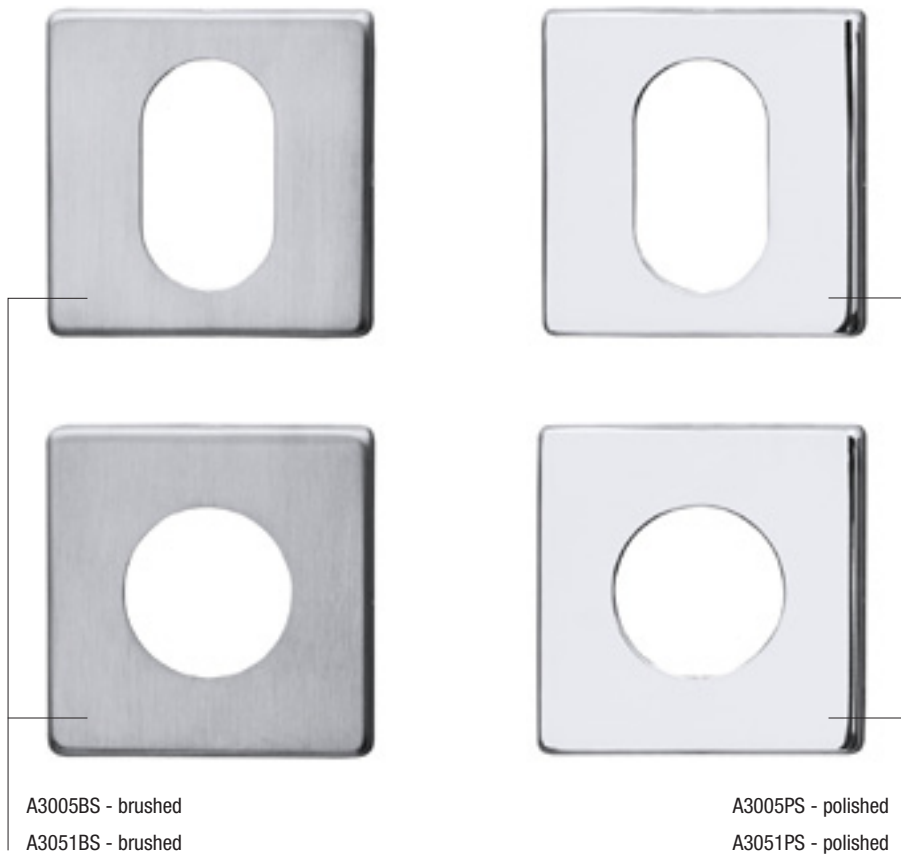

KUBE 3005 / 3051

Material: Stainless steel in brushed or polished.

What is in the box - A3005: A pair of ASSA key hole roses. 50 x 50 x 4 mm square rose covers with concealed screws and round fitted back plate. Machine screws (torx 15) M4 x 62 + M4 x 35 mm break-off. Wood screws 4,5 x 16 mm. Plastic tube plug. Rose key. Bushes.

What is in the box - A3051: A pair of square replacement cover roses for lever handles. 50 x 50 x 4 mm plate. 2 break-off screws, bushes and woods crews.

Design: Busk+Hertzog.

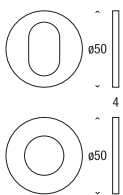
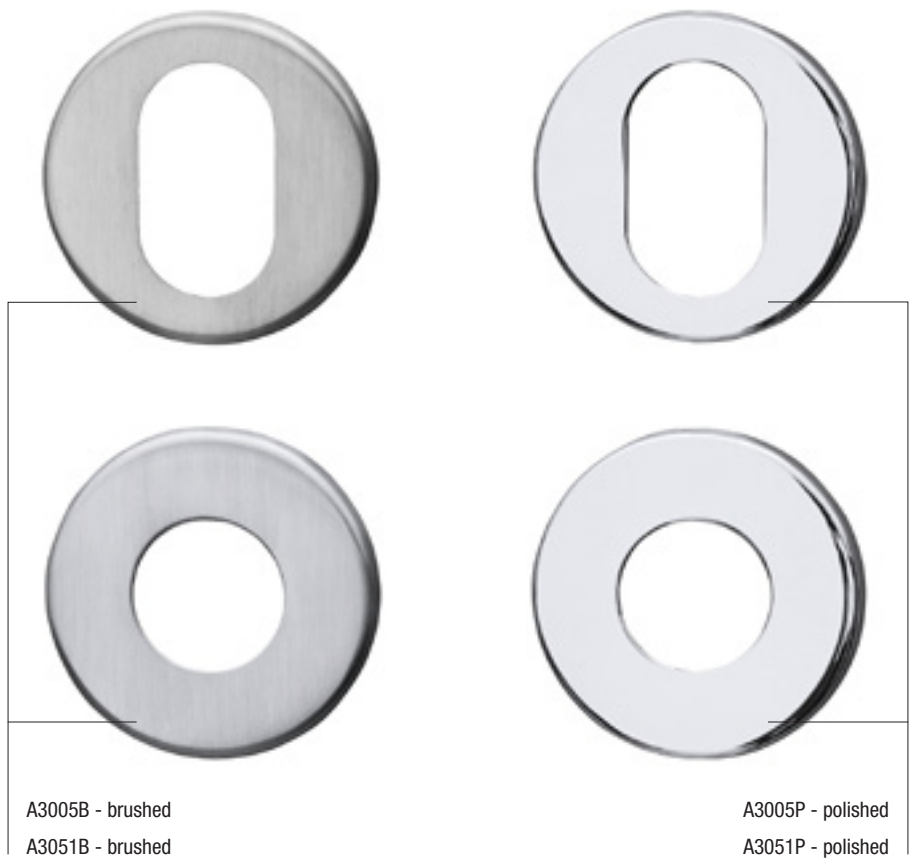

ELEMENT 3005 / 3051

Material: Stainless steel in brushed or polished.

What is in the box - A3005: A pair of ASSA key hole roses. Ø50 x 4 mm round rose covers with concealed screws and round fitted back plate.

Machine screws (torx 15) M4 x 62 + M4 x 35 mm break-off. Wood screws 4,5 x 16 mm. Plastic tube plug. Rose key. Bushes.

What is in the box - A3051: A pair of round replacement cover roses for lever handles. Ø50 x 4 mm.

WINDOW HANDLES

FEEL THE 'FROST' IN THE AIR







A4006BL - brushed

A4006BR - brushed

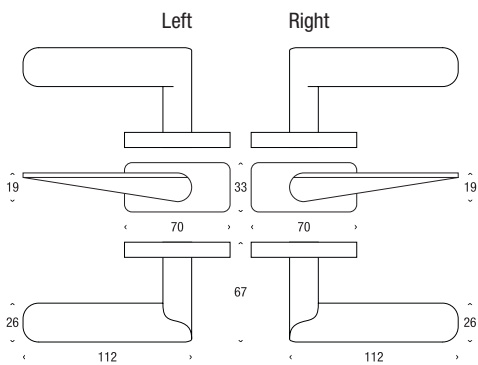



A4006PL - polished

A4006PR - polished

HB101 WINDOW LEFT / RIGHT

Material: Stainless Steel in brushed or polished.

What is in the box: 22,5 x 22,5 mm L-window handle with "hold" at 90° and 180° for turn and tilt. 70 x 33 x 9 mm square rose cover with concealed screws, drilled for M5 or 5 mm screws - CC 43 mm. 33 mm standard spindle 7 x 7 mm. M5 screws. Adapter for 8 x 8 mm spindle.

Design: Bønnelycke mdd.



A4001BS - brushed

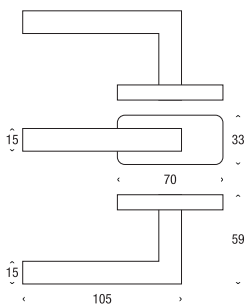



A4001PS - polished

KUBE 4001

Material: Stainless steel in brushed or polished.

What is in the box: 15 x 15 mm L-window handle with "hold" at 90° and 180° for turn and tilt. 70 x 33 x 9 mm square rose cover with concealed screws, drilled for M5 or 5 mm screws - CC 43 mm. 33 mm standard spindle 7 x 7 mm. M5 screws. Adapter for 8 x 8 mm spindle.

Design: Busk+Hertzog.



A4002BS - brushed

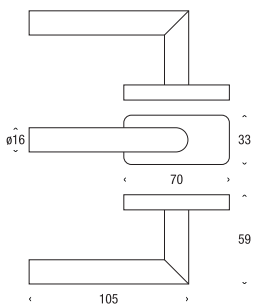



A4002PS - polished

KUBE 4002

Material: Stainless steel in brushed or polished.

What is in the box: Ø16mm L-window handle with "hold" at 90° and 180° for turn and tilt. 70 x 33 x 9 mm square rose cover with concealed screws, drilled for M5 or 5 mm screws - CC 43 mm. 33 mm standard spindle 7 x 7 mm. M5 screws. Adapter for 8 x 8 mm spindle.



A4003BS - brushed

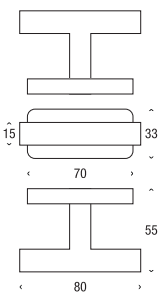



A4003PS - polished

KUBE 4003

Material: Stainless steel in brushed or polished.

What is in the box: 15 x 15 mm T-window handle with "hold" at 90° and 180° for turn and tilt. 70 x 33 x 9 mm square rose cover with concealed screws, drilled for M5 or 5 mm screws - CC 43 mm. 33 mm standard spindle 7 x 7 mm. M5 screws. Adapter for 8 x 8 mm spindle.

Design: Busk+Hertzog.



A4004BS - brushed

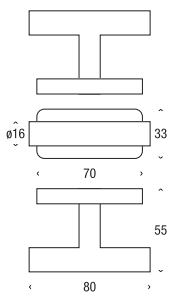



A4004PS - polished

KUBE 4004

Material: Stainless steel in brushed or polished.

What is in the box: Ø16 mm T-window handle with "hold" at 90° and 180° for turn and tilt. 70 x 33 x 9 mm square rose cover with concealed screws, drilled for M5 or 5 mm screws - CC 43 mm. 33 mm standard spindle 7 x 7 mm. M5 screws. Adapter for 8 x 8 mm spindle.



A4005BS - brushed

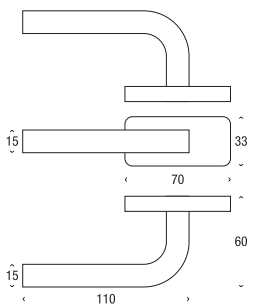



A4005PS - polished

KUBE 4005

Material: Stainless steel in brushed or polished.

What is in the box: 15 x 15 mm L-window handle with "hold" at 90° and 180° for turn and tilt. 70 x 33 x 9 mm square rose cover with concealed screws, drilled for M5 or 5 mm screws - CC 43 mm. 33 mm standard spindle 7 x 7 mm. M5 screws. Adapter for 8 x 8 mm spindle.

Design: Busk+Hertzog.



A4031BS - brushed

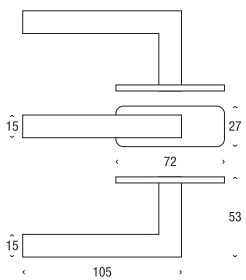



A4031PS - polished

KUBE 4031

Material: Stainless steel in brushed or polished.

What is in the box: 15 x 15 mm L-window handle, 72 x 27 x 4 mm square rose cover with concealed screws, CC 43 mm, 35 mm standard spindle 7 x 7 mm, M5 x 40 mm screws, Wood screws 4 x 25 mm, Adapter for 8 x 8 mm spindle, Allen key 2,5 mm.

Design: Busk+Hertzog.



A4032BL - brushed

A4032PL - polished

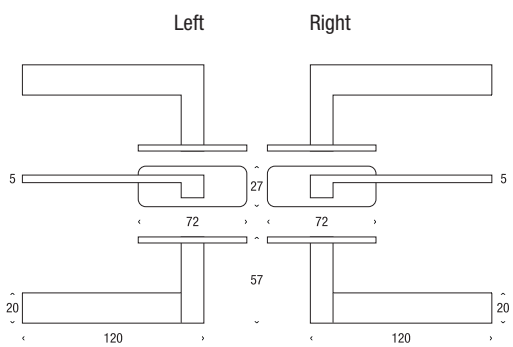



A4032BR - brushed

A4032PR - polished

KUBE 4032 LEFT / RIGHT

Material: Stainless steel in brushed or polished.

What is in the box: 20 x 5 mm left or right window handle. 72 x 27 x 4 mm square rose cover with concealed screws. CC 43 mm. 35 mm standard spindle 7 x 7 mm. M5 x 40 mm screws. Wood screws 4 x 25 mm. Adapter for 8 x 8 mm spindle. Allen key 2,5 mm.

Design: Busk+Hertzog.



A4033BS - brushed

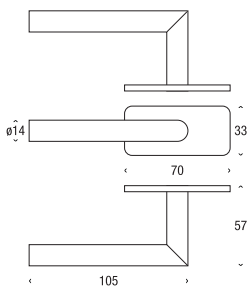



A4033PS - polished

KUBE 4033

Material: Stainless steel in brushed or polished.

What is in the box: Ø16 mm L-window handle. 72 x 27 x 4 mm square rose cover with concealed screws. CC 43 mm. 35 mm standard spindle 7 x 7 mm. M5 x 40 mm screws. Wood screws 4 x 25 mm. Adapter for 8 x 8 mm spindle. Allen key 2,5 mm.



A4034BL - brushed

A4034PL - polished

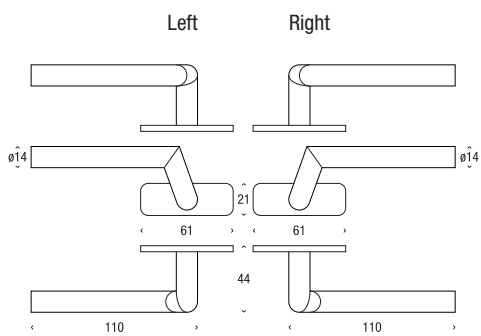



A4034BR - brushed

A4034PR - polished

KUBE 4034 LEFT / RIGHT

Materiale: Stainless steel in brushed or polished.

What is in the box: Ø14 mm cranked left or right window handle. 61 x 21 x 4 mm square rose cover with concealed screws. CC 43 mm. 35 mm standard spindle 8 x 8 mm. M5 x 40 mm screws. Wood screws 4 x 25 mm. Allen key 2,5 mm.

Design: Busk+Hertzog.



A4035BL - brushed

A4035PL - polished

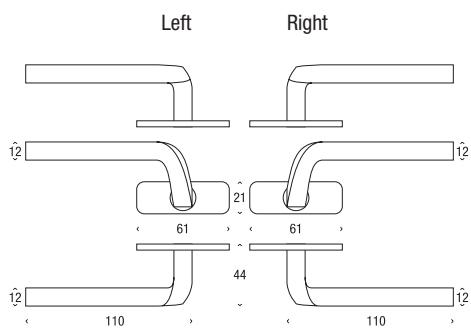



A4035BR - brushed

A4035PR - polished

KUBE 4035 LEFT / RIGHT

Material: Stainless steel in brushed or polished.

What is in the box: 12 x 12 mm cranked left or right window handle. 61 x 21 x 4 mm square rose cover with concealed screws.

CC 43 mm. 35 mm standard spindle 8 x 8 mm. M5 x 40 mm screws. Wood screws 4 x 25 mm. Allen key 2,5 mm.

Design: Busk+Hertzog.

DOOR STOPS

KEEPS DOORS AND WALLS FROM FIGHTING



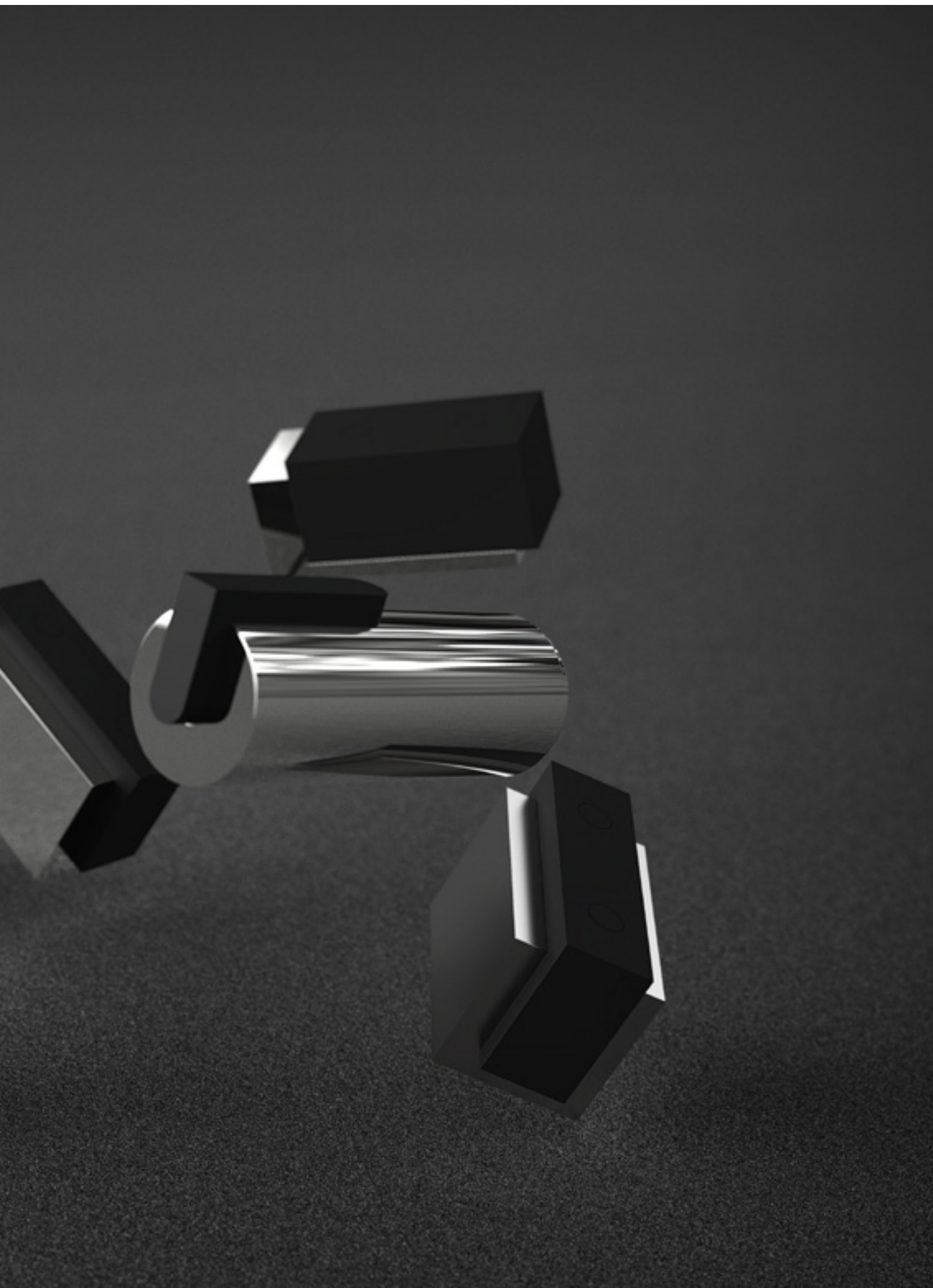



N1931 - brushed



O1931 - polished

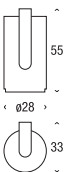

DOOR STOP 1931

Material: Stainless steel in brushed or polished.

What is in the box: A Ø28mm door stop with black rubber. 55mm high. Threaded brass insert. Wood screw and plugs.

Design: Bønnelycke mdd



N1931-1 - brushed



01931-1 - polished

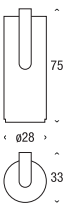

DOOR STOP 1931-1

Material: Stainless steel in brushed or polished.

What is in the box: A Ø28mm door stop with black rubber. 75mm high. Threaded brass insert. Wood screw and plugs.

Design: Bønnelycke mdd



A5001BS - brushed



A5001PS - polished

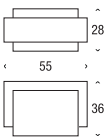

DOOR STOP 5001

Material: Stainless steel in brushed or polished.

What is in the box: A 38 x 70 mm door stop with black rubber buffer 26 x 70 mm - 51 mm high. For wall or floor mounting. Wood screws and plugs.

Design: Busk+Hertzog.



A5002BS - brushed



A5002PS - polished

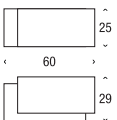

DOOR STOP 5002

Material: Stainless steel in brushed or polished.

What is in the box: A 40 x 89 mm door stop with black rubber buffer 40 x 80 mm - 51 mm high. For wall or floor mounting. Wood screws and plugs.

Design: Busk+Hertzog.



A5005BS - brushed



A5005PS - polished

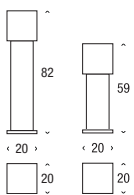

DOOR STOP 5004 / 5005

Material: Stainless steel in brushed or polished.

What is in the box 5004: One 20x20 mm door stop with back plate black rubber buffer 20x20 mm - 82 mm high. Threaded brass insert and wood screw and plugs.

What is in the box 5005: One 20x20 mm door stop with back plate black rubber buffer 20x20 mm - 59 mm high. Threaded brass insert and wood screw and plugs.



A5051B - brushed

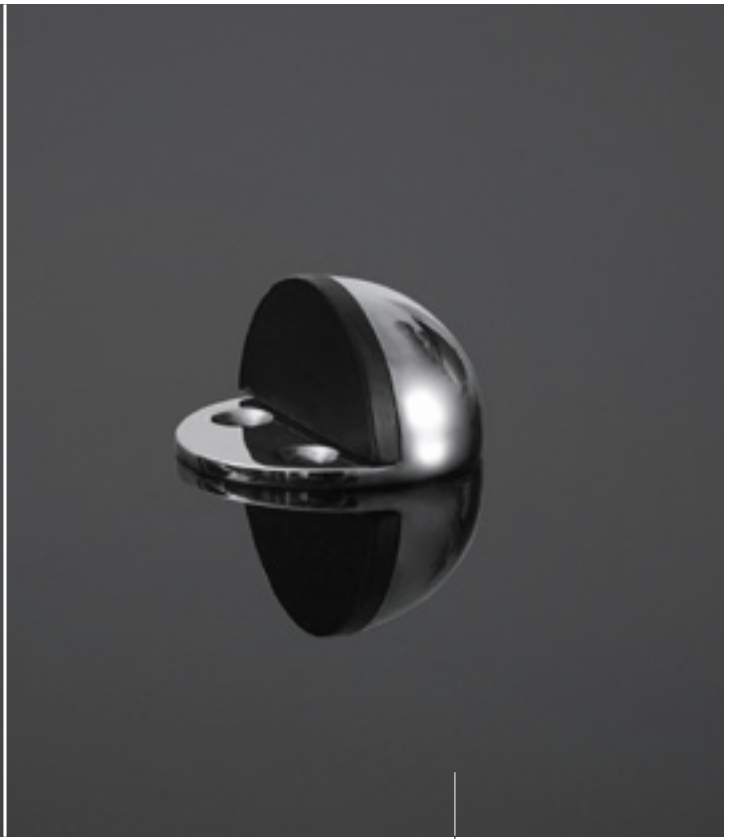

A5051P - polished

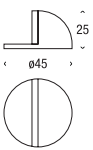

DOOR STOP 5051

Material: Stainless steel in brushed or polished.

What is in the box: A Ø45 mm door stop with black rubber buffer. Drilled for Ø5,5 mm screws. Wood screws and plugs.



A5052B - brushed



A5052P - polished

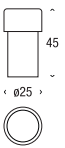

DOOR STOP 5052

Material: Stainless steel in brushed or polished.

What is in the box: A Ø20 mm door stop with black rubber buffer Ø25mm - 45 mm high. Threaded brass insert. Wood screw and plugs.



A5053B - brushed



A5053P - polished

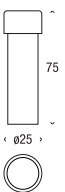

DOOR STOP 5053

Material: Stainless steel in brushed or polished.

What is in the box: A $\varnothing 20$ mm door stop with black rubber buffer $\varnothing 25$ mm - 75 mm high. Threaded brass insert. Wood screw and plugs.



PUSH PULL HANDLES

YOUR EVERYDAY WORKOUT



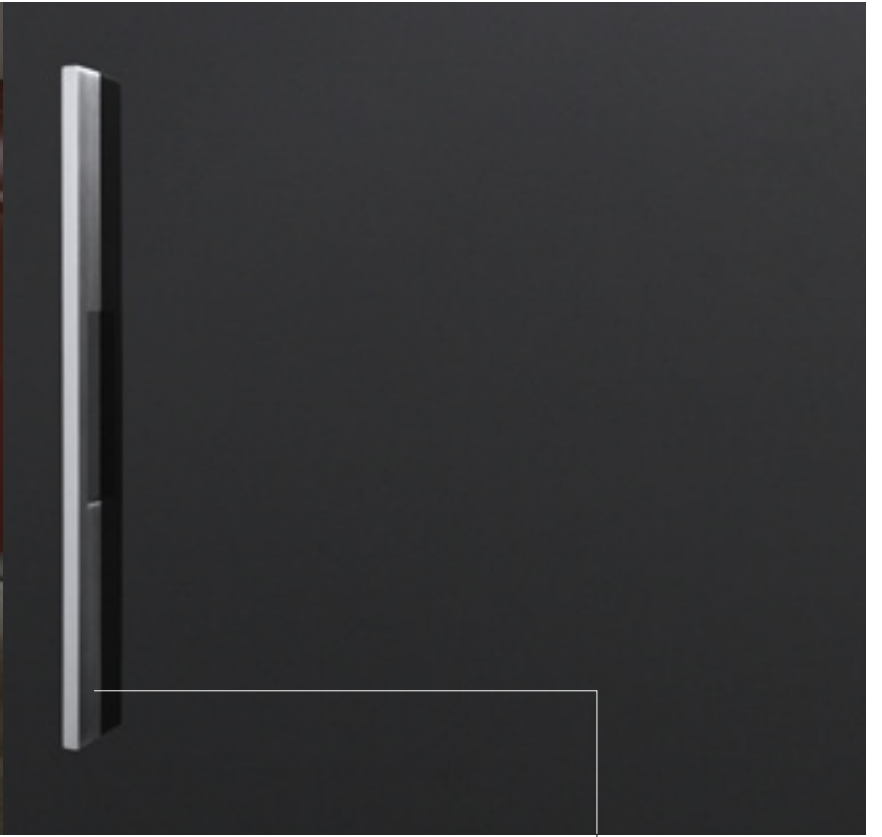

A8002B brushed

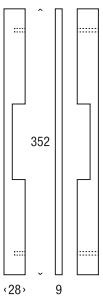

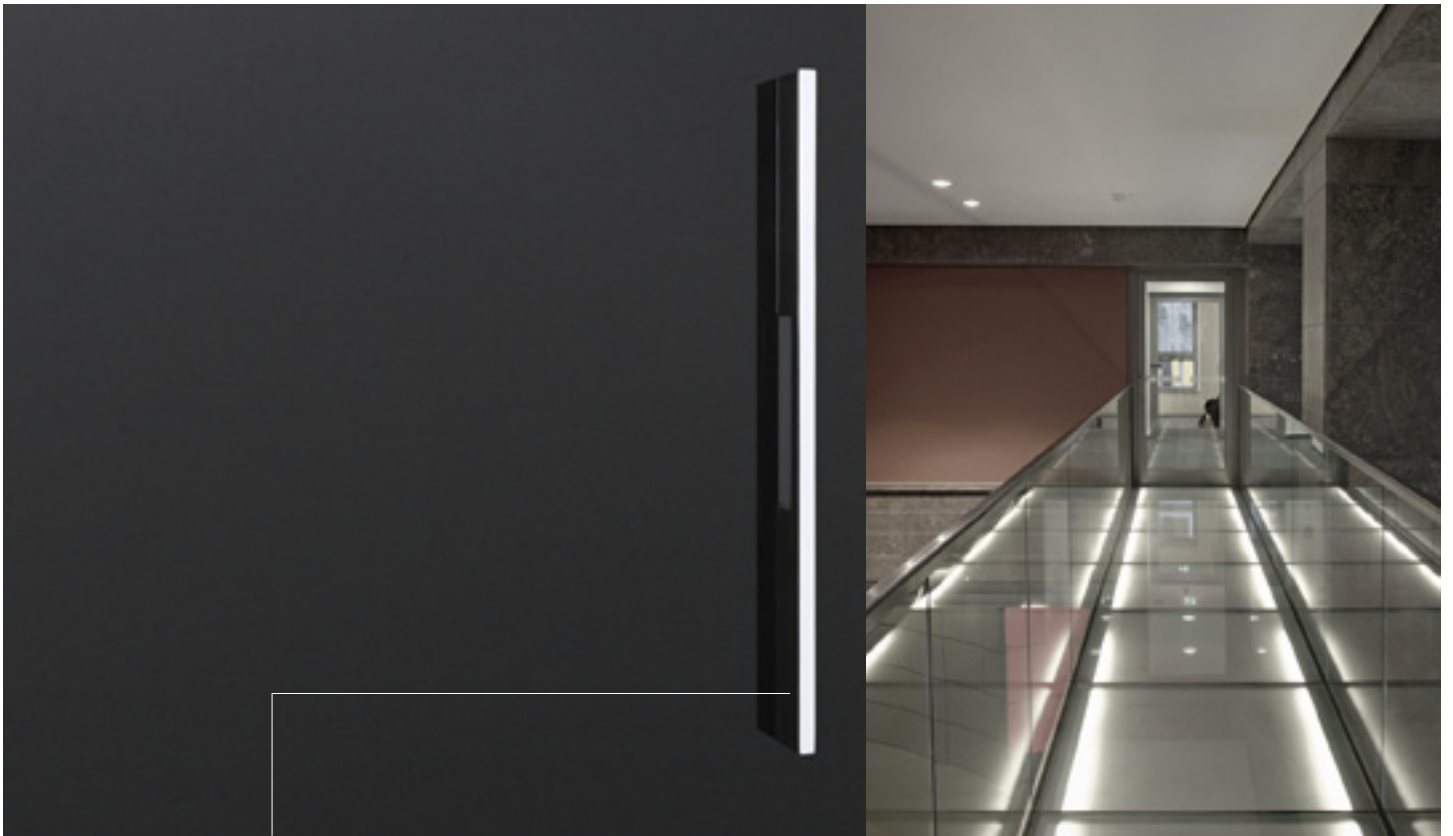

A8002P - polished

ARKI+® 8002

Material: Aluminium in brushed or polished finish.

What is in the box: A pair of ARKI+® profile push/pull handles. 2 x break-off screws M4 x 60 mm (torx 15). Plastic washers and plastic tube.

Design: Busk+Hertzog.



A8003B-300 - brushed
A8003B-450 - brushed
A8003B-600 - brushed

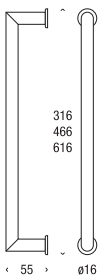



A8003P-300 - polished

A8003P-450 - polished

A8003P-600 - polished

ELEMENT 8003

Material: Stainless steel in brushed or polished.

Lengths: 316 mm brushed (art. no. A8003b-300), 466 mm brushed (art. no. A8003b-450), 616 mm brushed (art. no. A8003b-600), 316 mm polished (art. no. A8003p-300), 466 mm polished (art. no. A8003p-450), 616 mm polished (art. no. A8003p-600).

What is in the box: A pair of Ø16 mm push/pull handles with Ø25 x 3 mm round roses. Machine screws M6 x 76 mm, brass insert, set screw and rubber washers for Ø7 mm hole. Plastic tube.



A8004B-300 - brushed
A8004B-450 - brushed
A8004B-600 - brushed

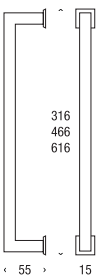



A8004P-300 - polished

A8004P-450 - polished

A8004P-600 - polished

KUBE 8004

Material: Stainless steel in brushed or polished.

Lengths: 315 mm brushed (art. no. A8004B-300), 465 mm brushed (art. no. A8004B-450), 615 mm brushed (art. no. A8004B-600), 315 mm polished (art. no. A8004P-300), 465 mm polished (art. no. A8004P-450), 615 mm polished (art. no. A8004P-600).

What is in the box: A pair of 15 x 15 mm push/pull handles with 26 x 26 x 3 mm square roses. Machine screws M6 x 76 mm, brass insert, set screw and rubber washers for Ø7 mm hole. Plastic tube.





ACCESSORIES

'PIMP' YOUR HOME



A6051B - brushed

A6052B brushed

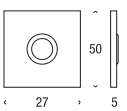
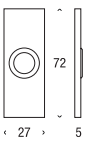



A6051P - polished

A6052P - polished

DOOR BELL KUBE 6051

Material: Stainless steel in brushed or polished.

What is in the box: Door bell with 72 x 27 x 4 mm rectangular cover rose with concealed screws. Wood screws and plugs.

Material: Busk+Hertzog.

DOOR BELL KUBE 6052

Material: Stainless steel in brushed or polished.

What is in the box: Door bell with 50 x 50 x 4 mm square cover rose with concealed screws. Wood screws and plugs.

Material: Busk+Hertzog.

DESIGNERS



BUSK+HERTZOG

"Behind every product lies a story. Sometimes it's obvious and can be read in the visual appearance of the product, and sometimes it is subtle and to be found in the detail. But the story is always there" Flemming Busk and Stephan Hertzog established their successful studio in Denmark in 2000. Today, their recognition goes far beyond Scandinavian borders.

Their studio has won more than 20 of the most prestigious international design awards, including Red Dot Awards, IF Awards and Good Design Awards, making them the most award-winning Danish designers of their generation. Several of their designs are part of permanent exhibitions at design museums around the world. busk+hertzog's design characteristics are sculptural, clean lines and a simple expression with minimal embellishment. Any decoration usually serves a function or is integral to the furniture. They often get their inspiration from shapes and lines found in nature.

When Flemming Busk and Stephan Hertzog established their design studio, it was with a very clear vision of being not only innovative and professional but also with the aim of launching a new generation of Danish Designers. Their successful revitalizing of a Danish Design industry that was mainly based on designs from the 1950's was recognized in 2008 by the Danish furniture industry who awarded them with their oldest and finest distinction – The Industry's Furniture Award. This was previously given to, among others, Arne Jacobsen, Poul Kjærholm, Verner Panton and Jørn Utzon.

Their products have been used in some of the world's most prestigious building projects - perhaps not surprising given that Stephan B. Hertzog and Flemming Busk always have had an emphasis on their designs being global. The design duo is now based in London.



BØNNELYCKE MDD

Bønnelycke MDD was established in 1988. Driven by an unsurpressable urge and desire to work constructively and innovatively, Henrik Bønnelycke started his career with the design of lamps, furniture and interior decorating. Quickly, he became known as an unconventional architect with no whims and fancies. His ability to challenge and optimize the manufacturing process itself is to be found in Henrik's original professional background as a toolmaker.

"It could be fun" and "of course it can be done" – are phrases often used in his company.

This has resulted in a comprehensive portfolio of projects and designs - spectacle frame design, racing boats, lighting, furniture and buildings to name a few - several of them award winning and patented designs.

Bønnelycke MDD is truly a multi disciplinary design company with both national and international experience.

They are perfectionists with professional curiosity, and provide a wide variety of design disciplines encompassing architecture and interior design, furniture design and product design to communication assignments, graphic design and web design.

At Bønnelycke MDD they do not design for the sake of it. They believe that design does not hold any values per se. To Bønnelycke, the value of a design emerges when a product has relevance and when it is purchased, used and appreciated - this is why they design.

In Bønnelycke's own words: "We are committed to providing our clients with what they pay for – which is their own design!"

INDEX

BY PRODUCT TYPE, ARTICLE NUMBER, NAME AND PAGE

DOOR HANDLES AND KNOBS	Article No.	Name	P9
	A1001 B/P	Element 1001 / Oslo	p17
	A1001 BS/PS	Kube 1001 / Oslo	p19
	A1002 BS/PS	Kube 1002 / Stockholm	p21
	A1003 BS/PS	Kube 1003 / Copenhagen	p23
	A1004 BS/PS	Kube 1004 / Berlin	p25
	A1005 BS/PS	Kube 1005 / Amsterdam	p27
	A1006 BS/PS	Kube 1006 / Bruxelles	p29
	A1051 B/P	Tube 1051 / Vienna 16mm	p31
	A1052 B/P	Tube 1052 / Vienna 19mm	p33
	A1053 B/P	Element 1053 / Helsinki 16mm	p35
	A1053 BS/PS	Element 1053 / Helsinki 16mm	p37
	A1054 B/P	Element 1054 / Helsinki 19mm	p39
	A1054 BS/PS	Element 1054 / Helsinki 19mm	p41
	A1007 B/P	HB101 Door	p11
	A1007 SB/SP	HB101 Door Small	p13
	A1008 B/P	HB102 Door	p15
	A6001 B/P	Kube 6001	p43
	A6002 B/P	Kube 6002	p45
	A6002 BS/PS	Kube 6003	p47

ESCUCHEONS	Article No.	Name	P49
	A2001	Element 2001	p56
	A2001.modul	Element 2001 Modul	p57
	A2001S	Kube 2001	p50
	A2001S.modul	Kube 2001 Modul	p51
	A2002S	Kube 2002	p52
	A2003S	Kube 2003	p53
	A2003	Element 2003	p58
	A2004	HB202	p54
	A2004.modul	HB202 Modul	p55
	A3001	Element 3001	p62
	A3001S	Kube 3001	p63
	A3002	Element 3001	p62
	A3002S	Kube 3001	p63
	A3003	Element 3003	p64
	A3003S	Kube 3003	p65
	A3004	Element 3004	p64
	A3004S	Kube 3004	p65
	A3005	Element 3005	p66
	A3005S	Kube 3005	p67

...continued	A3051	Element 3005	p66
	A3051S/S	Kube 3005	p67
	A3006	Element 3006	p59
	A3006S	Kube 3006	p60
	A3007S	Kube 3007	p61
WINDOW HANDLES	Article No.	Name	P69
	A4001S	Kube 4001	p73
	A4002S	Kube 4002	p75
	A4003S	Kube 4003	p77
	A4004S	Kube 4004	p79
	A4005S	Kube 4005	p81
	A4006L/R	HB101 Window Left / Right	p70
	A4031S	Kube 4031	p83
	A4032L/R	Kube 4032 Left / Right	p85
	A4033	Kube 4033	p87
	A4034L/R	Kube 4034 Left / Right	p89
	A4035L/R	Kube 4035 Left / Right	p91
DOOR STOPS	Article No.	Name	P93
	1931	Door stopper 1931	p100
	1931-1	Door stopper 1931-1	p101
	A5001S	Door stopper 5001	p94
	A5002S	Door stopper 5002	p95
	A5005S	Door stopper 5002	p96
	A5051	Door stopper 5051	p97
	A5052	Door stopper 5052	p98
	A5053	Door stopper 5053	p99
PUSH PULL HANDLES	Article No.	Name	P103
	A8002	Arki + 8002	p105
	A8003-300/400/600	Element 8003	p107
	A8004-300/400/600	Kube 8004	p109
ACCESSORIES	Article No.	Name	P111
	A6051	Kube 6051	p113
	A6052	Kube 6052	p113

Graphic design by Bønnelycke mdd

Photography by Busk + Hertzog, Bønnelycke mdd, Shutterstock.

Printed in 2013 by CS Grafisk.

Copyright © 2013

All rights reserved

No part of this publication may be reproduced or transmitted in any form or by any means, electronic or mechanical, including photocopy, recording or any other information storage and retrieval system, without prior permission from FROST A/S. We reserve the right to make alterations to the models without prior notice.



FROST

FROST A/S
BAVNE ALLÉ 6E
DK - 8370 HADSTEN

T » +45 8761 0032
F » +45 8761 0034

INFO@FROSTDESIGN.DK
WWW.FROSTDESIGN.DK